

Packaging methods (Taping)

● Standard quantity

Series	Size code (inch size)	Thickness (mm)	Kind of taping	Pitch (mm)	Quantity (pcs/reel)
EZJZ, EZJP	Z(0201)	0.3	Pressed carrier taping	2	15000
	0(0402)	0.5			10000
	1(0603)	0.8	Punched carrier taping	4	4000
EZJS	1(0603)	0.8			4000
	2(0805)	0.8			5000
		1.25	Embossed carrier taping		2000

● 2 mm Pitch (Pressed carrier taping) Size 0201

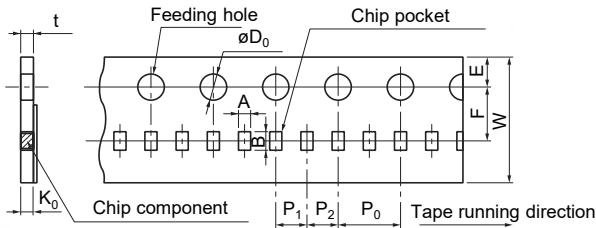

Unit : mm

Code	A	B	W	F	E	P ₁	P ₂	P ₀	øD ₀	t	K ₀
EZJZ EZJP	0.36 ±0.03	0.66 ±0.03	8.0 ±0.2	3.50 ±0.05	1.75 ±0.10	2.00 ±0.05	2.00 ±0.05	4.0 ±0.1	1.5 +0.1 0	0.55 max	0.36 ±0.03

● 4 mm pitch (Embossed carrier taping) Size 0805

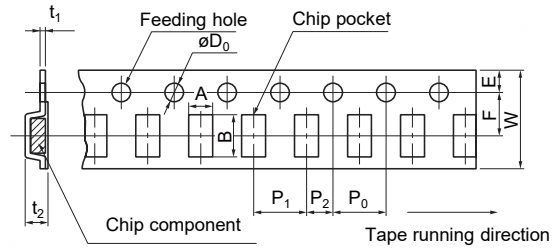

Unit : mm

Code	A	B	W	F	E	P ₁	P ₂	P ₀	øD ₀	t ₁	t ₂
EZJS	1.55 ±0.20	2.35 ±0.20	8.0 ±0.2	3.50 ±0.05	1.75 ±0.10	4.0 ±0.1	2.00 ±0.05	4.0 ±0.1	1.5 +0.1 0	0.6 max	1.5 max

● 2 mm Pitch (Punched carrier taping) Size 0402

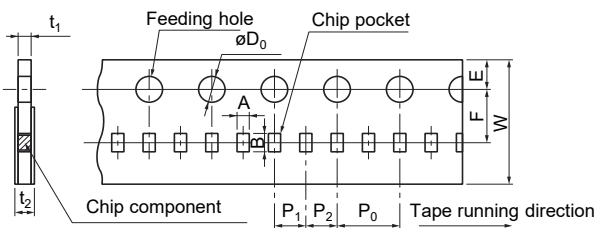

Unit : mm

Code	A	B	W	F	E	P ₁	P ₂	P ₀	øD ₀	t ₁	t ₂
EZJZ EZJP EZJS	0.62 ±0.05	1.12 ±0.05	8.0 ±0.2	3.50 ±0.05	1.75 ±0.10	2.00 ±0.05	2.00 ±0.05	4.0 ±0.1	1.5 +0.1 0	0.7 max	1.0 max

● Reel for taping

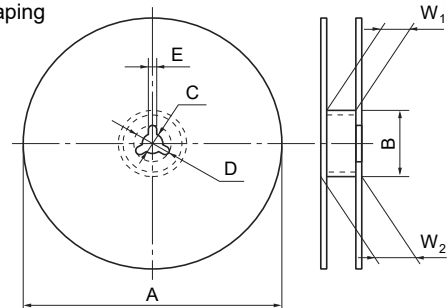

Unit : mm

Code	A	B	C	D	E	W ₁	W ₂
EZJZ EZJP EZJS	ø180 ⁰ ₋₃	ø60.0 ^{+1.0} ₀	13.0 _{±0.5}	21.0 _{±0.8}	2.0 _{±0.5}	9.0 ^{+1.0} ₀	11.4 _{±1.0}

● 4 mm Pitch (Punched carrier taping)

Size 0603, 0805, 0504/2 Array

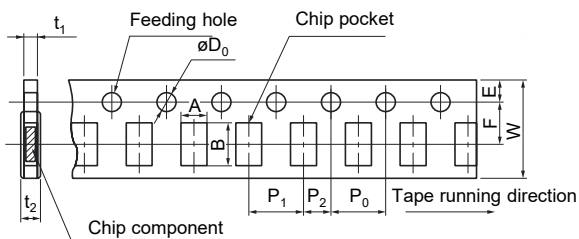

Unit : mm

Size code (inch size)	A	B	W	F	E	P ₁	P ₂	P ₀	øD ₀	t ₁	t ₂
1 (0603)	1.0 ±0.1	1.8 ±0.1	8.0 ±0.2	3.50 ±0.05	1.75 ±0.10	4.0 ±0.1	2.00 ±0.05	4.0 ±0.1	1.5 +0.1 0	1.1 max	1.4 max
S (0504 2 Array)	1.18 ±0.10	1.63 ±0.10									
2 (0805)	1.65 ±0.20	2.4 ±0.2									

● Leader part and taped end

Leader part

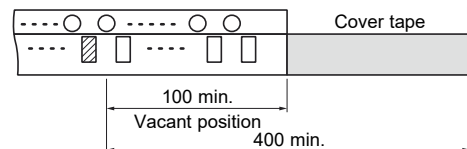

Tape end

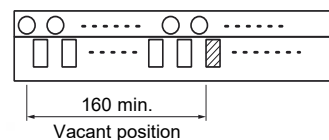

Unit : mm