

PAN1780

Bluetooth[®] Low Energy Module
Module Integration Guide

Rev. 1.1



Overview

The PAN1780 is a Bluetooth 5 Low Energy (LE) module based on the Nordic nRF52840 single chip controller.

Features

- Surface mount type dimensions: 15.6 mm x 8.7 mm x 2 mm
- Same form factor as PAN1026A and PAN1762 but smaller pitch and more pins
- Nordic nRF52840 featuring ARM® Cortex®-M4F with 64 MHz
- Bluetooth 5 LE including LE 2M and LE Coded PHY
- Embedded 1 MB flash memory and 256 kB internal RAM
- Includes ARM TrustZone® CryptoCell® 310 and supports secure boot including Root of Trust (RoT)
- Up to 48 General Purpose I/Os (GPIO), which are shared by up to 4 SPI, 2 I²C, 2 UART, 4 PWM, 8 ADC, 1 NFC-A, 32 kHz IN/OUT, nRESET
- USB 2.0 full-speed device interface
- Built in temperature sensor

Bluetooth

- LE 2 Mbps high speed PHY, LE long range coded PHY
- LE advertising extensions (advertising on 40 channels total)
- Channel selection algorithm #2
- LE secure connections
- Over-the-air update of application software
- Qualified Bluetooth mesh profile stack

Characteristics

- Typical sensitivity: -95 dBm at 1 Mb/s and -103 dBm at 125 kb/s
- Typical max. output power: 8 dBm, configurable from -20 dBm in 4 dB steps and -40 dBm in whisper mode
- Typical current consumption: 4.8 mA in Tx (at 0 dBm) and 4.8 mA in Rx mode
- Typical current consumption: 0.4 µA in System OFF mode, 1.5 µA with RTC wake up
- On-module DC/DC and LDO regulators with automated low current modes
- Voltage range: 1.7 V to 5.5 V
- Temperature range: -40 °C to 85 °C

Block Diagram

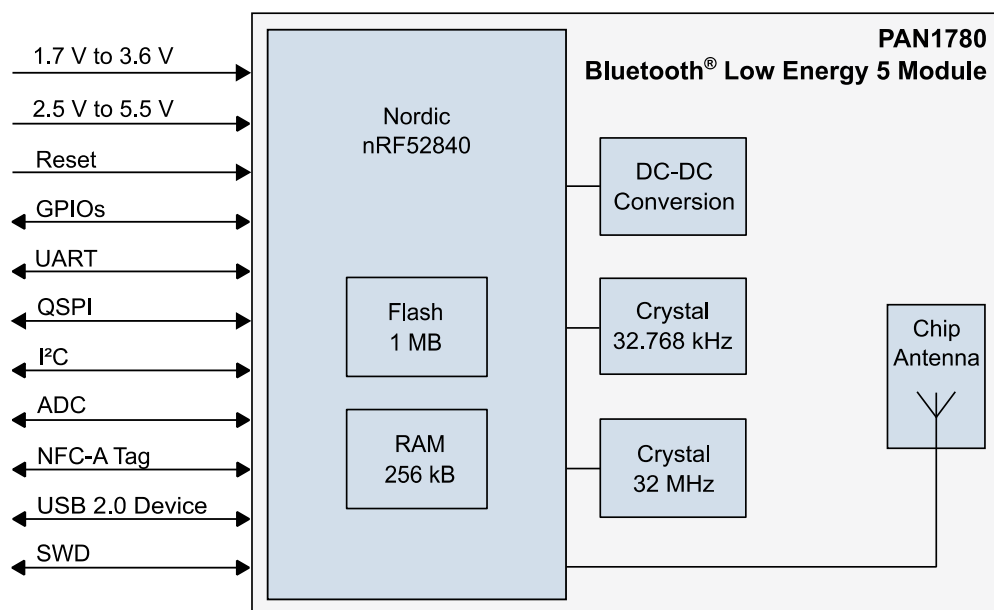

By purchase of any of the products described in this document the customer accepts the document's validity and declares their agreement and understanding of its contents and recommendations. Panasonic Industrial Devices Europe GmbH (Panasonic) reserves the right to make changes as required at any time without notification. Please consult the most recently issued Module Integration Guide before initiating or completing a design.

© Panasonic Industrial Devices Europe GmbH 2020.

This specification sheet is copyrighted. Reproduction of this document is permissible only if reproduction is without alteration and is accompanied by all associated warranties, conditions, limitations, and notices. Do not disclose it to a third party.

All rights reserved.

This Module Integration Guide does not lodge the claim to be complete and free of mistakes.

Engineering Samples (ES)

If Engineering Samples are delivered to the customer, these samples have the status "Engineering Samples". This means that the design of this product is not yet concluded. Engineering Samples may be partially or fully functional, and they may differ from the published Product Specification.

Engineering Samples are not qualified and they are not to be used for reliability testing or series production.

Disclaimer

The customer acknowledges that samples may deviate from the Module Integration Guide and may bear defects due to their status of development and the lack of qualification mentioned above.

Panasonic rejects any liability or product warranty for Engineering Samples. In particular, Panasonic disclaims liability for damages caused by:

- The use of the Engineering Sample other than for evaluation purposes, particularly the installation or integration in another product to be sold by the customer,
- Deviation or lapse in function of the Engineering Sample,
- Improper use of the Engineering Sample.

Panasonic Industrial Devices Europe GmbH disclaims any liability for consequential and incidental damages. In case of any queries regarding the Engineering Samples, please contact your local sales partner or the related product manager.

The information contained herein is presented only as guidance for Product use. No responsibility is assumed by Panasonic for any infringement of patents or any other intellectual property rights of third parties that may result from the use of Product. No license to any intellectual property right is granted by this document, whether express or implied, by estoppel or otherwise.

Description of hardware, software, and other information in this document is only intended to illustrate the functionality of the referred Panasonic product. It should not be construed as guaranteeing specific functionality of the product as described or suitable for a particular application.

Any provided (source) code shall not be used or incorporated into any products or systems whose manufacture, use or sale is prohibited under any applicable laws or regulations.

Any outlined or referenced (source) code within this document is provided on an "as is" basis without any right to technical support or updates and without warranty of any kind on a free of charge basis according to § 516 German Civil Law (BGB) including without limitation, any warranties or conditions of title, non infringement, merchantability, or fitness for a particular purpose. Customer acknowledges that (source) code may bear defects and errors.

The third-party tools mentioned in this document are offered by independent third-party providers who are solely responsible for these products. Panasonic has no responsibility whatsoever for the performance, product descriptions, specifications, referenced content, or any and all claims or representations of these third-party providers. Panasonic makes no warranty whatsoever, neither express nor implied, with respect to the goods, the referenced contents, or any and all claims or representations of the third-party providers. To the maximum extent allowable by Law Panasonic assumes no liability whatsoever including without limitation, indirect, consequential, special, or incidental damages or loss, including without limitation loss of profits, loss of opportunities, business interruption, and loss of data.

Table of Contents

1	About This Document	6
1.1	Purpose and Audience.....	6
1.2	Revision History	6
1.3	Use of Symbols	6
1.4	Related Documents	7
2	Overview.....	8
3	PAN1780 Module	9
3.1	Block Diagram.....	9
3.2	Footprint.....	10
3.3	Placement	11
4	Reference Design	13
4.1	Block Diagram.....	13
4.2	Schematic	14
4.3	Building Blocks.....	15
4.4	Breakout Pins.....	15
4.5	Configuration Settings.....	16
4.6	NFC Antenna Placement	18
4.7	PCB Layout.....	18
5	Getting Started	21
5.1	Default Jumper Configuration.....	21
5.2	Device Drivers.....	21
5.3	Software Examples.....	22
5.4	Getting Toolchain	22
5.5	Getting Started	29
6	Regulatory and Certification Information	34
6.1	General Certification Information.....	34
6.2	Federal Communications Commission (FCC) for US.....	34
6.3	Innovation, Science, and Economic Development (ISED) for Canada.....	37
6.4	European Conformity According to RED (2014/53/EU).....	41
6.5	Bluetooth.....	42
7	Restricted Use.....	43
7.1	Life Support Policy.....	43
7.2	Restricted End Use.....	43
8	Contact Details	44
8.1	Contact Us	44
8.2	Product Information	44

1 About This Document

1.1 Purpose and Audience

This Module Integration Guide is intended to support the easy integration of the PAN1780 into a product and to ensure the compliance with regulatory requirements.

This guide gives an overview about the hardware design requirements by providing a reference design, which is the evaluation board of the PAN1780. It describes how to use the PAN1780 on the evaluation board with the software packages and tools provided by Nordic Semiconductors. In addition, it explains how to start up the evaluation board, get all the needed software sources, execute example code and build own implementations.

It is intended for hardware design, application, and Original Equipment Manufacturers (OEM) engineers.



Please read this guide carefully to assure the compliance of your product to regulatory.

The product is referred to as “the PAN1780” or “the module” within this document.

1.2 Revision History

Revision	Date	Modifications/Remarks
1.0	2020-03-12	First preliminary version
1.1	2020-04-27	Updated chapter “General Certification Information”: added SoftDevice S113. Updated chapter “Innovation, Science, and Economic Development (ISED) for Canada”: added ISED SAR Warning and HVIN. Updated chapter “Bluetooth”: added Bluetooth ID.

1.3 Use of Symbols

Symbol	Description
	Note Indicates important information for the proper use of the product. Non-observance can lead to errors.
	Attention Indicates important notes that, if not observed, can put the product’s functionality at risk.
	Tip Indicates useful information designed to facilitate working with the module and software.
⇒ [chapter number] [chapter title]	Cross reference Indicates cross references within the document. Example: Description of the symbols used in this document ⇒ 1.3 Use of Symbols .

Symbol	Description
✓	<p>Requirement</p> <p>Indicates a requirement that must be met before the corresponding tasks can be completed.</p>
➔	<p>Result</p> <p>Indicates the result of a task or the result of a series of tasks.</p>
This font	<p>GUI text</p> <p>Indicates fixed terms and text of the graphical user interface.</p> <p>Example:</p> <p>Click Save.</p>
Menu > Menu item	<p>Path</p> <p>Indicates a path, e.g. to access a dialog.</p> <p>Example:</p> <p>In the menu, select File > Setup page.</p>
This font	<p>File names, messages, user input</p> <p>Indicates file names or messages and information displayed on the screen or to be selected or entered by the user.</p> <p>Examples:</p> <p>pan1760.c contains the actual module initialization.</p> <p>The message Failed to save your data is displayed.</p> <p>Enter the value Product 123.</p>
Key	<p>Key</p> <p>Indicates a key on the keyboard, e.g. F10.</p>

1.4 Related Documents

For related documents please refer to the Panasonic website ⇒ [8.2 Product Information](#).

2 Overview

The PAN1780 is a Bluetooth 5 Low Energy (LE) module based on the Nordic nRF52840 single-chip controller.

The Bluetooth 5 features additionally a higher symbol rate of 2 Mbps using the high-speed LE 2M PHY or a significantly longer range using the LE coded PHY at 500 kb/s or 125 kb/s. The new channel selection algorithm (CSA#2) improves the performance in high interference environments. Furthermore, the new LE advertising extensions allow for much larger amounts of data to be broadcasted in connectionless scenarios.

An output power of up to 8 dBm and the high sensitivity of the nRF52840 in combination with the LE coded PHY makes the module very attractive in applications, where a long range is required.

In addition the ultra-low current consumption of the PAN1780 makes the module an ideal choice for battery powered devices.

With the Cortex[®] M4F processor, 256 kB RAM and the build-in 1 MB flash memory the PAN1780 can easily be used in standalone mode, thereby eliminating the need for an external processor, saving complexity, space, and cost.

The rich set of security features from the ARM TrustZone CryptoCell 310 security subsystem provide the necessary means for secure device operation in the IoT space.

The PAN1780 also supports Type 2 Near Field Communication (NFC-A) for use in simplified pairing and payment solutions (external antenna required).

For related documents please refer to [⇒ 8.2 Product Information](#).

3 PAN1780 Module

3.1 Block Diagram

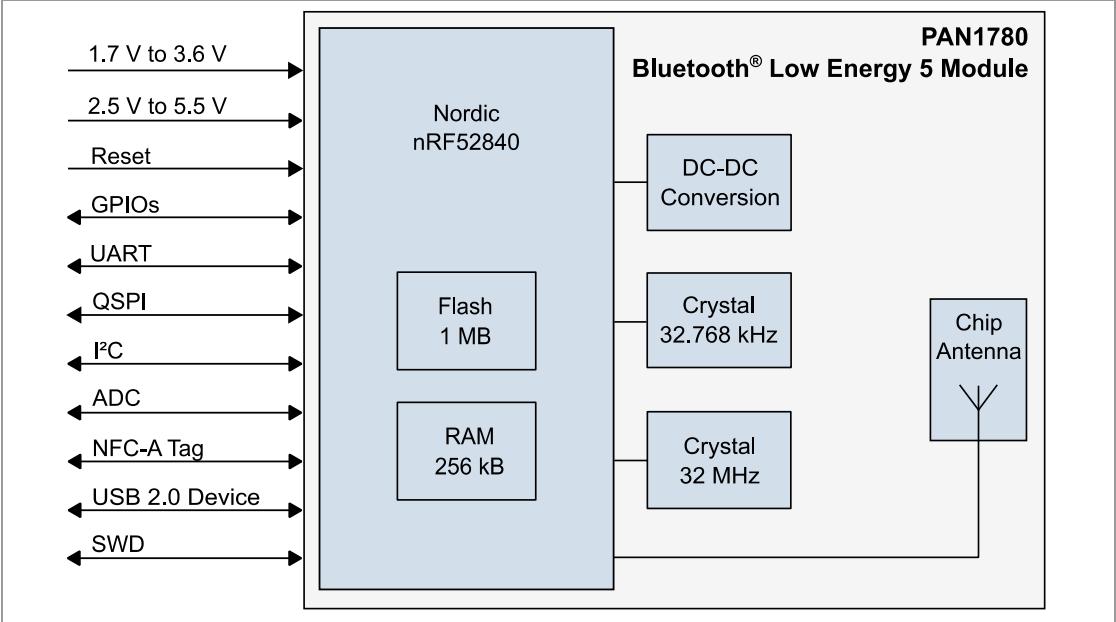

3.2 Footprint

 The dimensions are in millimeters.
The outer dimensions have a tolerance of ± 0.3 mm.

Top View

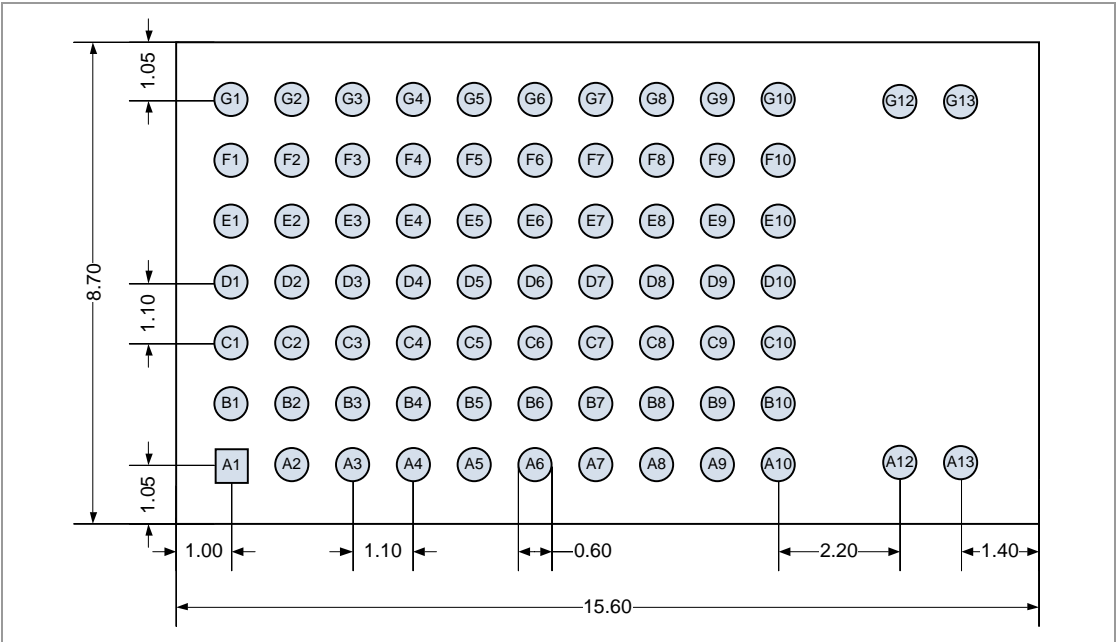

3.3 Placement



Antenna “Keep out Area”

Do not place any ground plane under the marked restricted antenna area in any layer! This would be affecting the performance of the chip antenna in a critical manner.



Impact of Placement on the Antenna Radiation Pattern

The placement of the module, surrounding material, and customer components has an impact on the radiation pattern of the antenna.



The recommendation for the ground plane is based on a FR4 4-Layer PCB.

The following requirements must be met:

- ✓ Keep this product away from heat. Heat is the major cause of decreasing the life of these products.
- ✓ Keep this product away from other high frequency circuits.

The antenna requires a cutout area of 5 mm x 3 mm under the PAN1780 module. This “Keep out Area” shall be located in every layer under the module antenna. Note for example the “Keep out Area” in all four layers of the PAN1780 evaluation board.

It is recommended to verify the perfect position of the module in the target application before fixing the design.

 All dimensions are in millimeters.

 Use a ground plane in the area surrounding the module wherever possible.

It is recommended to place the module:

- In the center (horizontal) of mother PCB.
- At the edge (horizontal) of mother PCB.

Antenna Placement Recommendation

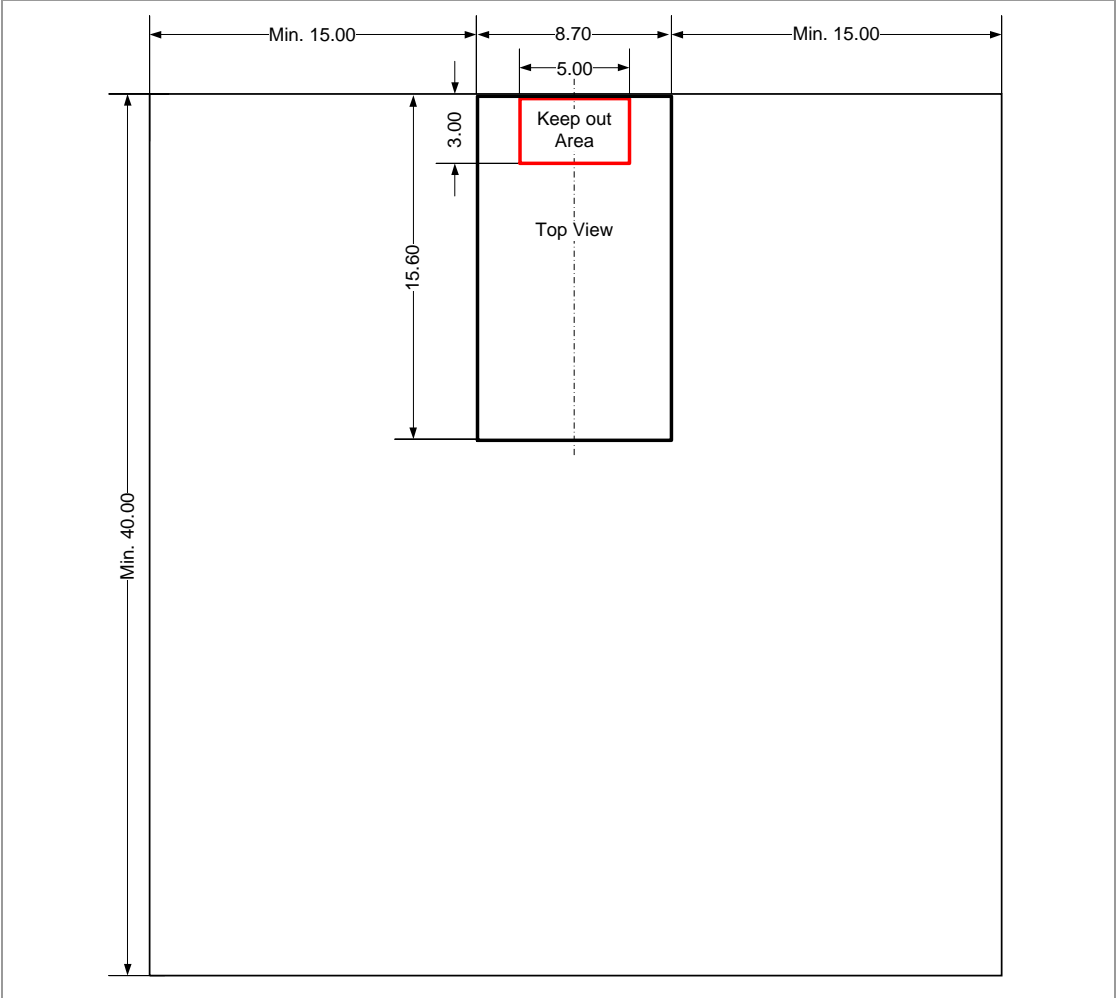

4 Reference Design

The reference design, shown in the block diagram below, gives an example of how to use the PAN1780, to get a J-Link SWD and an FTDI UART connection on just one USB Port (X2).

The reference design of the evaluation board, including the provided peripherals is inspired by the design of the nRF52840 Development Kit from Nordic Semiconductors.

4.1 Block Diagram



The second available USB port (X5) on the evaluation board is directly connected to the D+ and the D- pins of the PAN1780. For schematics please refer to [⇒ 4.2 Schematic](#).

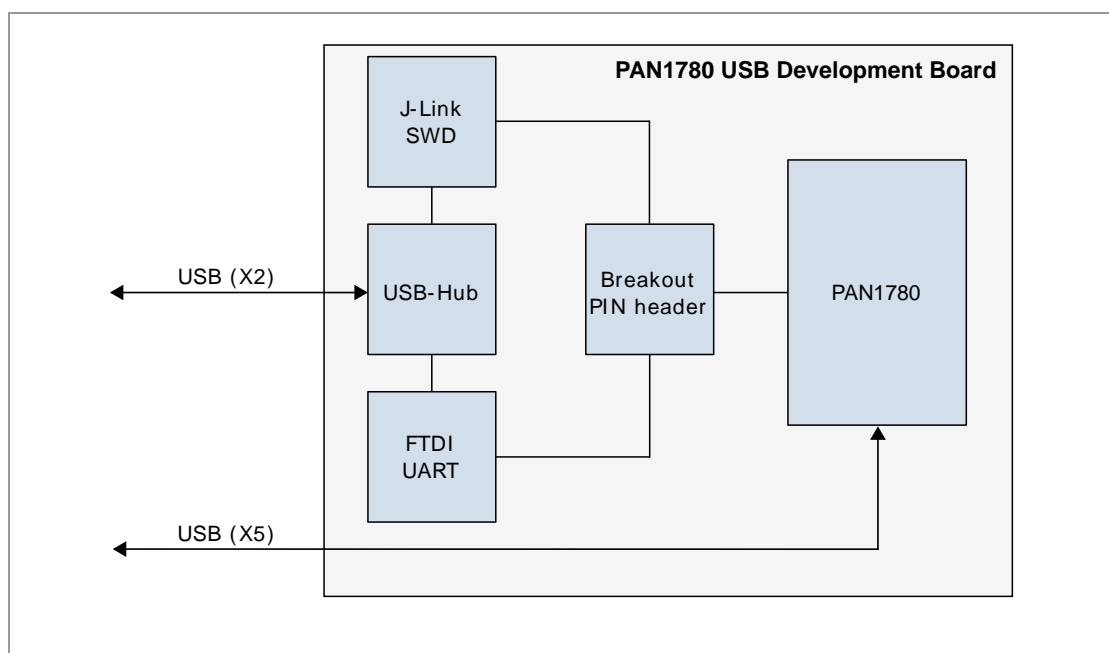

4.2 Schematic

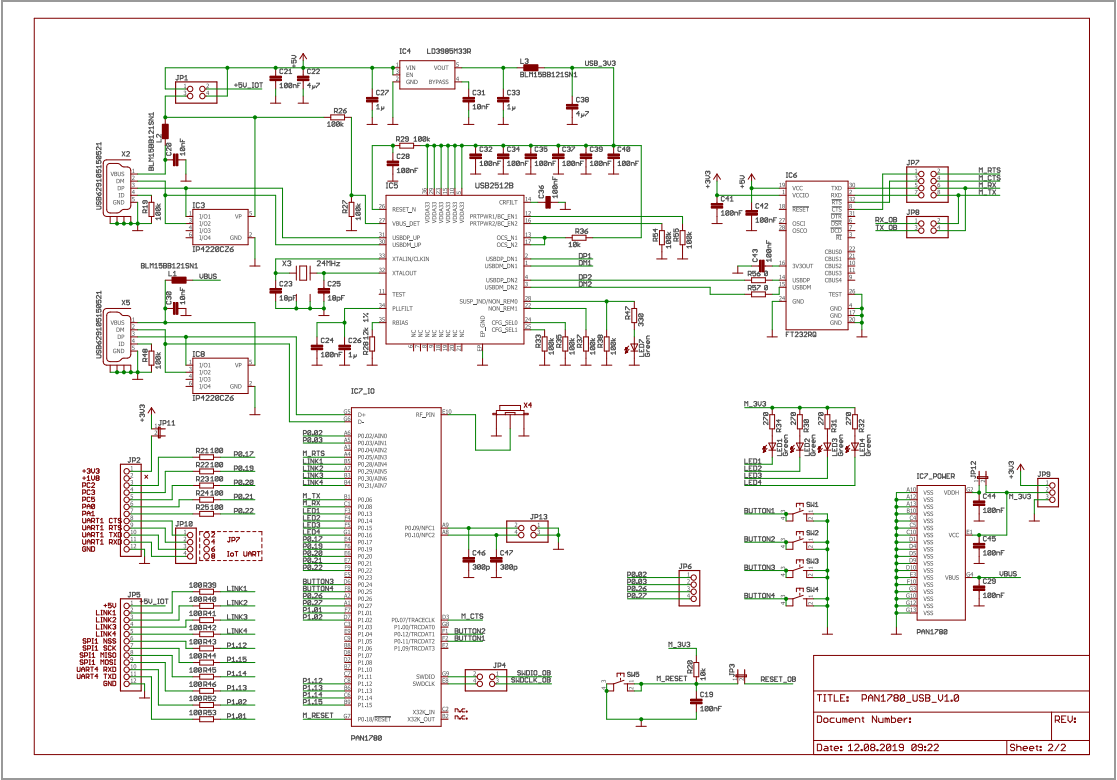
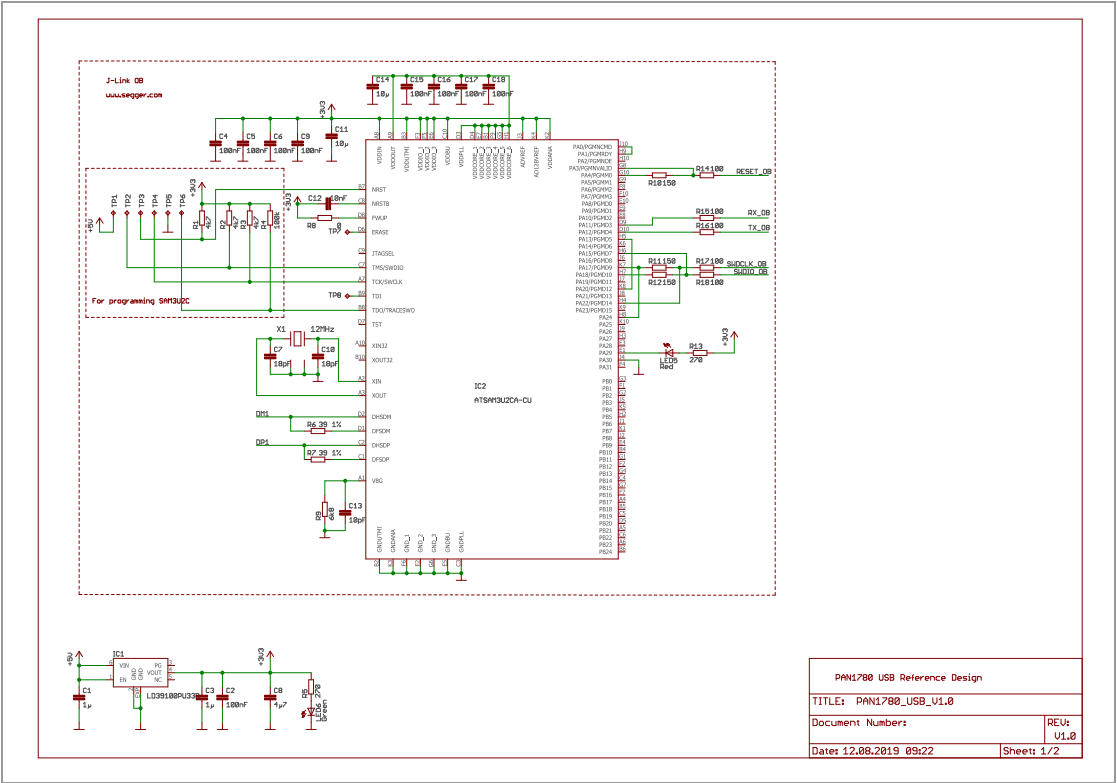

4.3 Building Blocks

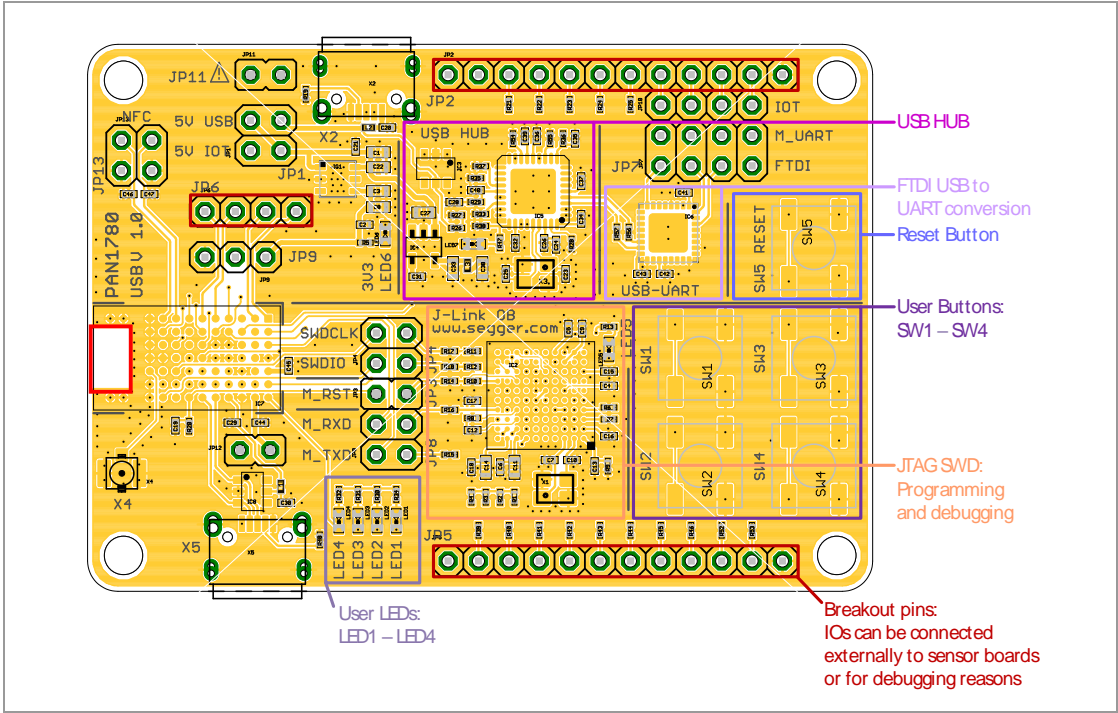

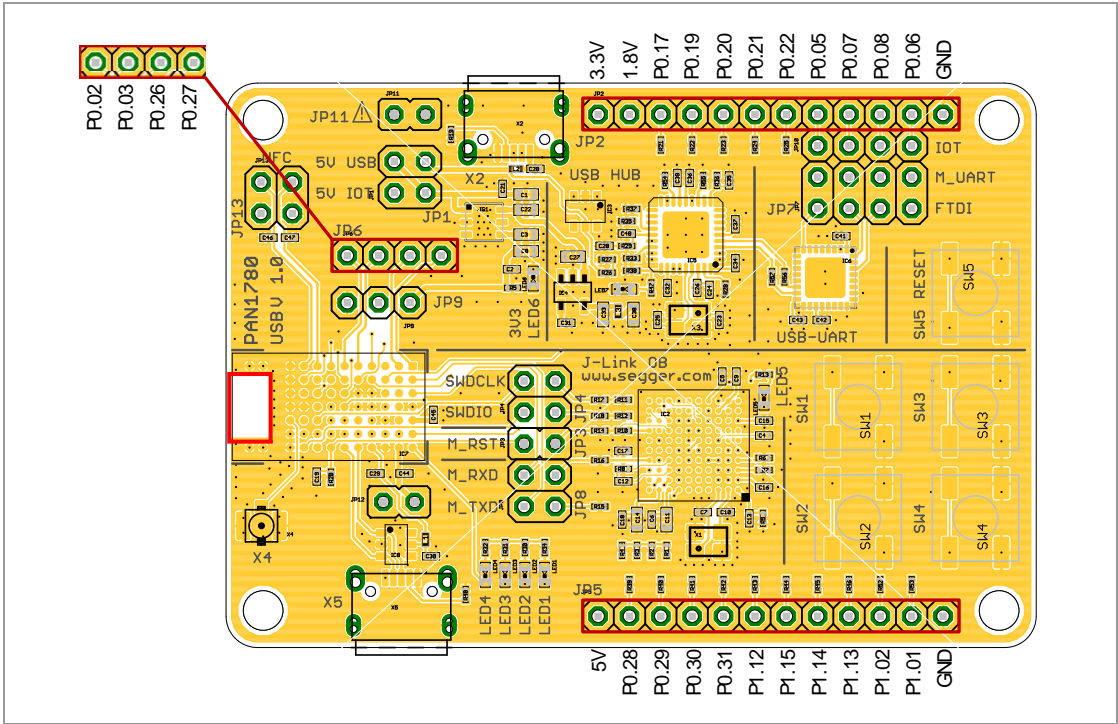

4.4 Breakout Pins



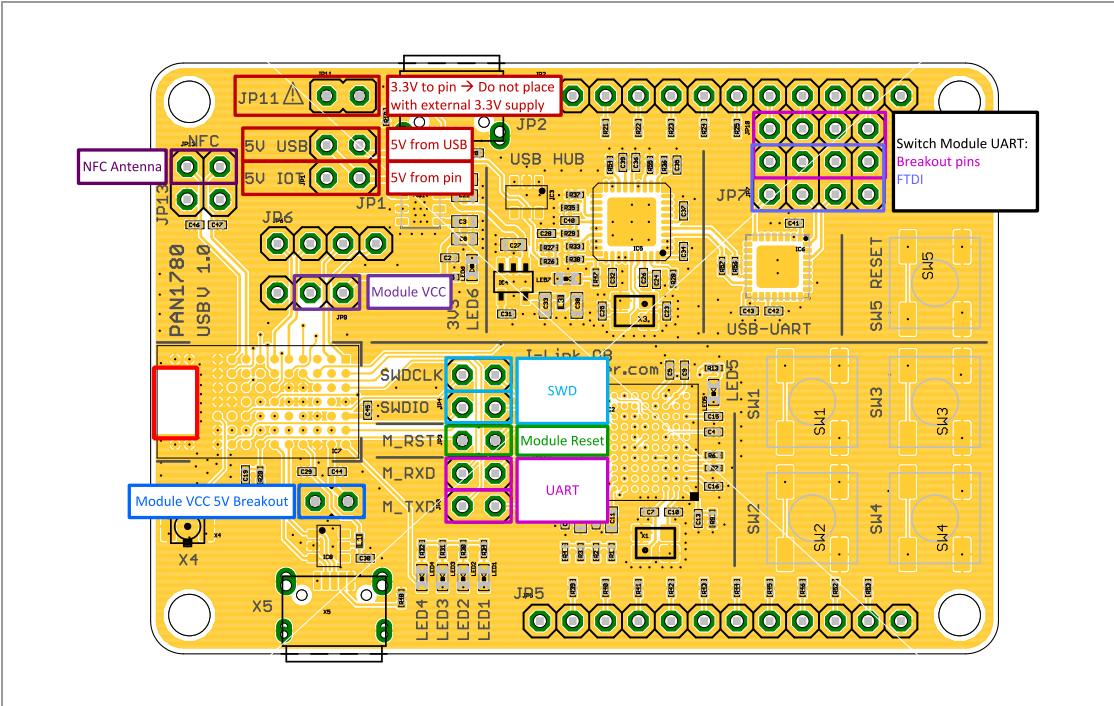











4.5 Configuration Settings

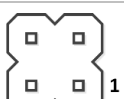
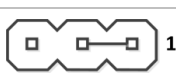
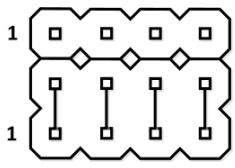
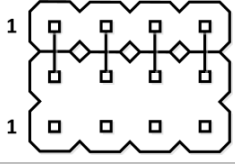

 **Jumper JP11**
Do not place JP11, if an external 3.3 V source is present.

 After each different configuration the reset button needs to be pressed.

Jumper	Layout	Description	
JP1	 1	5 V from USB connected	5 V power option, to power the board from USB or the 5 V pin. The 5 V from USB can also be used to power the sensor board.
	 1	5 V from or to breakout pin connected	

Jumper	Layout	Description	
JP3	 1	Module reset connected	
	 1	Module reset disconnected	
JP4	 1	SWD connected	Access to module and programmer SWD.
	 1	SWD disconnected	
JP8	 1	Module UART connected	Access to module UART Rx and Tx.
	 1	Module UART disconnected	
JP9	 1	Module V _{CC} connected	Module V _{CC} connection and GND pin. The module V _{CC} jumper can be removed for current measurements.
JP7, JP10	 1	FTDI connected to module UART	Option for module UART to breakout pin or FTDI. Place jumpers either just on JP7 or JP7 and JP10.
	 1	Breakout pins of JP2 connected to module UART	
JP11	 1	3.3 V are supplied to the breakout pin	Option to power an external sensor board with 3.3 V.
	 1	3.3 V are not supplied to the breakout pin	
JP12	 1	Module V _{CC} connected	Option to break 3.3 V supply via JP9 and connect 5 V supply to pin 1 of JP12 to power the module.
	 1	Module V _{CC} not connected	
JP13	 1, 2, 3, 4	1, 3: GND 2, 4: NFC Antenna	Option to connect NFC antenna to PAN1780 module.

4.6 NFC Antenna Placement

For applications that need an external NFC antenna connection an antenna is provided inside the Evaluation Tool Kit. Please connect the antenna to JP13 as shown.

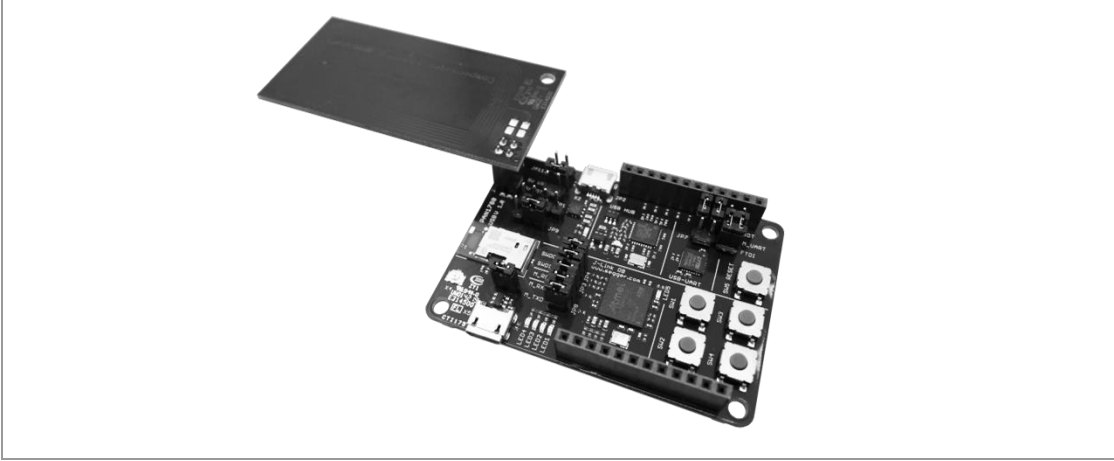

4.7 PCB Layout

4.7.1 Top Layer

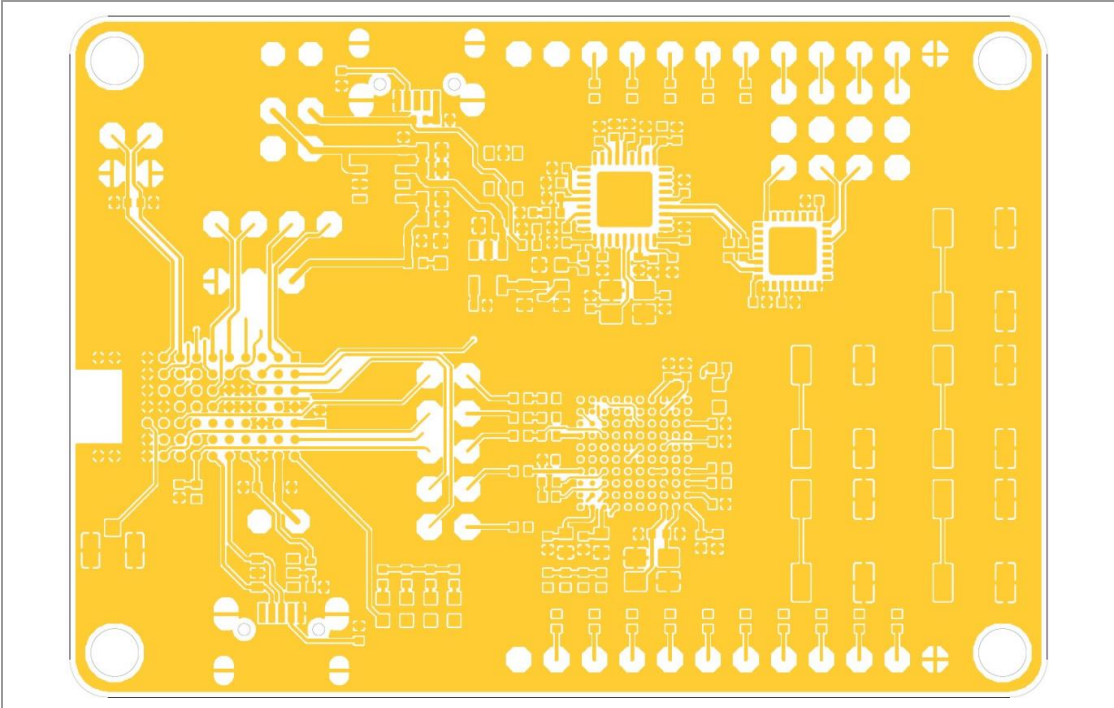

4.7.2 Second Layer

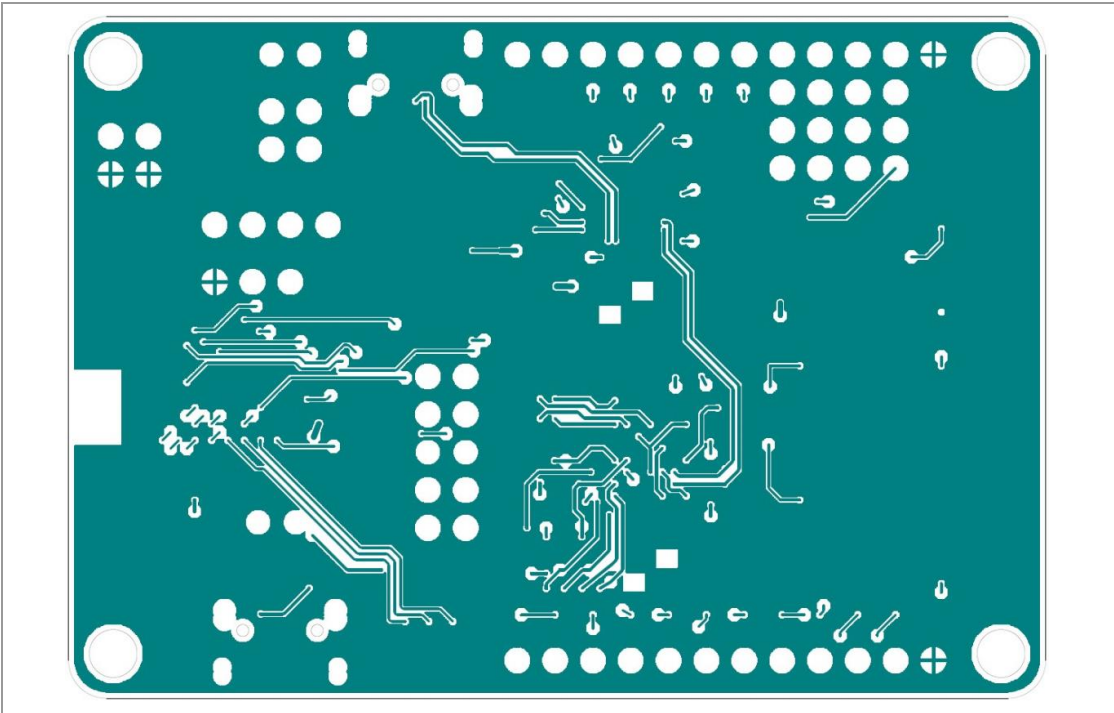

4.7.3 Third Layer

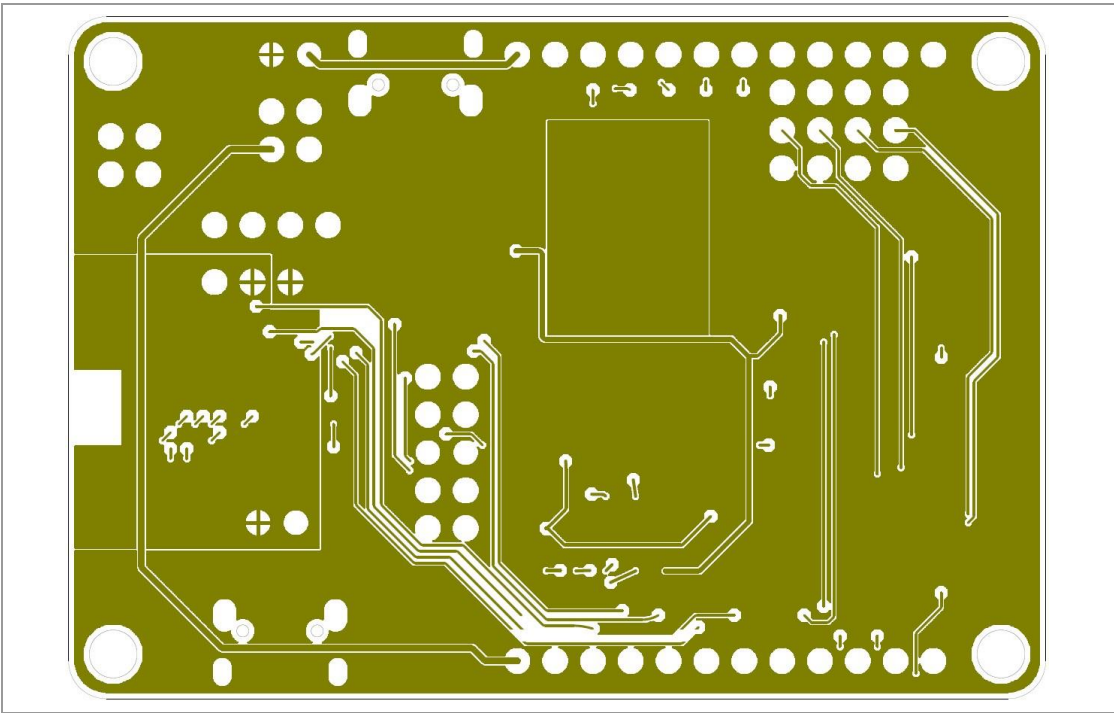

4.7.4 Bottom Layer

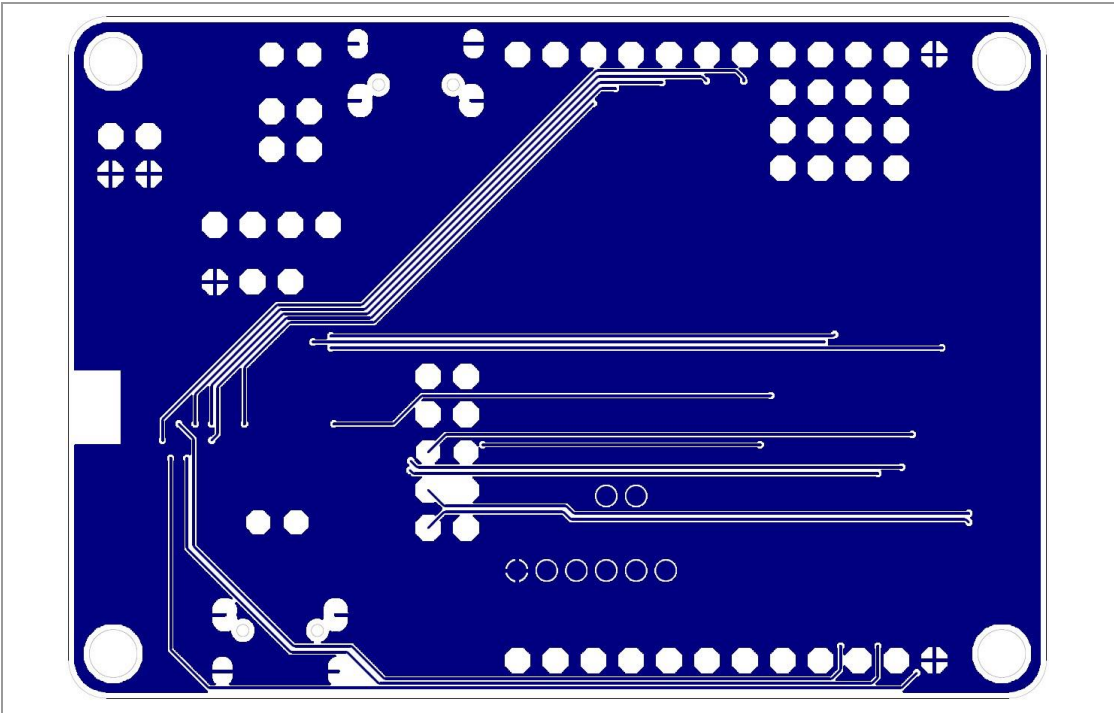

5 Getting Started

5.1 Default Jumper Configuration

- 1. Place all highlighted jumpers on PAN1780 ETU Evaluation Board.
- 2. Connect the device via USB (Socket X2) to power it.

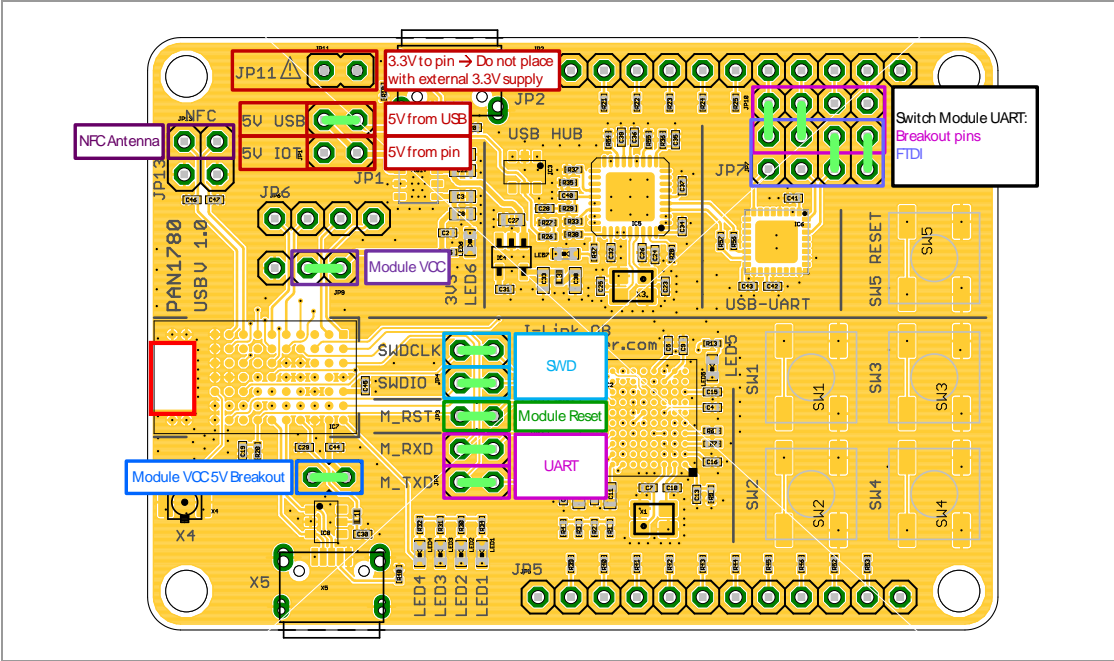

5.2 Device Drivers

5.2.1 General

It might be necessary to install drivers for some components.

Please note that the “FTDI USB UART” and the “Segger J-Link” SWD debugger provide COM ports to the system.

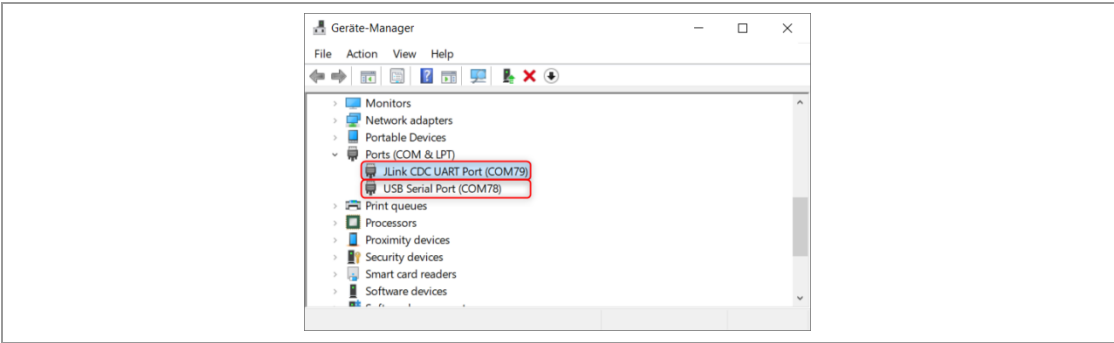



If the jumper configuration in ⇒ [5.1 Default Jumper Configuration](#) was considered, both COM ports can be used to open a UART connection to the PAN1780.

Another jumper configuration for JP4, JP7, and JP10 breaks the connection to the PAN1780, although they are available in the device manager view.

5.2.2 FTDI USB UART

Depending on the operating system that is used, drivers for the “FTDI USB UART” might not be installed automatically. If in doubt, please check the FTDI website and install the drivers manually.

For further information please visit <https://www.ftdichip.com/Drivers/VCP.htm>.

5.2.3 Segger J-Link SWD Debugger

Depending on the operating system that is used, drivers for “Segger J-Link” SWD debugger might not be installed automatically. If in doubt, please check the “Segger” website and install the drivers manually.

For further information please visit <https://www.segger.com/downloads/jlink/>.

5.3 Software Examples

The PAN1780 USB evaluation board is delivered without any preinstalled software examples, but the following chapters describe how to use the recommended development environment and the Nordic Semiconductors Software Development Kit (SDK) to run different kinds of software examples.

5.4 Getting Toolchain

5.4.1 Segger Embedded Studio

The Segger Embedded Studio is an integrated development environment (IDE) for developers, which is free to use for Nordic Semiconductor devices. Segger Embedded Studio comes with project management tools and supports ARM Cortex devices.

1. Visit the website <https://www.segger.com/>.
2. Click **Downloads** (1) and select **Embedded Studio** (2).

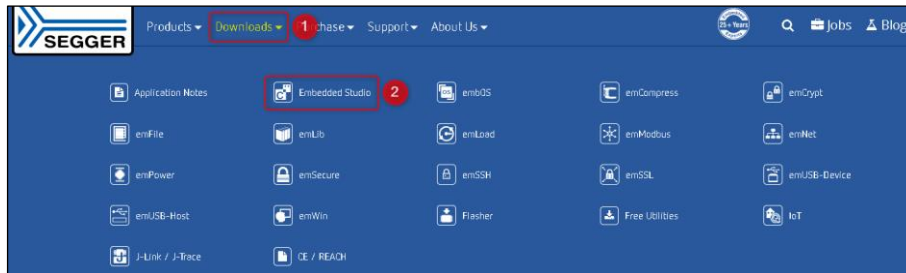

3. Select a preferred version and operating system and download it.

Embedded Studio for ARM				
	Version	Date	File size	
<input type="checkbox"/> Embedded Studio for ARM, Windows, 64-bit Simply download and run the installer.	V4.30b	[2019-11-19]	283,733 KB	<input type="button" value="DOWNLOAD"/>
<input type="checkbox"/> Embedded Studio for ARM, Windows, 32-bit Simply download and run the installer.	V4.30b	[2019-11-19]	264,377 KB	<input type="button" value="DOWNLOAD"/>
<input type="checkbox"/> Embedded Studio for ARM, macOS Download and mount the image, then run the installer.	V4.30b	[2019-11-19]	379,506 KB	<input type="button" value="DOWNLOAD"/>
<input type="checkbox"/> Embedded Studio for ARM, Linux, 64-bit Download and extract the archive, then run the installer.	V4.30b	[2019-11-19]	314,659 KB	<input type="button" value="DOWNLOAD"/>
<input type="checkbox"/> Embedded Studio for ARM, Linux, 32-bit Download and extract the archive, then run the installer.	V4.30b	[2019-11-19]	330,650 KB	<input type="button" value="DOWNLOAD"/>

4. Install **Segger Embedded Studio IDE** from the downloaded file.
 - ➔ After opening Segger Embedded Studio for the first time, it will show a manage license window.
5. Click **Activate Your Free License**, because Segger Embedded Studio will be used with a Nordic Semiconductor device.

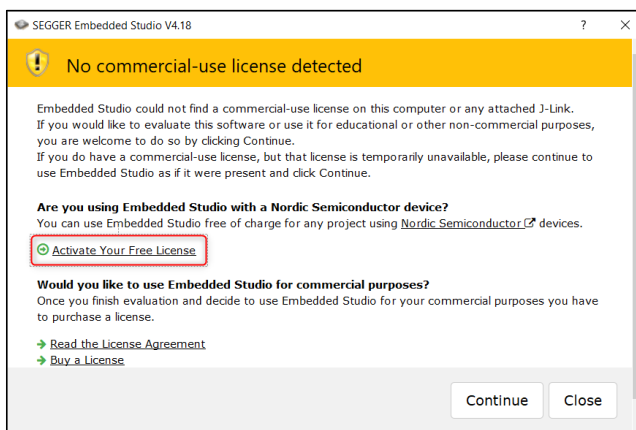

- ➔ Segger Embedded Studio will lead to the Embedded Studio License Activation.

6. Fill in the form and request the license.
7. The license key will be send to the mail address that has been given. Copy the License Activation Key from that mail.

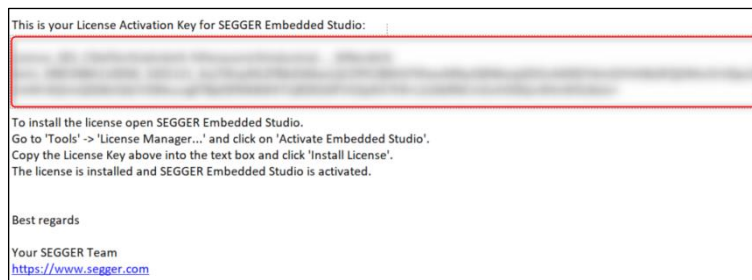

8. Open Segger Embedded Studio.
9. Click on the tab **Tools** (1) and select **Licence Manager...** (2).

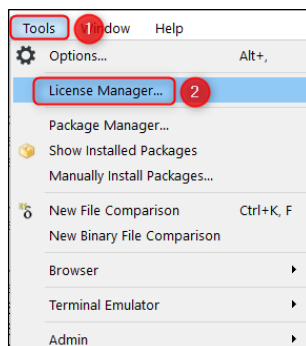

10. Click **Activate Embedded Studio**.

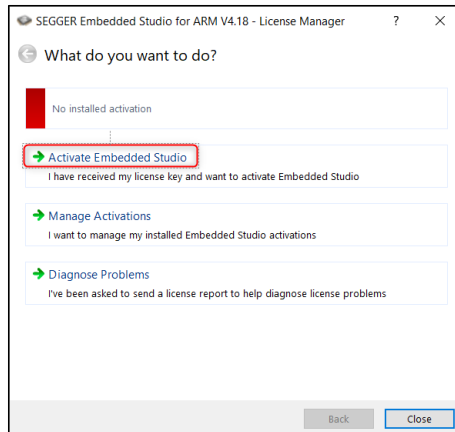

11. Enter the License Activation Key.

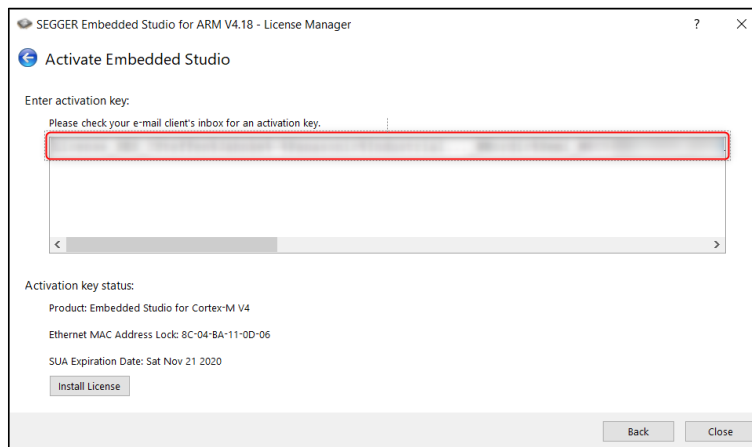

➔ Now the Segger Embedded Studio receives this non-commercial license to be used solely with Nordic Semiconductors devices.



A detailed guide, how to use Segger Embedded Studio, is available on YouTube. Search for “SEGGER Embedded Studio – Getting started”.



Other IDEs and tools that can be used with Nordic’s nRF5 SDK are Keil, IAR, and GCC. For detailed information please refer to Nordic Semiconductors infocenter infocenter.nordicsemi.com.

5.4.2 Nordic nRF Connect

1. Visit the website <https://www.nordicsemi.com/>.
2. Search for nRF Connect for Desktop: **Software and tools** (1) > **Development tools** (2) > **nRF Connect for Desktop** (3).

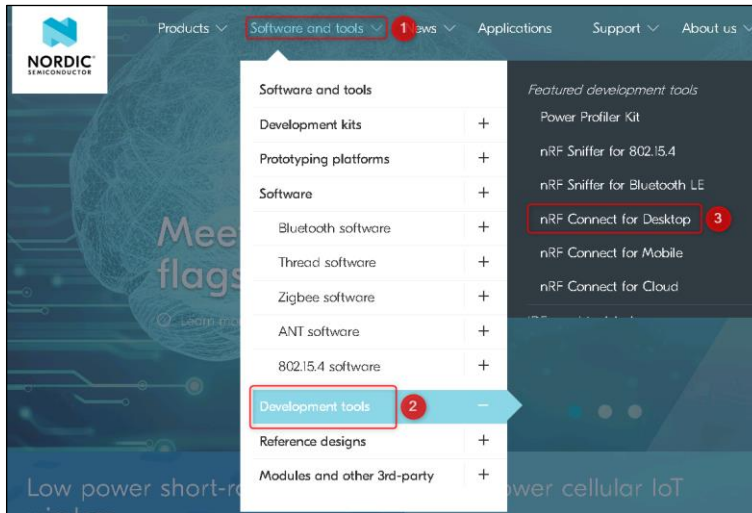

→ The download page will be shown.

3. Click on the tab **Downloads** (1) and click **Download file** (2).

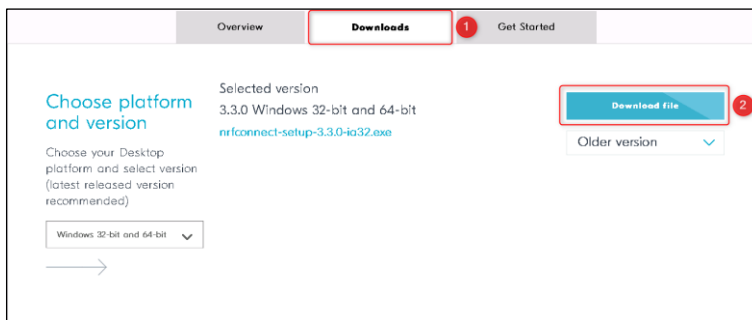

4. Install **nRF Connect** for Desktop.

5.4.3 Nordic SDK

1. Visit the website <https://www.nordicsemi.com/>.
2. Search for nRF5 SDK: **Software and tools (1) > Bluetooth software (2) > nRF5 SDK (3).**

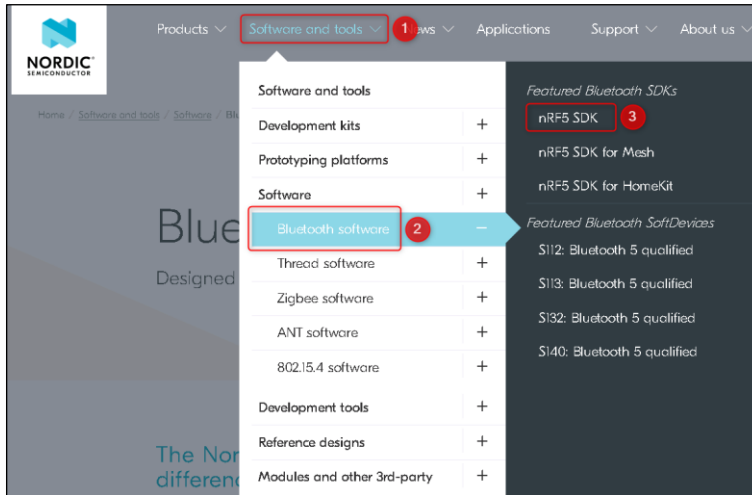

➔ The download page will be shown.

3. Click on the area **Download latest version, nRF5 SDK.**

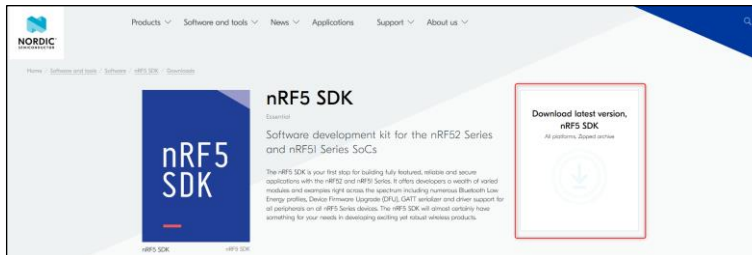

4. Extract the zipped SDK to a working directory.

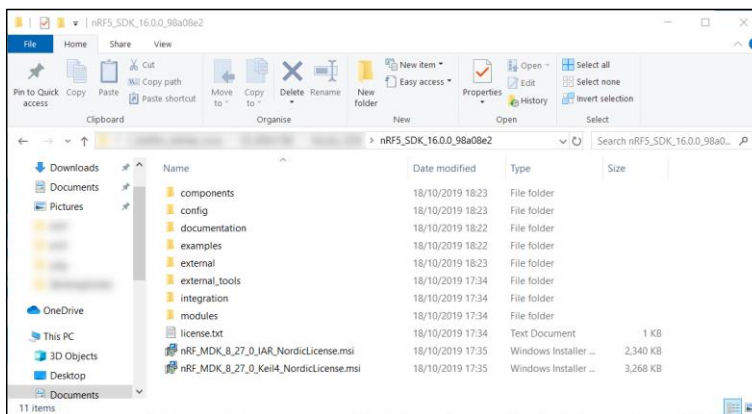

The extracted folder gives an overview about the nRF5 SDK.

For detailed information about hardware drivers, libraries, software examples, user guides, and data structures:

1. Open the folder `documentation`.
2. Open the file `index.html`.
 - ➔ The Nordic Semiconductor infocenter will give detailed information about the SDK.

Other Nordic SDKs

Other SDKs available for the PAN1780 are: **nRF SDK for Mesh** and **nRF SDK for Thread and Zigbee**. Downloads of this Nordic SDKs are available on Nordic Semiconductors website <https://www.nordicsemi.com>.

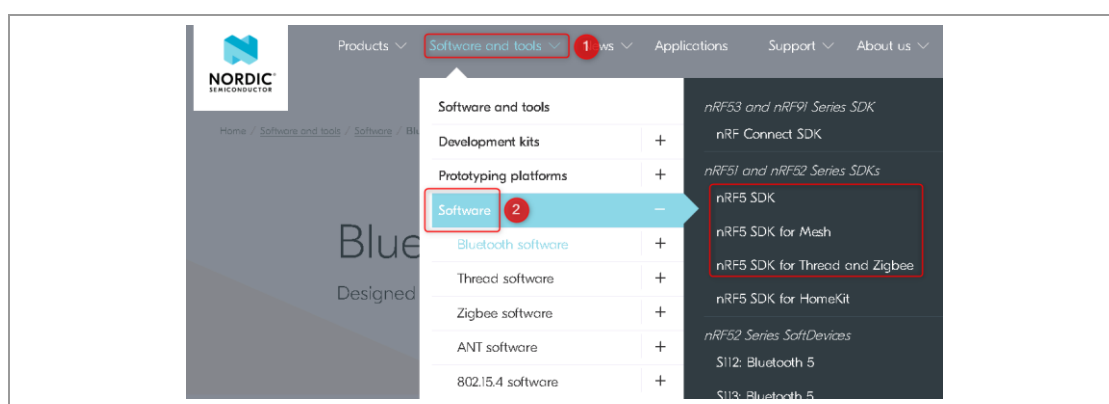

For detailed information about the SDK please visit Nordic Semiconductors infocenter <https://infocenter.nordicsemi.com>.

5.4.4 Mobile Apps

Nordic Semiconductors provides different mobile apps for Android™ devices in Google Play Store and iOS devices in Apple® App Store. The following overview shows briefly the purpose of these apps, recommended for using with PAN1780 ETU.

App	Description
nRF Connect	App that allows, to scan for Bluetooth devices and communicate with them.
nRF Toolbox	Container app for the most popular Bluetooth accessories, also including Device Firmware Update (DFU) over-the-air (OTA).
nRF Blinky	Simple app to give a good starting point for app development
nRF UART	Bluetooth app for UART service

For an exemplary use of the nRF Blinky mobile app with PAN1780 please refer to ⇒ 5.5.3 nRF Blinky Mobile App or visit Nordic Semiconductors website <https://www.nordicsemi.com/>.

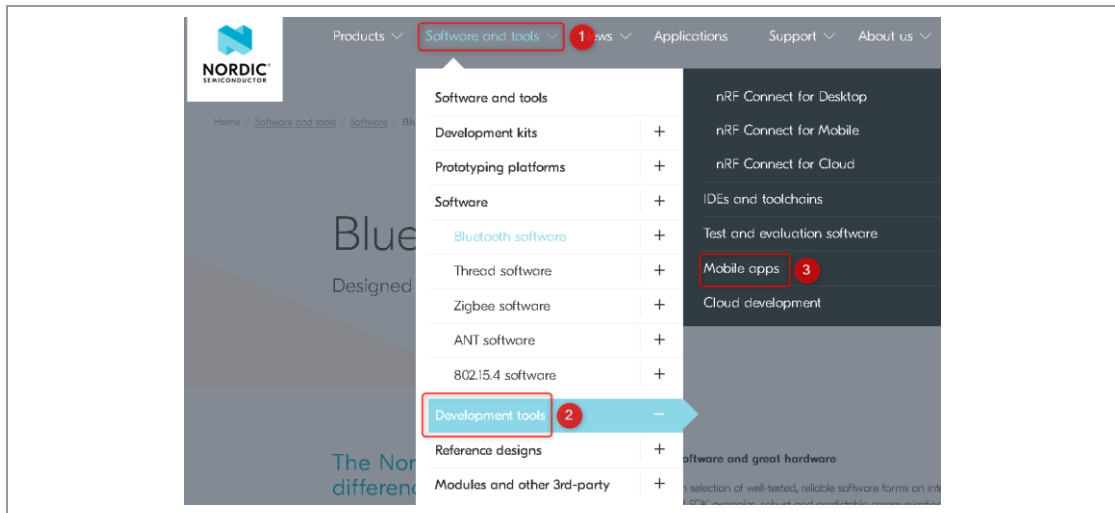

5.5 Getting Started

This chapter gives an overview about the basic usage of the previously downloaded and installed tools, needed for using examples from SDK in first step and development of own software in next step.

5.5.1 nRF Connect for Desktop

The following description shows how to flash a precompiled example *.hex-file from Nordics nRF5 SDK with **nRF Connect for Desktop**.

The following requirements must be met:

- ✓ nRF Connect for Desktop is installed on PC.
- ✓ The PAN1780 evaluation board is connected via USB cable on USB port X2 to the PC.

1. Open **nRF Connect for Desktop**.
2. Click **Open** to use the programmer module.

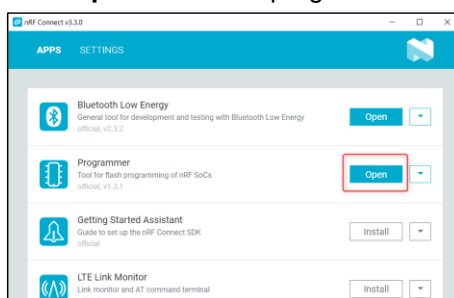

3. Select the preferred device in the drop down menu (1). For Segger ID please see on bottom of the PAN1780 ETU.

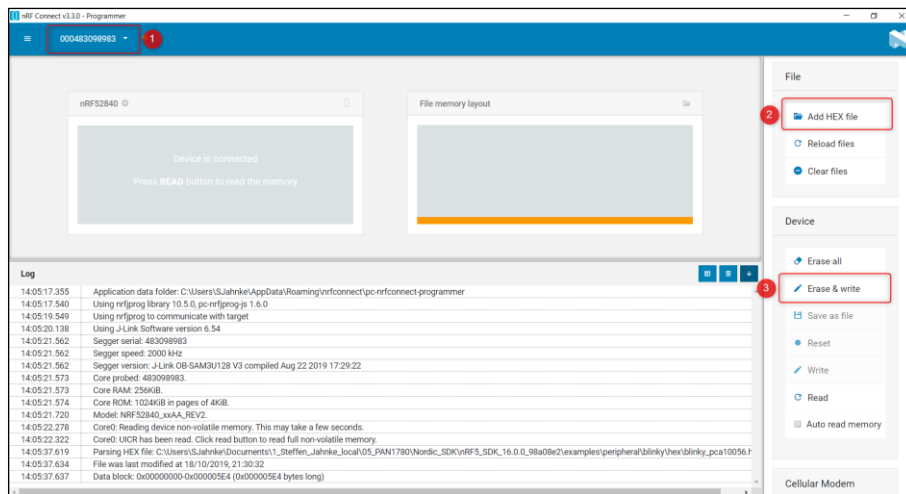

4. Click **Add HEX file** (2).
5. Add the example .hex-file from Nordic SDK folder **nRF5_SDK_16.0.0_98a08e2 > examples > peripheral > blinky > hex** (2) with the designation **blinky_pca10056.hex**.
6. After the .hex-file was loaded successfully in nRF Connect, click **Erase & write** (3).
 - ➔ Now the blinky application will be flashed on the PAN1780 ETU. The LEDs LED1, LED2, LED3, and LED4 will start to blink.

5.5.2 Segger Embedded Studio

The following description shows how to start developing with PAN1780 and Segger Embedded Studio.

1. Open Segger Embedded Studio IDE.
2. Click **File** and select **Open Solution...**

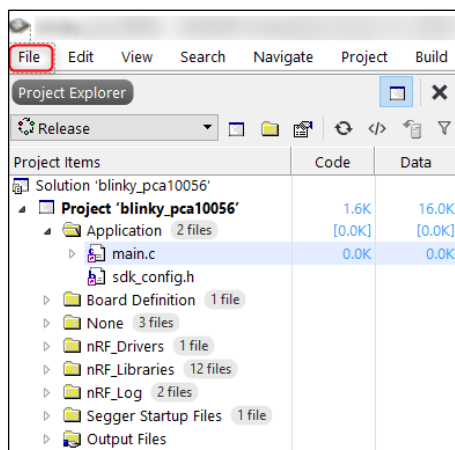

3. Open the solution **blinky_pca10056.emProject** in the Nordic SDK folder **nRF5_SDK_16.0.0_98a08e2 > examples > peripheral > blinky > pca10056 > blank > ses**.

4. Open the file **main.c** (1).

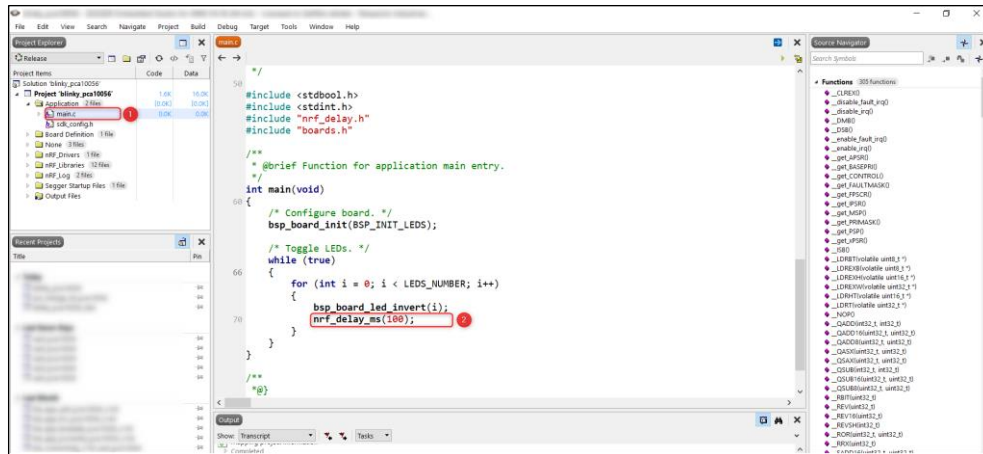

5. Change the code in line 70 “nrf_delay_ms(500)” to “nrf_delay_ms(100)” (2) and press **F5**.

6. After flashing the software example press the button start  in IDE.

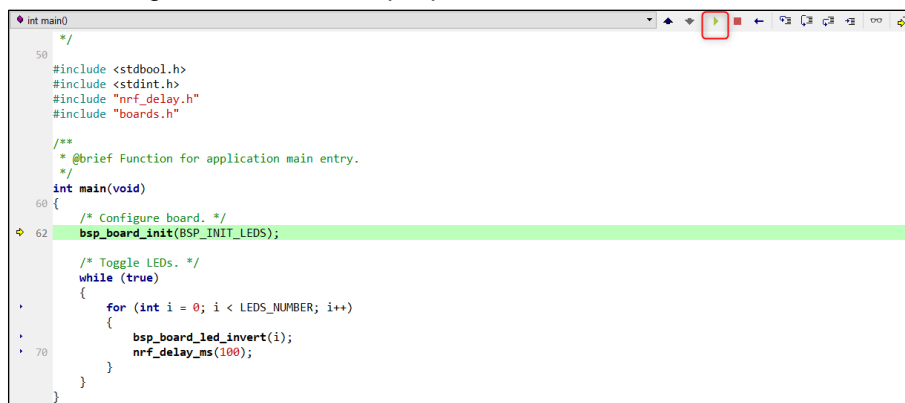

➔ The blinky application will start. The LEDs LED1, LED2, LED3, and LED4 will start to blink much faster than in previous example from .hex-file (⇒ 5.5.1 nRF Connect for Desktop).

5.5.3 nRF Blinky Mobile App

The following requirements must be met:

- ✓ PAN1780 ETU is powered via USB connector X2.
- ✓ Nordic Semiconductors app **nRF Blinky** from Apple App Store or Google Play Store is installed.
- ✓ The application **ble_app_blinky_pca10056_s140.hex** from SDK folder **nRF5_SDK_16.0.0_98a08e2 > examples > ble_peripheral > ble_app_blinky > hex** is flashed to PAN1780 device ⇒ 5.4.2 Nordic nRF Connect.



If the app **nRF Blinky** is running on PAN1780, LED1 is solid ON.

1. Open the mobile app **nRF Blinky**.
2. Connect to the device **Nordic_Blinky**.

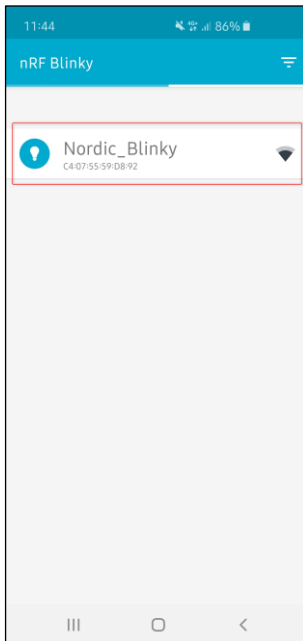

→ LED1 will switch OFF and LED2 will be solid ON now.

Now the mobile app **nRF Blinky** can be used for demonstrating communication.

1. Click on the slider (1) to toggle the LED3 on PAN1780 ETU.

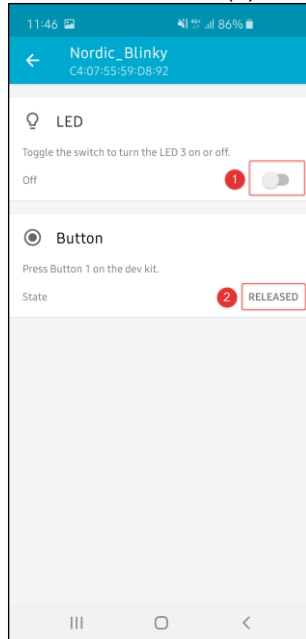

2. The button “SW1” on PAN1780 can be pressed, to send status of the button to the mobile app (2).

In parallel a terminal can be used, to get information about the current status from module via UART:

1. Connect the PAN1780 on USB port X2 to the PC.
2. Open the COM port of PAN1780 with the following configuration:
 - Baud 115200
 - Data 8
 - Parity N
 - Stop 1

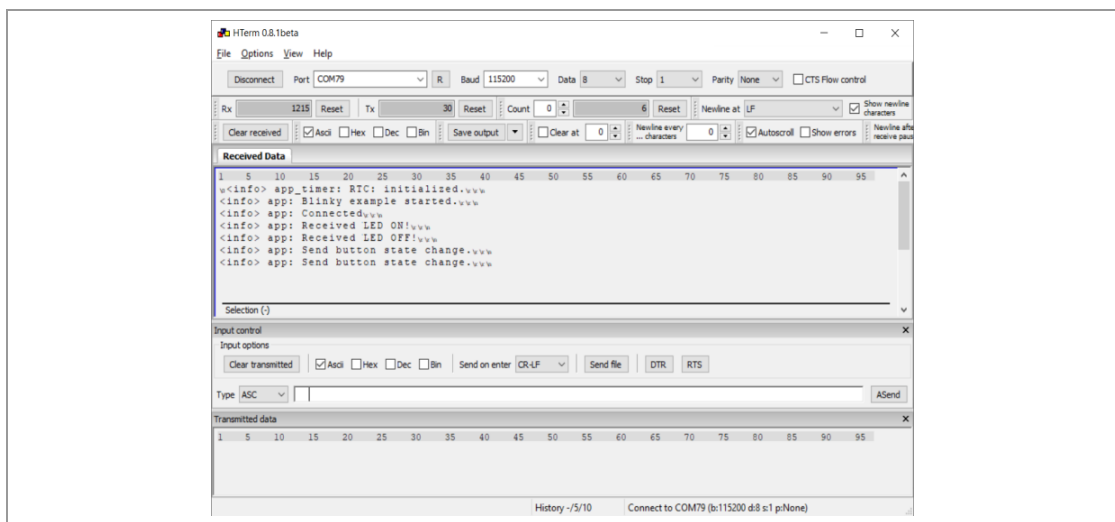

6 Regulatory and Certification Information

6.1 General Certification Information



Regulatory certifications are valid for the following radio relevant software:

- Nordic Soft Device S140 or S113
- Bluetooth Specification 5



For further certification requests for other radio software please contact Panasonic ⇒ [8 Contact Details](#).

6.2 Federal Communications Commission (FCC) for US

6.2.1 FCC Statement

The following FCC statement has to be printed in the OEM end product user information:

The device meets the requirements for modular transmitter approval as detailed in FCC public Notice DA00-1407. The transmitter operation is subject to the following two conditions:

1. This device may not cause harmful interference, and
2. This device must accept any interference received, including interference that may cause undesired operation.

6.2.2 Caution

The following FCC caution has to be printed in the OEM end product user information:



The FCC requires the user to be notified that any changes or modifications made to this device that are not expressly approved by Panasonic Industrial Devices Europe GmbH may void the user's authority to operate the equipment.



This equipment has been tested and found to comply with the limits for a Class B digital device, pursuant to Part 15 of the FCC Rules.

These limits are designed to provide reasonable protection against harmful interference in a residential installation. This equipment generates uses and can radiate radio frequency energy and, if not installed and used in accordance with the instructions, may cause harmful interference to radio communications.

However, there is no guarantee that interference will not occur in a particular installation. If this equipment does cause harmful interference to radio or television reception (which can be determined by turning the equipment off and on) the user is encouraged to try to correct the interference by one or more of the following measures:

- Reorient or relocate the receiving antenna,
- Increase the separation between the equipment and receiver,
- Connect the equipment into an outlet on a circuit different from that to which the receiver is connected,
- Consult the dealer or an experienced radio/TV technician for help.

6.2.3 Label Requirements

The following labelling requirements have to be implemented on the OEM end product:



The OEM must ensure that FCC labelling requirements are met. This includes a clearly visible label on the outside of the OEM enclosure specifying the appropriate Panasonic FCC identifier for this product as well as the FCC notice above.

The FCC identifier is **FCC ID: T7V1780**.

This FCC identifier is valid for the PAN1780.
The end product must in any case be labelled on the exterior with:

"Contains FCC ID: T7V1780"

Due to the PAN1780 model size, the FCC identifier is displayed in the installation instruction only and it cannot be displayed readable on the module's label due to the limited size.

6.2.4 Antenna Warning

The following Antenna has to be followed by the OEM:

This antenna warning refers to the device with the model number PAN1780.

The device is tested with a integrated antenna listed below. When integrated into the OEM's product, these fixed antennas require installation preventing end users from replacing them with non-approved antennas. Any antenna not in the following table must be tested to comply with FCC Section 15.203 for unique antenna connectors and with Section 15.247 for emissions.

6.2.5 Approved Antenna List

Item	Part Number	Manufacturer	Frequency Band	Type	Max. Gain (dBi)
1	ANT016008LCS2442MA1	TDK	2.4 GHz	Chip Antenna	-1.0

6.2.6 RF Exposure



To comply with FCC RF Exposure requirements, the OEM must ensure that only antennas from the Approved Antenna List are installed ⇒ [6.2.5 Approved Antenna List](#).

The preceding statement must be included as a “CAUTION” statement in manuals for products operating with the approved antennas to alert users on FCC RF Exposure compliance.

Any notification to the end user of installation or removal instructions about the integrated radio module is not allowed.

The radiated output power of the PAN1780 with a mounted ceramic antenna (**FCC ID: T7V1780**) is below the FCC radio frequency exposure limits. Nevertheless, the PAN1780 shall be used in such a manner that the potential for human contact during normal operation is minimized.

End users may not be provided with the module installation instructions. OEM integrators and end users must be provided with transmitter operating conditions for satisfying RF exposure compliance.

6.3 Innovation, Science, and Economic Development (ISED) for Canada

The following IC rules have to be followed by end product OEM's:

English

The PAN1780 is licensed to meet the regulatory requirements of ISED.

License ID: **IC: 216Q-1780**
HVIN: **ENW89854A1KF**

Manufacturers of mobile, fixed or portable devices incorporating this module are advised to clarify any regulatory questions and ensure compliance for SAR and/or RF exposure limits. Users can obtain Canadian information on RF exposure and compliance from www.ic.gc.ca.

This device has been designed to operate with the antennas listed in Approved Antenna List, having a maximum gain of -1.0 dBi. Antennas not included in this list or having a gain greater than -1.0 dBi are strictly prohibited for use with this device. The required antenna impedance is 50 ohms. The antenna used for this transmitter must not be co-located or operating in conjunction with any other antenna or transmitter without the need of re-assessment of conformity by ISED.

Due to the model size, the IC identifier is displayed in the installation instruction and on the package label only. It cannot be displayed readable on the module's label due to the limited size.



The end customer has to assure that the device has a distance of more than 15 mm from the human body under all circumstances.

If the end customer application intends to use the PAN1780 in a distance smaller 15 mm from the human body, SAR evaluation has to be repeated by the OEM.

The end customer equipment must meet the actual Safety/Health requirements according to ISED.

French

PAN1780 est garanti conforme aux dispositions réglementaires d'Industry Canada (ISED).

License: **IC: 216Q-1780**

HVIN: **ENW89854A1KF**

Il est recommandé aux fabricants d'appareils fixes, mobiles ou portables de consulter la réglementation en vigueur et de vérifier la conformité de leurs produits relativement aux limites d'exposition aux rayonnements radiofréquence ainsi qu'au débit d'absorption spécifique maximum autorisé.

Des informations pour les utilisateurs sur la réglementation Canadienne concernant l'exposition aux rayonnements RF sont disponibles sur le site www.ic.gc.ca.

Ce produit a été développé pour fonctionner spécifiquement avec les antennes listées dans le tableau Approved Antenna List, présentant un gain maximum de -1.0 dBi. Des antennes autres que celles listées ici, ou présentant un gain supérieur à -1.0 dBi ne doivent en aucune circonstance être utilisées en combinaison avec ce produit. L'impédance des antennes compatibles est 50 Ohm. L'antenne utilisée avec ce produit ne doit ni être située à proximité d'une autre antenne ou d'un autre émetteur, ni être utilisée conjointement avec une autre antenne ou un autre émetteur.

En raison de la taille du produit, l'identifiant IC est fourni dans le manuel d'installation.



Le client final doit s'assurer que l'appareil se trouve en toutes circonstances à une distance de plus de 15 mm du corps humain.

Si le client final envisage une application nécessitant d'utiliser le PAN1780 à une distance inférieure à 15 mm du corps humain, alors le FEO doit répéter l'évaluation DAS.

L'équipement du client final doit répondre aux exigences actuelles de sécurité et de santé selon l'ISED.

6.3.1 IC Notice

The following IC notice has to be printed in English and French in the OEM end product user information:

English



The device PAN1780, including the integrated antenna mentioned in ⇒ [6.2.5 Approved Antenna List](#), complies with Canada RSS-GEN Rules. The device meets the requirements for modular transmitter approval as detailed in RSS-Gen.

Operation is subject to the following two conditions:

1. This device may not cause harmful interference, and
2. This device must accept any interference received, including interference that may cause undesired operation.

French



Le présent appareil PAN1780, les antennes y compris ⇒ [6.2.5 Approved Antenna List](#) est conforme aux CNR-Gen d'Industrie Canada applicables aux appareils radio exempts de licence.

L'exploitation est autorisée aux deux conditions suivantes:

1. L'appareil ne doit pas produire de brouillage, et
2. L'utilisateur de l'appareil doit accepter tout brouillage radioélectrique subi, même si le brouillage est susceptible d'en compromettre le fonctionnement.

6.3.2 Labeling Requirements

The following IC labelling requirements have to be followed by end product OEM's:

English



Labeling Requirements

The OEM must ensure that IC labelling requirements are met. This includes a clearly visible label on the outside of the OEM enclosure specifying the appropriate Panasonic IC identifier for this product as well as the IC Notice above.

The IC identifier is: **IC: 216Q-1780**

This IC identifier is valid for the PAN1780 module. In any case, the end product must be labelled on the exterior with:

"Contains IC: 216Q-1780"

French



Obligations d'étiquetage

Les fabricants d'équipements d'origine (FEO) – en anglais Original Equipment Manufacturer (OEM) – doivent s'assurer que les obligations d'étiquetage IC du produit final sont remplies. Ces obligations incluent une étiquette clairement visible à l'extérieur de l'emballage externe, comportant l'identifiant IC du module Panasonic inclus, ainsi que la notification ci-dessus.

L' identifiant IC est: **IC: 216Q-1780**

Cet identifiant est valide pour module PAN1780. Dans tous les cas les produits finaux doivent indiquer sur leur emballage externe la mention suivante:

"Contient IC: 216Q-1780"

6.4 European Conformity According to RED (2014/53/EU)



All modules described in this Module Integration Guide comply with the standards according to the following LVD (2014/35/EU), EMC-D (2014/30/EU) together with RED (2014/53/EU) articles.

Standards

- Due to the model size, the CE marking is displayed in the installation instruction and on the package label only. It cannot be displayed according to regulation (EU) No. 765/2008 in 5 mm height on the module's label due to the limited space.
- The end product OEM has to re-assess the conformity of the end product to EU regulations, but can use the PAN1780 RED pre-assessment to shorten this procedure.
- The RED EU Type Examination Certificate No. **T818666M-01** issued by the Notified Body 0682 can be used for the OEM end product conformance assessment. If a Notified Body has been contracted for the end product conformity assessment, it should be noted that this EU Type Examination Certificate should be used for conformance assessment.

As a result of the OEM end product conformity assessment procedure described in 2014/53/EU Directive and other applicable EU directives, the end customer equipment should be labelled as follows:



The requirements for CE marking are described in regulation (EU) No. 765/2008 Annex II.



The end customer has to assure that the device has a distance of more than 5 mm from the human body under all circumstances.

If the end customer application intends to use the PAN1780 in a distance smaller 5 mm from the human body, SAR evaluation has to be repeated by the OEM.

The end customer equipment must meet the actual Safety/Health requirements according to RED.

PAN1780 and its model versions in the specified reference design can be used in all countries of the European Economic Area (Member States of the EU, European Free Trade Association States [Iceland, Liechtenstein, Norway]), Monaco, San Marino, Andorra, and Turkey.

6.5 Bluetooth

For Bluetooth end products which integrate the PAN1780 the OEM needs to apply for an own end product listing (EPL) at the Bluetooth SIG. If the PAN1780 is used on more than one OEM product, costs can be saved by applying for a family EPL.

For the end product EPL the following IDs can be used in order to avoid re-testing:

Bluetooth 5	Declaration ID	QDID
End product	D050150	148922

Bluetooth Marks

According to the Bluetooth SIG, the PAN1780 fulfills the criteria to label your product as a Bluetooth device:



For further information please refer to the Bluetooth website www.bluetooth.com

7 Restricted Use

7.1 Life Support Policy

This Panasonic Industrial Devices Europe GmbH product is not designed for use in life support appliances, devices, or systems where malfunction can reasonably be expected to result in a significant personal injury to the user, or as a critical component in any life support device or system whose failure to perform can be reasonably expected to cause the failure of the life support device or system, or to affect its safety or effectiveness.

Panasonic customers using or selling these products for use in such applications do so at their own risk and agree to fully indemnify Panasonic Industrial Devices Europe GmbH for any damages resulting.

7.2 Restricted End Use

This Panasonic Industrial Devices Europe GmbH product is not designed for any restricted activity that supports the development, production, handling usage, maintenance, storage, inventory or proliferation of any weapons or military use.

Transfer, export, re-export, usage or reselling of this product to any destination, end-user or any end-use prohibited by the European Union, United States or any other applicable law is strictly prohibited.

8 Contact Details

8.1 Contact Us

Please contact your local Panasonic Sales office for details on additional product options and services:

For Panasonic Sales assistance in the **EU**, visit

<https://eu.industrial.panasonic.com/about-us/contact-us>

Email: wireless@eu.panasonic.com

For Panasonic Sales assistance in **North America**, visit the Panasonic website “Sales & Support” to find assistance near you at

<https://na.industrial.panasonic.com/distributors>

Please visit the **Panasonic Wireless Technical Forum** to submit a question at

<https://forum.na.industrial.panasonic.com>

8.2 Product Information

Please refer to the Panasonic Wireless Connectivity website for further information on our products and related documents:

For complete Panasonic product details in the **EU**, visit

<http://pideu.panasonic.de/products/wireless-modules.html>

For complete Panasonic product details in **North America**, visit

<http://www.panasonic.com/rfmodules>