



To Be Discontinued
Last time buy: September 30, 2021

**TV-5/TV-8 rated
1 Form A 5A/8A silent type
power relays**

LK-Q RELAYS

Protective construction : Flux-resistant type

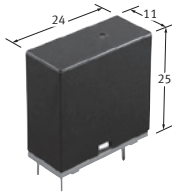

(Unit : mm)

FEATURES

- 1. High sensitivity**
A nominal operating power of 250mW and high sensitivity make it ideal for energy saving (LK relay is 530mW).
- 2. Silent**
Approx. 10 dB less sound pressure than previous LK series relay
- 3. High inrush current capability**
Switching capability;
• TV-5 type: inrush 100A, steady: 5A
• TV-8 type: inrush 118A, steady: 8A
- 4. Long insulation distance**
1) Creepage distance and clearances between contact and coil: Min. 6 mm .236 inch (In compliance with IEC60065)
2) Surge withstand voltage between contact and coil: 10,000 V

- 5. Conforms to the various safety standards**
UL/C-UL, TÜV, and SEMKO approved

TYPICAL APPLICATIONS

- Flat-panel TVs
- Audio visual equipment

ORDERING INFORMATION

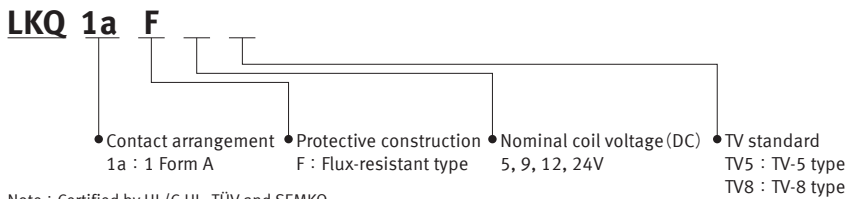

Note : Certified by UL/C-UL, TÜV and SEMKO

TYPES

Contact arrangement	Nominal coil voltage	Part No.	
		TV-5 type	TV-8 type
1 Form A	5V DC	LKQ1aF-5V-TV5	LKQ1aF-5V-TV8
	9V DC	LKQ1aF-9V-TV5	LKQ1aF-9V-TV8
	12V DC	LKQ1aF-12V-TV5	LKQ1aF-12V-TV8
	24V DC	LKQ1aF-24V-TV5	LKQ1aF-24V-TV8

Standard packing: Carton: 100 pcs.; Case: 500 pcs.

RATING

1. Coil data

- Operating characteristics such as 'Operate voltage' and 'Release voltage' are influenced by mounting conditions, ambient temperature, etc. Therefore, please use the relay within $\pm 5\%$ of rated coil voltage.
- 'Initial' means the condition of products at the time of delivery.

Nominal coil voltage	Pick-up voltage (at 20°C 68°F)	Drop-out voltage (at 20°C 68°F)	Nominal operating current [$\pm 10\%$] (at 20°C 68°F)	Coil resistance [$\pm 10\%$] (at 20°C 68°F)	Nominal operating power	Max. applied voltage (at 20°C 68°F)
5V DC	80%V or less of nominal voltage (Initial)	10%V or more of nominal voltage (Initial)	50 mA	100Ω	250mW	6.5V DC
9V DC			27.8mA	324Ω		11.7V DC
12V DC			20.8mA	576Ω		15.6V DC
24V DC			10.4mA	2,304Ω		31.2V DC

2. Specifications

Characteristics	Item	Specifications	
		TV-5 type	TV-8 type
Contact	Arrangement	1 Form A	
	Contact resistance (Initial)	Max. 100mΩ (By voltage drop 6 V DC 1A)	
	Contact material	AgSnO ₂ type	
Rating	Nominal switching capacity (resistive load)	5A 277V AC	8A 277V AC
	Max. switching power (resistive load)	1,385VA	2,216VA
	Max. switching voltage	277V AC	
	Max. switching current	5A (AC)	8A (AC)
	Min. switching capacity (reference value)*1	100mA, 5V DC	
Electrical characteristics	Insulation resistance (Initial)	Min. 1,000MΩ (at 500V DC) Measurement at same location as "Breakdown voltage" section.	
	Breakdown voltage (Initial)	Between open contacts	1,000 Vrms for 1 min. (Detection current: 10 mA)
		Between contact and coil	4,000 Vrms for 1 min. (Detection current: 10 mA)
	Surge breakdown voltage*2 (Between contact and coil) (Initial)	10,000 V	
	Operate time (at nominal voltage) (at 20°C 68°F) (Initial)	Max. 15 ms (excluding contact bounce time.)	
Release time (at nominal voltage) (at 20°C 68°F) (Initial)	Max. 5 ms (excluding contact bounce time) (Without diode)		
Mechanical characteristics	Shock resistance	Functional	200 m/s ² (Half-wave pulse of sine wave: 11 ms; detection time: 10μs.)
		Destructive	1,000 m/s ² (Half-wave pulse of sine wave: 6 ms.)
	Vibration resistance	Functional	10 to 55 Hz at double amplitude of 1.5 mm (Detection time: 10μs.)
		Destructive	10 to 55 Hz at double amplitude of 1.5 mm
Expected life	Mechanical (at 180 times/min.)	Min. 10 ⁶	
	Electrical	Min. 10 ⁵ (ON: 1.5s, OFF: 1.5s, at nominal switching capacity)	Min. 5×10 ⁴ (ON: 1.5s, OFF: 1.5s, at nominal switching capacity)
Conditions	Conditions for operation, transport and storage*3	Ambient temperature: -40°C to +70°C -40°F to +158°F, Humidity: 5 to 85% R.H. (Not freezing and condensing at low temperature), Air pressure: 86 to 106kPa	
	Max. operating speed	20 times/min. (at nominal switching capacity)	
Unit weight		Approx. 12 g .42 oz	

Notes: *1. This value can change due to the switching frequency, environmental conditions, and desired reliability level, therefore it is recommended to check this with the actual load.

*2. Wave is standard shock voltage of $\pm 1.2 \times 50\mu s$ according to JEC-212-1981

*3. The upper limit of the ambient temperature is the maximum temperature that can satisfy the coil temperature rise value. Refer to Usage, transport and storage conditions in NOTES.

REFERENCE DATA

1. Max. switching power (AC resistive load)

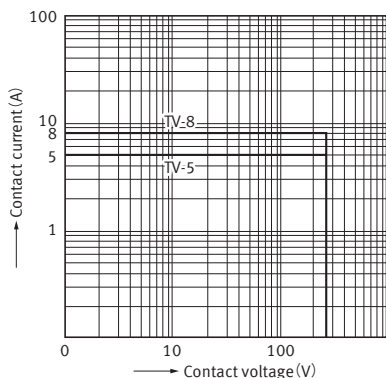

2-(1). Coil temperature rise (TV-5 type)

Tested sample : LKQ1aF-12V-TV5, 6 pcs.
Measured portion : Coil inside
Contact current : 0A, 5A

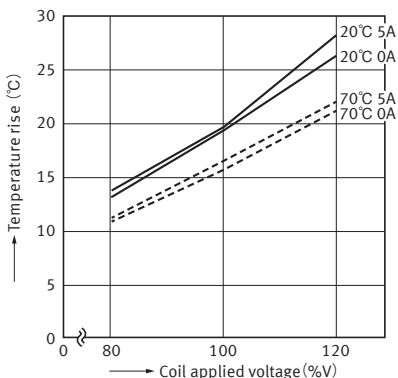

2-(2). Coil temperature rise (TV-8 type)

Tested sample : LKQ1aF-12V-TV8, 6 pcs.
Measured portion : Coil inside
Contact current : 0A, 8A

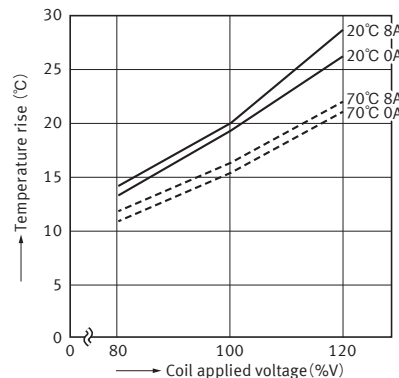

3-(1). Ambient temperature characteristics and coil applied voltage (TV-5 type)

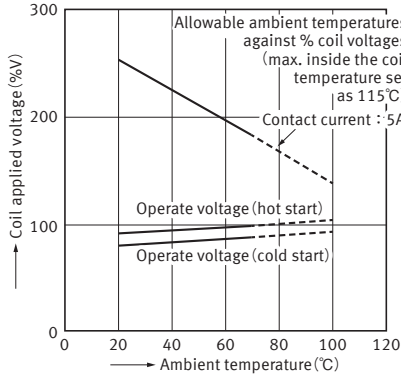

3-(2). Ambient temperature characteristics and coil applied voltage (TV-8 type)

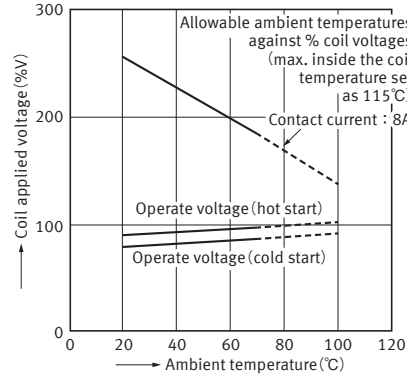

4-(1). Electrical life test (TV-5 type)
(5A 277V AC, resistive load)

Tested sample : LKQ1aF-12V-TV5, 6 pcs.
Operation frequency : 20 times/min.
(ON : OFF=1.5s : 1.5s)
Ambient temperature : 20°C
Circuit :

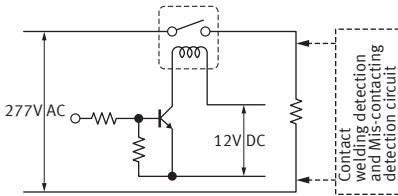

Change of operate and release voltage

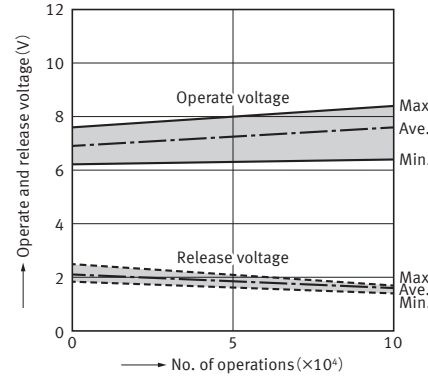

Change of contact resistance

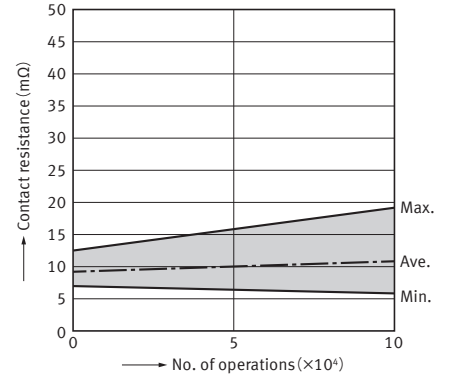

4-(2). Electrical life test (TV-8 type)
(8A 277V AC, resistive load)

Tested sample : LKQ1aF-12V-TV8, 6 pcs.
Operation frequency : 20 times/min.
(ON : OFF=1.5s : 1.5s)
Ambient temperature : 20°C
Circuit :

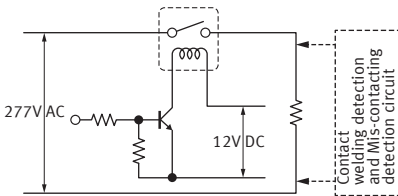

Change of operate and release voltage

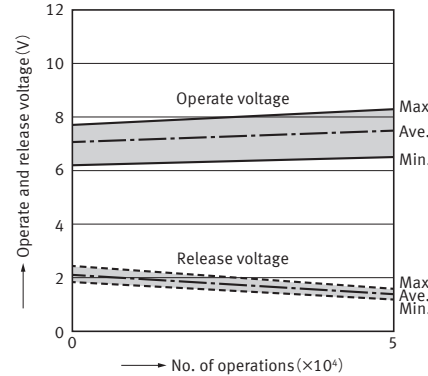

Change of contact resistance

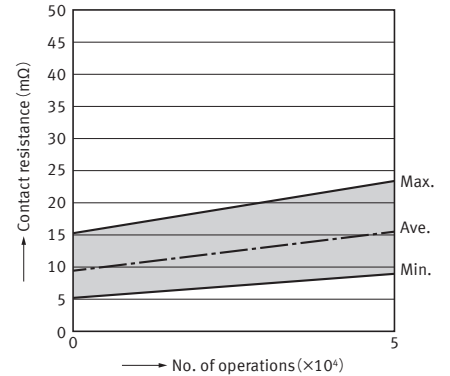

5-(1). Operation noise distribution
Measuring conditions

Measuring conditions
Tested sample : LKQ1aF-12V-TV5, 50 pcs.
Background noise : approx. 20dB
Coil voltage : 12V DC
Equipment setting : "A" weighted
Single part (refer to figure below)
With diode

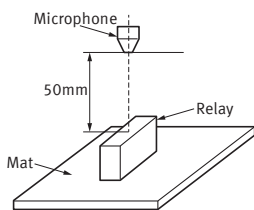

When operate (At contact making)

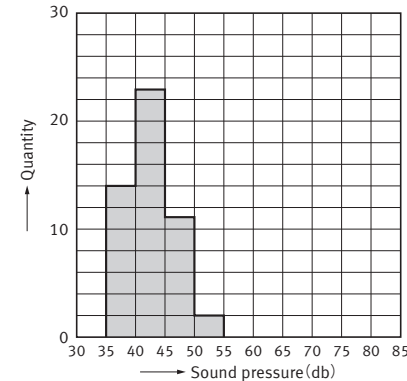

When release (At contact breaking)

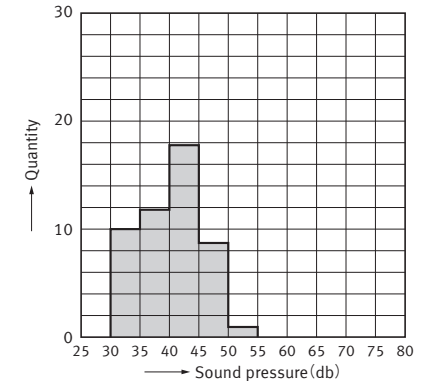

5-(2). Operation noise distribution
(refer to comparison)

Measuring conditions
 Tested sample : LKQ1aF-12V, 50 pcs.
 Background noise : approx. 20dB
 Coil voltage : 12V DC
 Equipment setting : "A" weighted
 Single part (refer to figure below)
 With diode

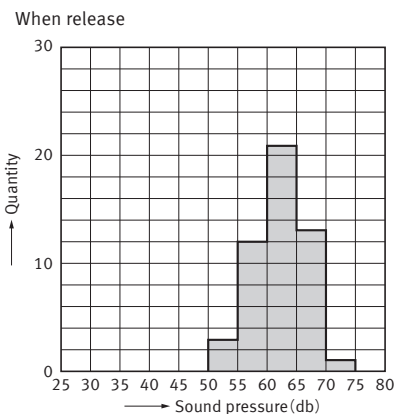
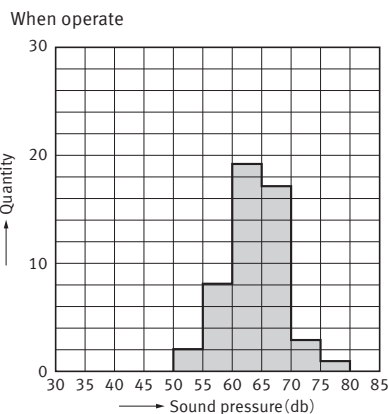
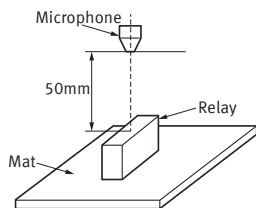

DIMENSIONS (mm)

CAD The CAD data of the products with a "CAD" mark can be downloaded from our Website.

CAD



External dimensions

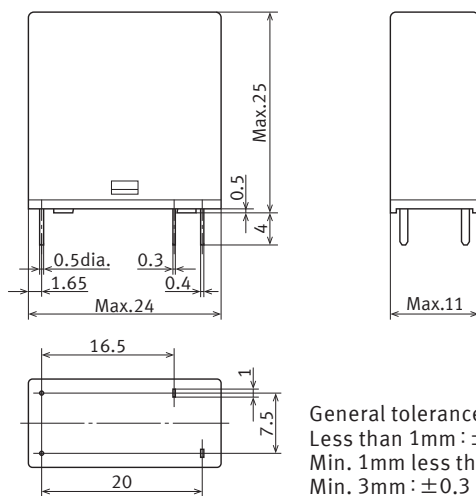

PC board pattern (Bottom view)

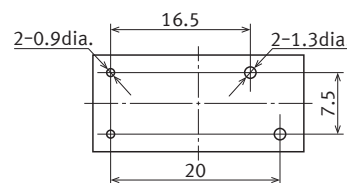

Tolerance ±0.1

Schematic (Bottom view)



SAFETY STANDARDS

Item	UL/C-UL (Recognized)			TÜV (Certified)			SEMKO (Certified)		TV rating (UL/C-UL)	
	File No.	Contact rating	Cycles	File No.	Contact rating	Cycles	File No.	Contact rating	File No.	Contact rating
TV-5 type	E43149	10A277V AC General use	5×10 ⁴	B 12 09 13461 333	5A250V AC (cosφ=1.0)	10 ⁵	1408509	3A/100A250V AC	E43149	TV-5
		5A277V AC General use	10 ⁵							
		5A 30V DC Resistive	10 ⁵							
TV-8 type	E43149	10A277V AC General use	5×10 ⁴	B 12 09 13461 333	8A250V AC (cosφ=1.0)	2×10 ⁴	1408509	3/100A 250V AC	E43149	TV-8
		8A277V AC General use	5×10 ⁴							
		5A277V AC General use	10 ⁵							
		5A 30V DC Resistive	10 ⁵							

* CSA standard: Certified by C-UL

NOTES

1. For cautions for use, please read "GENERAL APPLICATION GUIDELINES".

Please refer to "the latest product specifications" when designing your product.
 • Requests to customers :
<https://industrial.panasonic.com/ac/e/salespolicies/>

GUIDELINES FOR POWER, HIGH-CAPACITY DC CUT OFF AND SAFETY RELAYS USAGE

■ For cautions for use, please read “GUIDELINES FOR RELAY USAGE”.
https://industrial.panasonic.com/ac/e/control/relay/cautions_use/index.jsp

Precautions for Coil Input

■ Long term current carrying

A circuit that will be carrying a current continuously for long periods without relay switching operation. (circuits for emergency lamps, alarm devices and error inspection that, for example, revert only during malfunction and output warnings with form B contacts)
Continuous, long-term current to the coil will facilitate deterioration of coil insulation and characteristics due to heating of the coil itself. For circuits such as these, please use a magnetic-hold type latching relay. If you need to use a single stable relay, use a sealed type relay that is not easily affected by ambient conditions and make a failsafe circuit design that considers the possibility of contact failure or disconnection.

■ DC Coil operating power

Steady state DC current should be applied to the coil. The wave form should be rectangular. If it includes ripple, the ripple factor should be less than 5%.

However, please check with the actual circuit since the electrical characteristics may vary. The rated coil voltage should be applied to the coil and the set/reset pulse time of latching type relay differs for each relays, please refer to the relay's individual specifications.

■ Coil connection

When connecting coils of polarized relays, please check coil polarity (+,-) at the internal connection diagram (Schematic). If any wrong connection is made, it may cause unexpected malfunction, like abnormal heat, fire and so on, and circuit do not work. Avoid impressing voltages to the set coil and reset coil at the same time.

■ Maximum allowable voltage and temperature rise

Proper usage requires that the rated coil voltage be impressed on the coil. Note, however, that if a voltage greater than or equal to the maximum continuous voltage is impressed on the coil, the coil may burn or its layers short due to the temperature rise. Furthermore, do not exceed the usable ambient temperature range listed in the catalog.

■ Operate voltage change due to coil temperature rise

In DC relays, after continuous passage of current in the coil, if the current is turned OFF, then immediately turned ON again, due to the temperature rise in the coil, the pick-up voltage will become somewhat higher. Also, it will be the same as using it in a higher temperature atmosphere. The resistance/temperature relationship for copper wire is about 0.4% for 1°C, and with this ratio the coil resistance increases. That is, in order to operate of the relay, it is necessary that the voltage be higher than the pick-up voltage and the pick-up voltage rises in accordance with the increase in the resistance value. However, for some polarized relays, this rate of change is considerably smaller.

Ambient Environment

■ Usage, Transport, and Storage Conditions

During usage, storage, or transportation, avoid locations subjected to direct sunlight and maintain normal temperature, humidity and pressure conditions.

● Temperature/Humidity/Pressure

When transporting or storing relays while they are tube packaged, there are cases the temperature may differ from the allowable range. In this case be sure to check the individual specifications. Also allowable humidity level is influenced by temperature, please check charts shown below and use relays within mentioned conditions. (Allowable temperature values differ for each relays, please refer to the relay's individual specifications.)

1) Temperature:

The tolerance temperature range differs for each relays, please refer to the relay's individual specifications

2) Humidity: 5 to 85 % RH

3) Pressure: 86 to 106 kPa

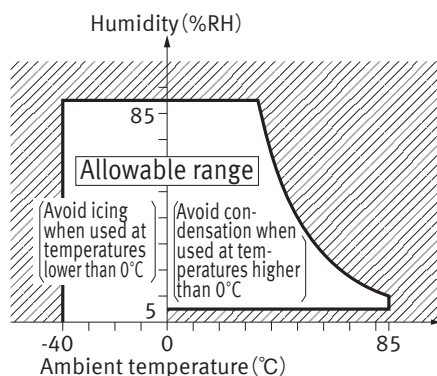

● Dew condensation

Condensation occurs when the ambient temperature drops suddenly from a high temperature and humidity, or the relay is suddenly transferred from a low ambient temperature to a high temperature and humidity. Condensation causes the failures like insulation deterioration, wire disconnection and rust etc. Panasonic Corporation does not guarantee the failures caused by condensation.

The heat conduction by the equipment may accelerate the cooling of device itself, and the condensation may occur.

Please conduct product evaluations in the worst condition of the actual usage. (Special attention should be paid when high temperature heating parts are close to the device. Also please consider the condensation may occur inside of the device.)

● Icing

Condensation or other moisture may freeze on relays when the temperature become lower than 0°C. This icing causes the sticking of movable portion, the operation delay and the contact conduction failure etc. Panasonic Corporation does not guarantee the failures caused by the icing.

The heat conduction by the equipment may accelerate the cooling of relay itself and the icing may occur. Please conduct product evaluations in the worst condition of the actual usage.

● Low temperature and low humidity

The plastic becomes brittle if the switch is exposed to a low temperature, low humidity environment for long periods of time.

● High temperature and high humidity

Storage for extended periods of time (including transportation periods) at high temperature or high humidity levels or in atmospheres with organic gases or sulfide gases may cause a sulfide film or oxide film to form on the surfaces of the contacts and/or it may interfere with the functions. Check out the atmosphere in which the units are to be stored and transported.

● Package

In terms of the packing format used, make every effort to keep the effects of moisture, organic gases and sulfide gases to the absolute minimum.

● Silicon

When a source of silicone substances (silicone rubber, silicone oil, silicone coating materials and silicone filling materials etc.) is used around the relay, the silicone gas (low molecular siloxane etc.) may be produced.

This silicone gas may penetrate into the inside of the relay. When the relay is kept and used in this condition, silicone compound may adhere to the relay contacts which may cause the contact failure.

Do not use any sources of silicone gas around the relay (Including plastic seal types).

● NOx Generation

When relay is used in an atmosphere high in humidity to switch a load which easily produces an arc, the NOx created by the arc and the water absorbed from outside the relay combine to produce nitric acid.

This corrodes the internal metal parts and adversely affects operation.

Avoid use at an ambient humidity of 85%RH or higher (at 20°C). If use at high humidity is unavoidable, please contact our sales representative.

Others

■ Cleaning

• Although the environmentally sealed type relay (plastic sealed type, etc.) can be cleaned, avoid immersing the relay into cold liquid (such as cleaning solvent) immediately after soldering. Doing so may deteriorate the sealing performance.

• Cleaning with the boiling method is recommended(The temperature of cleaning liquid should be 40°C or lower).

Avoid ultrasonic cleaning on relays. Use of ultrasonic cleaning may cause breaks in the coil or slight sticking of the contacts due to ultrasonic energy.

Please refer to **"the latest product specifications"** when designing your product.

•Requests to customers:

<https://industrial.panasonic.com/ac/e/salespolicies/>

Please contact

Panasonic Corporation

Electromechanical Control Business Division

■ 1006, Oaza Kadoma, Kadoma-shi, Osaka 571-8506, Japan
industrial.panasonic.com/ac/e/

Panasonic[®]

©Panasonic Corporation 2019