

# Common Mode Noise Filters Array

## EXC28CE type



### Features

- Small and thin type, two built-in filter circuit (L 2.0 mm×W 1.0 mm×H 0.5 mm)
- Elimination of radiation noises from high-speed differential transmissions
- Magnetic shield type with no leakage
- Strong multilayer/sintered structure, excellent reflow resistance and high mounting reliability
- Lead, halogen and antimony-free
- RoHS compliant

### Recommended applications

- AV equipment (LCD-TV, DVD/Blu-ray drives), Information equipment (PCs, HDD, Printers), Communications equipment (Mobile phones, Smartphones)
- Noise suppression of high-speed differential data lines such as USB2.0 and LVDS

### Explanation of part numbers

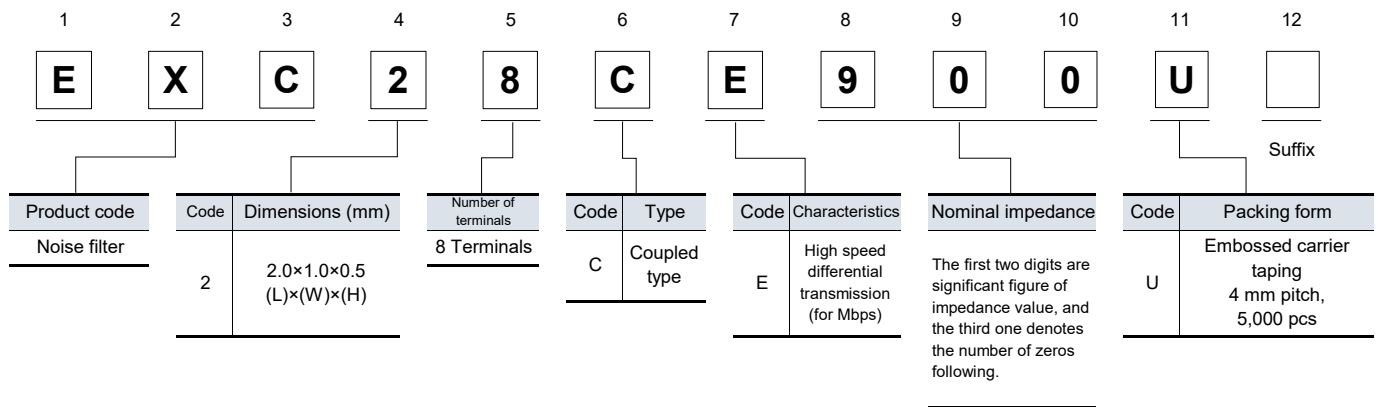

### Construction

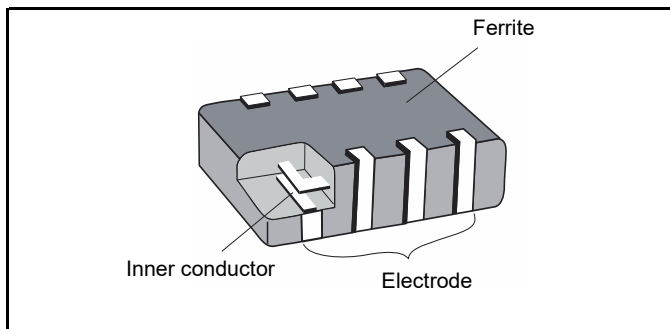

### Circuit configuration (No polarity)

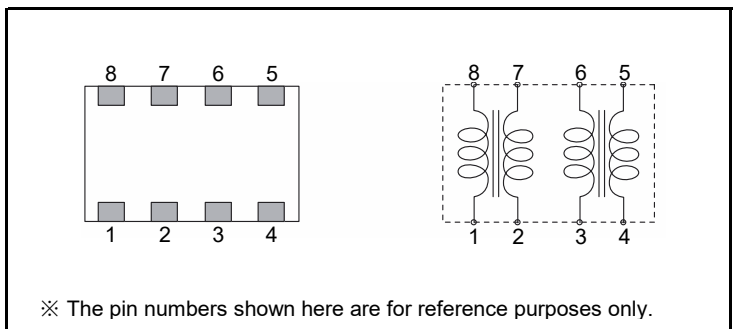

### Dimensions in mm (not to scale)

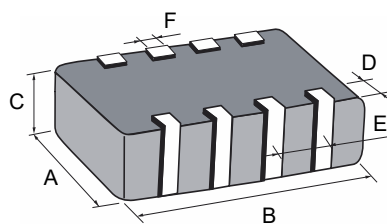

| Part No.<br>(inch size) | Dimensions  |           |           |            |           |            | Mass (Weight)<br>(mg/ pc.) |
|-------------------------|-------------|-----------|-----------|------------|-----------|------------|----------------------------|
|                         | A           | B         | C         | D          | E         | F          |                            |
| EXC28CE (0804)          | 1.00 ± 0.15 | 2.0 ± 0.2 | 0.5 ± 0.1 | 0.2 ± 0.15 | 0.5 ± 0.1 | 0.25 ± 0.1 | 5.0                        |

Unit : mm

**Ratings**

| Part number | Impedance ( $\Omega$ ) at 100 MHz |                   | Rated voltage (V) DC | Rated current (mA) DC | DC resistance ( $\Omega$ ) max. |
|-------------|-----------------------------------|-------------------|----------------------|-----------------------|---------------------------------|
|             | Common mode                       | Differential mode |                      |                       |                                 |
| EXC28CE900U | 90 $\Omega \pm 25\%$              | 15 $\Omega$ max.  | 5                    | 160                   | 1.5                             |
| EXC28CE121U | 120 $\Omega \pm 25\%$             | 18 $\Omega$ max.  | 5                    | 140                   | 2.0                             |
| EXC28CE201U | 200 $\Omega \pm 25\%$             | 20 $\Omega$ max.  | 5                    | 130                   | 2.5                             |

● Category temperature range  $-40\text{ }^{\circ}\text{C}$  to  $+85\text{ }^{\circ}\text{C}$

**Impedance characteristics (Typical)**

● EXC28CE900U

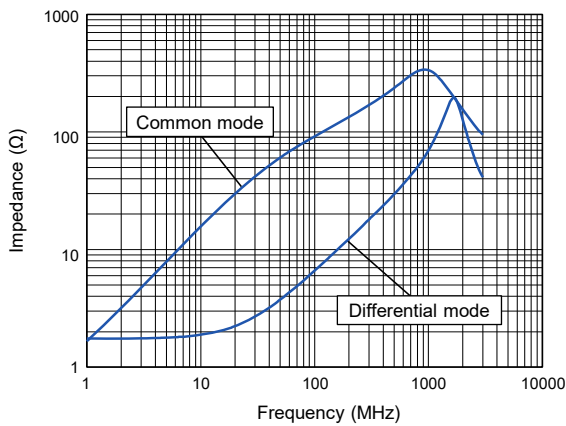

● EXC28CE121U

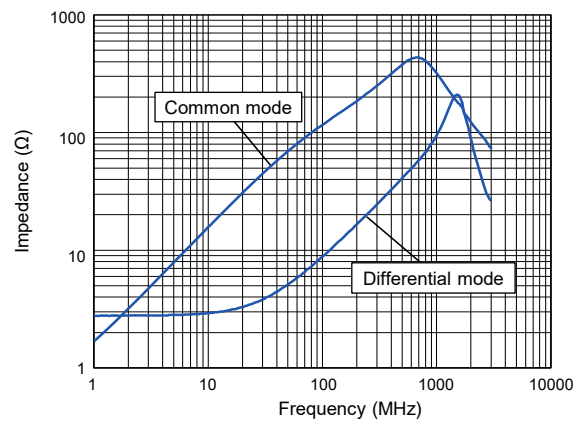

● EXC28CE201U

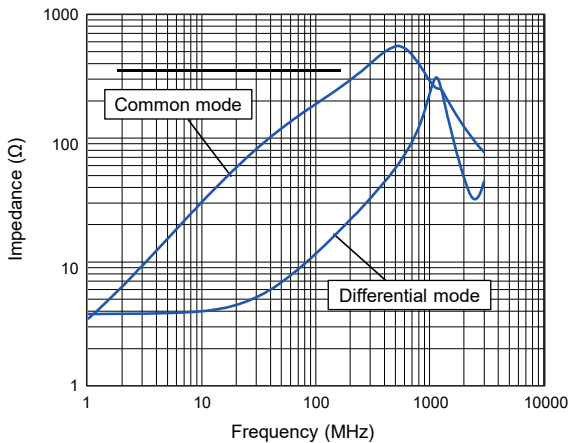

● Measurement circuit

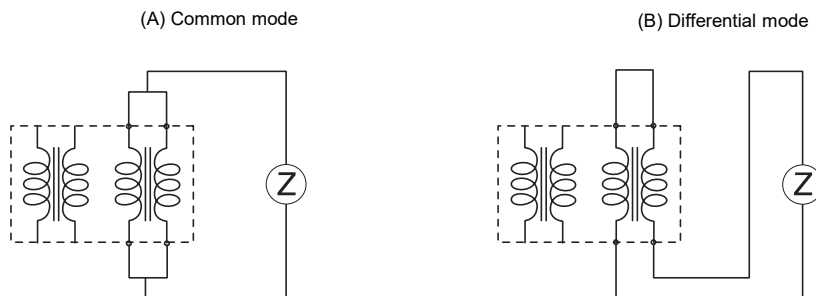

■ As for packaging methods, soldering conditions and safety precautions, please see data files

## Common Mode Noise Filters / Common performance

| Performance                  |                            |   |
|------------------------------|----------------------------|---|
| Test item                    | Performance requirements   | Test conditions resistance                      |
| Resistance                   | Within specified tolerance | 25 °C   |
| Overload                     | —                          | Rated voltage                                   |
| Resistance to soldering heat | ±30 % (Impedance change)   | 260 °C, 10 s                                    |
| Rapid change of temperature  | ±30 % (Impedance change)   | -40 °C (30 min.) / +85 °C (30 min.), 200 cycles |
| High temperature exposure    | ±30 % (Impedance change)   | 85 °C , 500 h                                   |
| Damp heat, Steady state      | ±30 % (Impedance change)   | 60 °C, 95 %RH, 500 h                            |
| Load life in humidity        | ±30 % (Impedance change)   | 60 °C, 95 %RH, Rated current, 500 h             |

## Safety and Legal Matters to Be Observed

### Product specifications and applications

- Please be advised that this product and product specifications are subject to change without notice for improvement purposes. Therefore, please request and confirm the latest delivery specifications that explain the specifications in detail before the final design, or purchase or use of the product, regardless of the application. In addition, do not use this product in any way that deviates from the contents of the company's delivery specifications.
- Unless otherwise specified in this catalog or the product specifications, this product is intended for use in general electronic equipment (AV products, home appliances, commercial equipment, office equipment, information and communication equipment, etc.).  
When this product is used for the following special cases, the specification document suited to each application shall be signed/sealed (with Panasonic Industry and the user) in advance..These include applications requiring special quality and reliability, wherein their failures or malfunctions may directly threaten human life or cause harm to the human body (e.g.: space/aircraft equipment, transportation/traffic equipment, combustion equipment, medical equipment, disaster prevention/crime prevention equipment, safety equipment, etc.).

### Safety design and product evaluation

- Please ensure safety through protection circuits, redundant circuits, etc., in the customer's system design so that a defect in our company's product will not endanger human life or cause other serious damage.
- This catalog shows the quality and performance of individual parts. The durability of parts varies depending on the usage environment and conditions. Therefore, please ensure to evaluate and confirm the state of each part after it has been mounted in your product in the actual operating environment before use.  
If you have any doubts about the safety of this product, then please notify us immediately, and be sure to conduct a technical review including the above protection circuits and redundant circuits at your company.

### Laws / Regulations / Intellectual property

- The transportation of dangerous goods as designated by UN numbers, UN classifications, etc., does not apply to this product. In addition, when exporting products, product specifications, and technical information described in this catalog, please comply with the laws and regulations of the countries to which the products are exported, especially those concerning security export control.
- Each model of this product complies with the RoHS Directive (Restriction of the use of hazardous substances in electrical and electronic equipment) (2011/65/EU and (EU) 2015/863). The date of compliance with the RoHS Directive and REACH Regulation varies depending on the product model.  
Further, if you are using product models in stock and are not sure whether or not they comply with the RoHS Directive or REACH Regulation, please contact us by selecting "Sales Inquiry" from the inquiry form.
- During the manufacturing process of this product and any of its components and materials to be used, Panasonic Industry does not intentionally use ozone-depleting substances stipulated in the Montreal Protocol and specific bromine-based flame retardants such as PBBs (Poly-Brominated Biphenyls) / PBDEs (Poly-Brominated Diphenyl Ethers). In addition, the materials used in this product are all listed as existing chemical substances based on the Act on the Regulation of Manufacture and Evaluation of Chemical Substances.
- With regard to the disposal of this product, please confirm the disposal method in each country and region where it is incorporated into your company's product and used.
- The technical information contained in this catalog is intended to show only typical operation and application circuit examples of this product. This catalog does not guarantee that such information does not infringe upon the intellectual property rights of Panasonic Industry or any third party, nor imply that the license of such rights has been granted.
- Design, materials, or process related to technical owned by Panasonic Industry are subject to change without notice.

**Panasonic Industry will assume no liability whatsoever if the use of our company's products deviates from the contents of this catalog or does not comply with the precautions. Please be advised of these restrictions.**

## Matters to Be Observed When Using This Product

(Common mode noise filter)

### Use environments and cleaning conditions

- This product is not designed for use in specific environments. Using this product in the following specific environments or service conditions may affect the performance/reliability of this product. Avoid using it in such specific environments. If you intend to use this product in such environments, checking the performance, reliability, etc., of the product sufficiently is your own responsibility.
  - (1) Used in liquid, such as water, oil, chemicals, and organic solvents.
  - (2) Used in a place exposed to direct sunlight, an outdoor place with no shielding, or a dusty place.
  - (3) Used in a place where the product is heavily exposed to sea breeze or a corrosive gas, such as Cl<sub>2</sub>, H<sub>2</sub>S, NH<sub>3</sub>, SO<sub>2</sub>, or NO<sub>x</sub>.
  - (4) Used in an environment where static electricity and electromagnetic waves are strong.
  - (5) Located close to a heating component or a flammable material, such as a vinyl cable placed near the product.
  - (6) Sealed or coated with a resin.
  - (7) Solder flux of this product soldered with no-clean type solder, etc., is cleansed with a solvent, water, or a water-soluble cleaner, etc. (Water-soluble flux residues have a particularly large influence on this product.)
  - (8) Used in a place where dew concentrates on the product.
  - (9) Used in a contaminated state.

(Example: Touching this product mounted on a printed circuit board with sebum still attached. (improper handling))
- Sealing this product with a resin in a resin potting process, damp-proofing process, etc., applies excessive stress to this product, which may cause the internal electrodes a connection problem. In such cases, the proper operation of this product is not guaranteed. If you intend to use this product in such environments, checking the performance, reliability, etc., of the product sufficiently is your own responsibility.
- Do not leave this product immersed in a solvent for a long time. When using this product immersed in a solvent, confirm the operation of the product mounted on the board.
- When a cleaning solution or cleaning condition for cleaning the printed board or a drying condition for drying the printed board after soldering this product is improper, it may have a negative effect on the performance/reliability of this product. Confirming these conditions sufficiently is your own responsibility. Also examine the effects of soiled cleaning agent, cleaning residues, and post-cleaning contaminations, and control for these effects properly.

### Response to anomalies and handling conditions

- When this product is heating abnormally or emitting a smell, stop using this product immediately, for example, turn off the main power supply of the device.

Also, keep your face and hands away from the product as it may become hot and cause burns.
- This product is so thin that it may break easily when subjected to impact. Before putting this product in use, confirm that this product has not been broken by impact that applied thereto when mounted on the printed board. Applying impact to this product or pinching this product with a hard tool (pliers, tweezers, etc.) may chip this product or its protective film, which affects its performance. Be careful to avoid such cases.
- Do not reuse this product having been used on a printed board and removed therefrom. Do not touch this product with your bare hands.
- Be careful not to drop this product on the floor, etc. This product is likely to suffer mechanical or electrical damage when dropped on the floor. Avoid using said this product.
- This product may have its characteristics value changed due to electrostatic discharge (ESD). Take ESD prevention measures when handling this product. ESD prevention measures include an environment where static electricity is not likely to be generated (recommended RH: 40% to 60%), by wearing an earth band, conductive gloves, etc., grounding the device in which this product is incorporated, and placing a conductive mat, etc., on a work platform.
- It is guaranteed that this product not exposed to any stress will have its proper characteristics value. Any stress or pressure applied to this product may cause its characteristics value to change. Examine and evaluate the characteristics of this product sufficiently before using it.

## Reliability and product life

A product conforming to "AEC-Q200" refers to a product having passed some or all of the evaluation test items defined in AEC-Q200. To know the detailed specifications of individual products or specific evaluation test scores, please contact us. We issue a delivery specification sheet for each product ordered. Please confirm with the sheet when you place an order with us.

## Circuit design and circuit board design

- To prevent a case where a transient load (e.g., a pulse applied for a short period) too large for the filter to handle is applied to the filter, make sure to evaluate and confirm the operation of the filter incorporated in your product. Applying a voltage or current larger than the rated voltage or current to the filter may impair its performance and reliability. Make sure to use the filter with voltage or current equal to or lower than the rated voltage or current. The product warranty does not cover usage where an excessively large load, such as a pulse current, is applied to the product.
- Be careful that unusual stress caused by an excessive bend of the printed board is not applied to this product. Design the circuit structure such that this product is not close to a perforated line for board splitting or on a line with sizable holes bored on the board.
- When a different component is mounted on the board where this product has been soldered, be careful that the board does not bend excessively. If necessary, provide the board with backup pins (support pins) to keep it straight.
- Avoid manual board splitting. Use a jig, etc., to break the board so that it does not bend excessively when split apart.

## Mounting conditions

- When the product is used under mounting conditions departing from mounting conditions specified in our specification sheet, the product may be exposed to unexpected stress to fail. Be careful to avoid such a case. Make sure to evaluate and confirm the operation of the filter incorporated in your product and determine whether the filter is usable as a component of the product.
- Set soldering conditions for this product within the recommended soldering conditions specified by our company. Any time, soldering condition departing from the specified soldering condition, such as a high peak temperature or a long heating may impair the performance/reliability of this product. Note that the specified soldering conditions indicate conditions under which degradation of this product characteristics does not occur but do not indicate conditions under which stable soldering can be performed. Check and set individual conditions under which stable soldering can be performed.
- Heat this product in advance so that a difference between the soldering temperature and the temperature of this product surface is reduced to 100 °C or lower. When dipping the soldered product in a solvent, etc., to cool this product rapidly, ensure that the temperature difference between this product and the solvent is 100 °C or lower during the dipping.
- When soldering the filter using a soldering iron, apply hot air, etc., to the filter to heat it sufficiently in advance and then solder the filter without bringing the soldering iron tip into contact with the product. If the temperature of the soldering iron tip is high, finish the soldering work quickly (within 3 seconds when the temperature of the soldering iron tip is 350°C or lower). The volume of solder (fillet size) used when mounting the filter on the board may affect the performance of the filter. Make sure to confirm the solder volume of the soldering work on the actual product.
- Soldering this product with too much solder or too little solder results in the poor reliability of the solder connection of this product. Use the proper volume of solder in the soldering process. Sufficiently check for the volume of solder used.
- Soldering with high bond strength or special property solder may affect the quality of this product. Do not use such solder.
- Use rosin-based solder flux. When using highly active solder flux made mainly of halogen (chlorine, bromine, etc.), flux residues may affect the performance and reliability of this product. Check the effects of flux residues before using the solder flux. Do not use highly acidic flux, water-soluble flux, or flux containing fluoride ions. When solder flux sticks to this product after the soldering process, the activation energy of the flux may corrode this product and cause it to fail. Prevent solder flux from sticking to this product.

## Storage conditions

Keeping the product in the following environments or conditions may lead to degradation of its performance, solderability, etc. Do not keep the product in the following environments.

- (1) Stored in a place where the product is heavily exposed to sea breeze or a corrosive gas, such as Cl<sub>2</sub>, H<sub>2</sub>S, NH<sub>3</sub>, SO<sub>2</sub>, or NO<sub>x</sub>.
- (2) Stored in a place where the product is exposed to direct sunlight.
- (3) Stored in a place where a temperature condition of 5 °C to 35 °C and a relative humidity condition of 45% to 85% cannot be maintained.
- (4) Kept in storage for more than one year from the delivery date (when the product is kept in conditions excluding any of the environments (1) to (3)).