

Varistors (ZNR Surge Absorber)

E type



Varistors (ZNR Surge Absorber) Type E is capable of handling larger surge energy than Type D in applications to protect electronic equipment or semiconductor devices from switching and induced lightning surges.

Features

- UL and CSA recognized components
- Very large surge withstanding capability with a compact size
- Direct mounting on boards like a power distribution board available
- Fast response to steep impulse voltage
- Low clamping voltage for better surge protection
- RoHS compliant

Recommended applications

- Transistor, diode, IC, thyristor or triac semiconductor protection
- Surge protection in industrial power plant operations
- Relay or electromagnetic valve surge absorption
- Surge absorption applications in broadcasting, communications devices, traffic/railroad, agricultural facilities, waterworks
- Surge protection of automatic control devices for power distribution line

Related standards

Standard No.	UL1449	CSA C22.2 No.269.5
Title	Surge protective devices	Surge protective devices - Type 5 – Components

- Each type designation is not registered by Part Number.

Note : Ask our factory for Product Specification before use.

- As for handling precautions and minimum quantity / Packing unit please see related information.

Explanation of part numbers

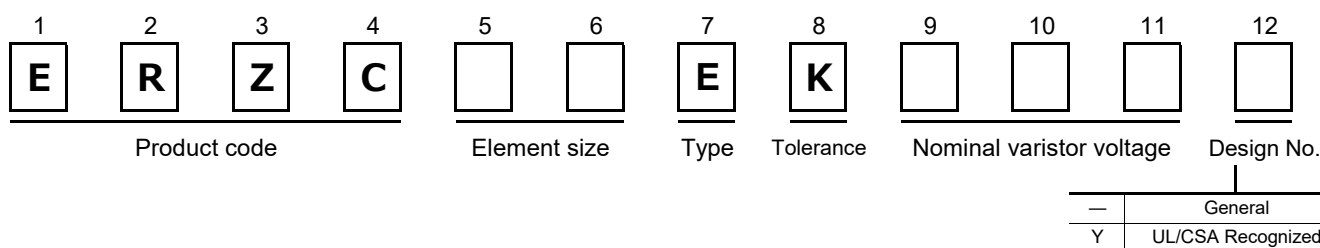

Dimensions in mm (not to scale)

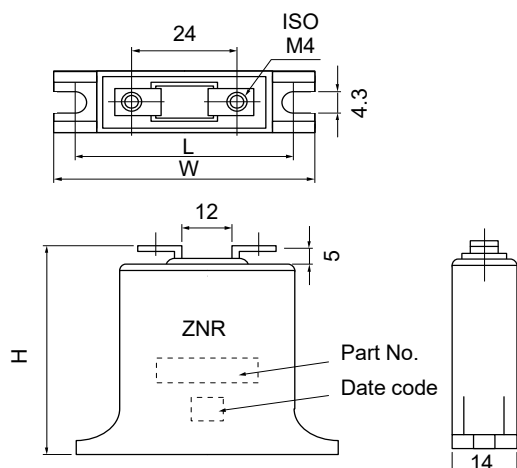

Unit : mm

Part No.	W	H	L
ERZC20EK□□□(Y)	48±1	42±1	39±1
ERZC32EK□□□(Y)	60±1	55±1	51±1

E type / 20, 32 series (UL and CSA Recognized)

Ratings and characteristics (20 series)

● Operating temperature range : -40 to 85 °C

● Storage temperature range : -40 to 110 °C

Part No. (UL/CSA Recognized)	Type designation	Varistor voltage at 1 mA	Maximum allowable voltage		Maximum clamping voltage at 100 A	Maximum energy (2ms) 1 time	Maximum peak current (8/20μs)	Rated voltage (UL/CSA)
			(V)	Acrms (V)			DC (V)	
		ACrms (V)						
ERZC20EK201Y	20EK201U	200 (185 to 225)	130	170	340	80	8000	118
ERZC20EK241Y	20EK241U	240 (216 to 264)	150	200	395	95	8000	136
ERZC20EK271Y	20EK271U	270 (247 to 303)	175	225	455	100	8000	159
ERZC20EK361Y	20EK361U	360 (324 to 396)	230	300	595	120	8000	209
ERZC20EK391Y	20EK391U	390 (351 to 429)	250	320	650	130	8000	227
ERZC20EK431Y	20EK431U	430 (387 to 473)	275	350	710	140	8000	250
ERZC20EK471Y	20EK471U	470 (423 to 517)	300	385	775	150	8000	272
ERZC20EK511Y	20EK511U	510 (459 to 561)	320	415	845	150	8000	291
ERZC20EK621Y	20EK621U	620 (558 to 682)	385	505	1025	160	8000	350
ERZC20EK681Y	20EK681U	680 (612 to 748)	420	560	1120	175	8000	381
ERZC20EK751Y	20EK751U	750 (675 to 825)	460	615	1240	190	8000	418
ERZC20EK781Y	20EK781U	780 (702 to 858)	485	640	1290	200	8000	440
ERZC20EK821Y	20EK821U	820 (738 to 902)	510	670	1355	215	8000	463
ERZC20EK911Y	20EK911U	910 (819 to 1001)	550	745	1500	240	8000	500
ERZC20EK102Y	20EK102U	1000 (900 to 1100)	625	825	1650	245	8000	568
ERZC20EK112Y	20EK112U	1100 (990 to 1210)	680	895	1815	250	8000	600

Ratings and characteristics (32 series)

● Operating temperature range : -40 to 85 °C

● Storage temperature range : -40 to 110 °C

Part No. (UL/CSA Recognized)	Type designation	Varistor voltage at 1 mA	Maximum allowable voltage		Maximum clamping voltage at 200 A	Maximum energy (2ms) 1 time	Maximum peak current (8/20μs)	Rated voltage (UL/CSA)
			(V)	Acrms (V)			DC (V)	
		ACrms (V)						
ERZC32EK201Y	32EK201U	200 (185 to 225)	130	170	340	210	25000	118
ERZC32EK241Y	32EK241U	240 (216 to 264)	150	200	395	240	25000	136
ERZC32EK271Y	32EK271U	270 (247 to 303)	175	225	455	255	25000	159
ERZC32EK361Y	32EK361U	360 (324 to 396)	230	300	595	325	25000	209
ERZC32EK391Y	32EK391U	390 (351 to 429)	250	320	650	350	25000	227
ERZC32EK431Y	32EK431U	430 (387 to 473)	275	350	710	400	25000	250
ERZC32EK471Y	32EK471U	470 (423 to 517)	300	385	775	405	25000	272
ERZC32EK511Y	32EK511U	510 (459 to 561)	320	415	845	405	25000	291
ERZC32EK621Y	32EK621U	620 (558 to 682)	385	505	1025	415	25000	350
ERZC32EK681Y	32EK681U	680 (612 to 748)	420	560	1120	450	25000	381
ERZC32EK751Y	32EK751U	750 (675 to 825)	460	615	1240	500	25000	418
ERZC32EK781Y	32EK781U	780 (702 to 858)	485	640	1290	520	25000	440
ERZC32EK821Y	32EK821U	820 (738 to 902)	510	670	1355	545	25000	463
ERZC32EK911Y	32EK911U	910 (819 to 1001)	550	745	1500	600	25000	500
ERZC32EK102Y	32EK102U	1000 (900 to 1100)	625	825	1650	620	25000	568
ERZC32EK112Y	32EK112U	1100 (990 to 1210)	680	895	1815	640	25000	600

Ratings and characteristics (20 series)

● Operating temperature range : -40 to 85 °C

● Storage temperature range : -40 to 110 °C

Part No.	Varistor voltage at 1 mA (V)	Maximum allowable voltage		Maximum clamping voltage at 100 A (V)	Rated power (W)	Maximum energy (2ms) (J)	Maximum peak current (8/20 μs)		Typical capacitance (Reference) at 1 kHz (pF)
		Acrms (V)	DC (V)				1 time (A)	2 times (A)	
ERZC20EK201	200 (185 to 225)	130	170	340	0.8	80	8000	5000	2300
ERZC20EK241	240 (216 to 264)	150	200	395	0.8	95	8000	5000	1500
ERZC20EK271	270 (247 to 303)	175	225	455	0.8	100	8000	5000	1400
ERZC20EK361	360 (324 to 396)	230	300	595	0.8	120	8000	5000	1300
ERZC20EK391	390 (351 to 429)	250	320	650	0.8	130	8000	5000	1200
ERZC20EK431	430 (387 to 473)	275	350	710	0.8	140	8000	5000	1000
ERZC20EK471	470 (423 to 517)	300	385	775	0.8	150	8000	5000	950
ERZC20EK511	510 (459 to 561)	320	415	845	0.8	150	8000	5000	930
ERZC20EK621	620 (558 to 682)	385	505	1025	0.8	160	8000	5000	900
ERZC20EK681	680 (612 to 748)	420	560	1120	0.8	175	8000	5000	850
ERZC20EK751	750 (675 to 825)	460	615	1240	0.8	190	8000	5000	800
ERZC20EK781	780 (702 to 858)	485	640	1290	0.8	200	8000	5000	800
ERZC20EK821	820 (738 to 902)	510	670	1355	0.8	215	8000	5000	700
ERZC20EK911	910 (819 to 1001)	550	745	1500	0.8	240	8000	5000	700
ERZC20EK102	1000 (900 to 1100)	625	825	1650	0.8	245	8000	5000	400
ERZC20EK112	1100 (990 to 1210)	680	895	1815	0.8	250	8000	5000	350

Ratings and characteristics (32 series)

● Operating temperature range : -40 to 85 °C

● Storage temperature range : -40 to 110 °C

Part No.	Varistor voltage at 1 mA (V)	Maximum allowable voltage		Maximum clamping voltage at 200 A (V)	Rated power (W)	Maximum energy (2ms) (J)	Maximum peak current (8/20 μs)		Typical capacitance (Reference) at 1 kHz (pF)
		Acrms (V)	DC (V)				1 time (A)	2 times (A)	
ERZC32EK201	200 (185 to 225)	130	170	340	1.2	210	25000	20000	5500
ERZC32EK241	240 (216 to 264)	150	200	395	1.2	240	25000	20000	5000
ERZC32EK271	270 (247 to 303)	175	225	455	1.2	255	25000	20000	4200
ERZC32EK361	360 (324 to 396)	230	300	595	1.2	325	25000	20000	3500
ERZC32EK391	390 (351 to 429)	250	320	650	1.2	350	25000	20000	3000
ERZC32EK431	430 (387 to 473)	275	350	710	1.2	400	25000	20000	2500
ERZC32EK471	470 (423 to 517)	300	385	775	1.2	405	25000	20000	2500
ERZC32EK511	510 (459 to 561)	320	415	845	1.2	405	25000	20000	2400
ERZC32EK621	620 (558 to 682)	385	505	1025	1.2	415	25000	20000	2200
ERZC32EK681	680 (612 to 748)	420	560	1120	1.2	450	25000	20000	2100
ERZC32EK751	750 (675 to 825)	460	615	1240	1.2	500	25000	20000	2000
ERZC32EK781	780 (702 to 858)	485	640	1290	1.2	520	25000	20000	1900
ERZC32EK821	820 (738 to 902)	510	670	1355	1.2	545	25000	20000	1800
ERZC32EK911	910 (819 to 1001)	550	745	1500	1.2	600	25000	20000	1700
ERZC32EK102	1000 (900 to 1100)	625	825	1650	1.2	620	25000	20000	1000
ERZC32EK112	1100 (990 to 1210)	680	895	1815	1.2	640	25000	20000	800

Typical characteristics

Voltage vs. Current

(ERZC20EK201(Y) to ERZC20EK511(Y))

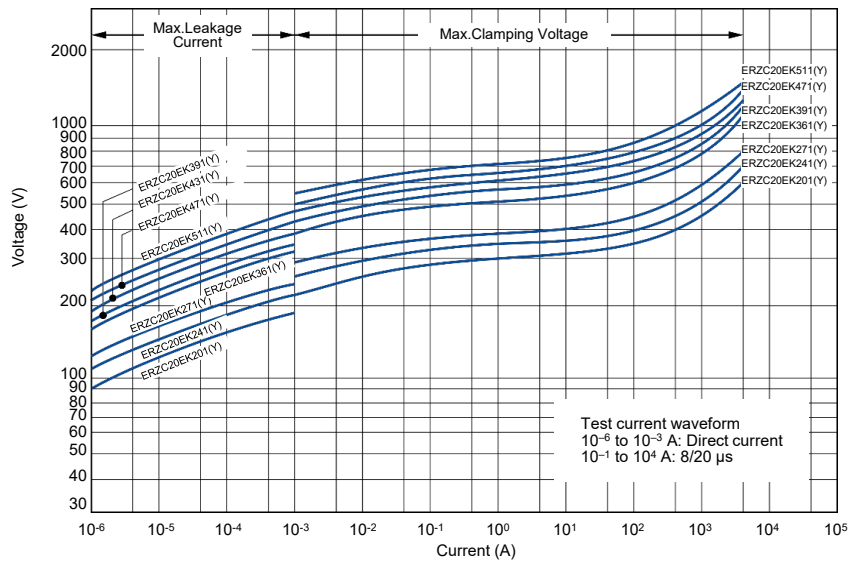

(ERZC20EK621(Y) to ERZC20EK112(Y))

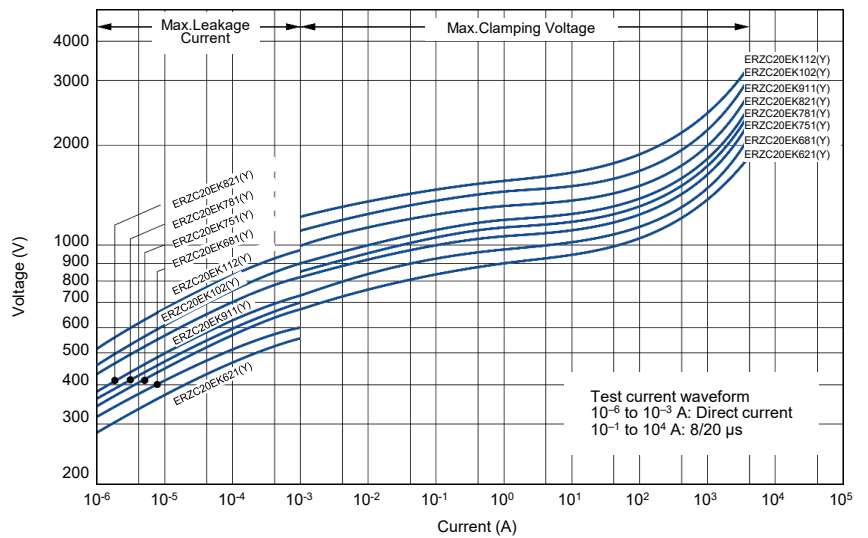

Impulse derating curve (Relation between impulse width and surge, repetitively)

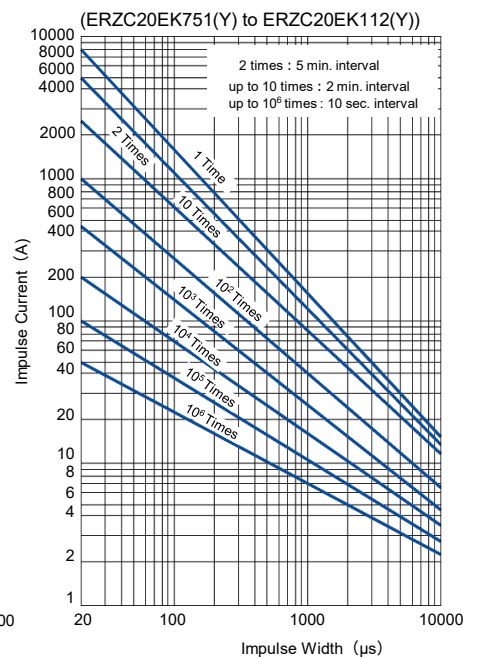
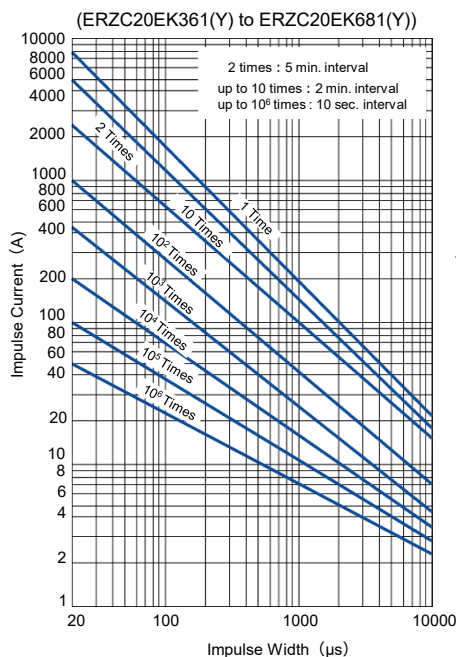
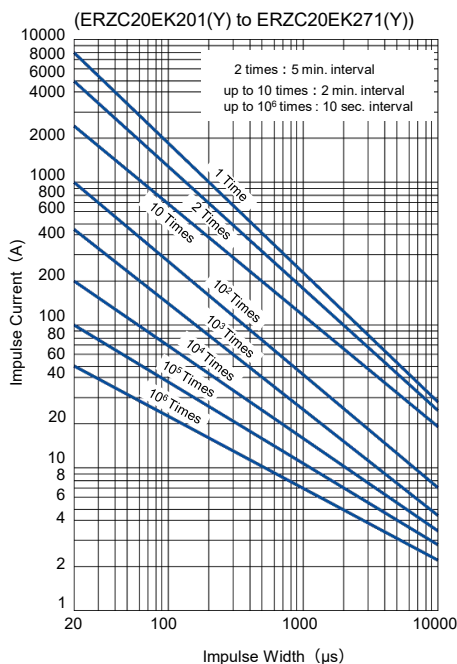

Typical characteristics

Voltage vs. Current

(ERZC32EK201(Y) to ERZC32EK511(Y))

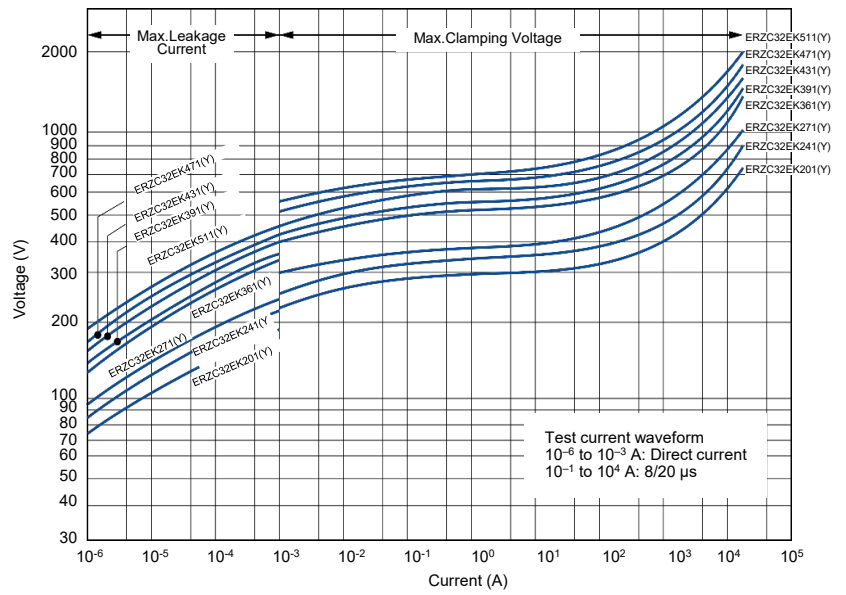

(ERZC32EK621(Y) to ERZC32EK112(Y))

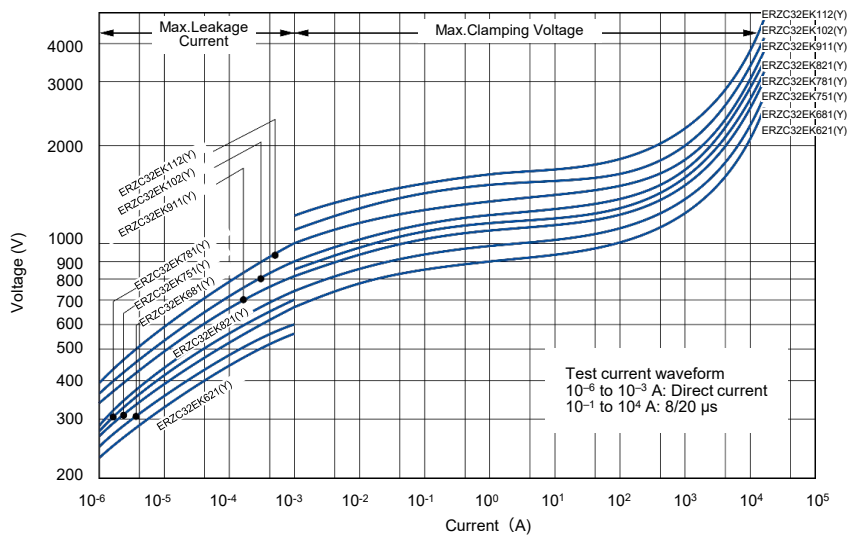

Impulse derating curve (Relation between impulse width and surge, repetitively)

(ERZC32EK201(Y) to ERZC32EK271(Y))

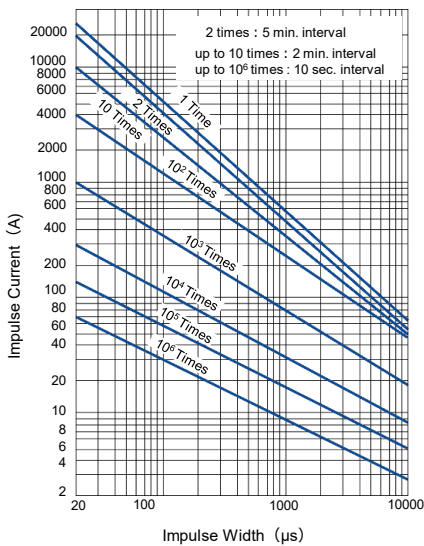

(ERZC32EK361(Y) to ERZC32EK681(Y))

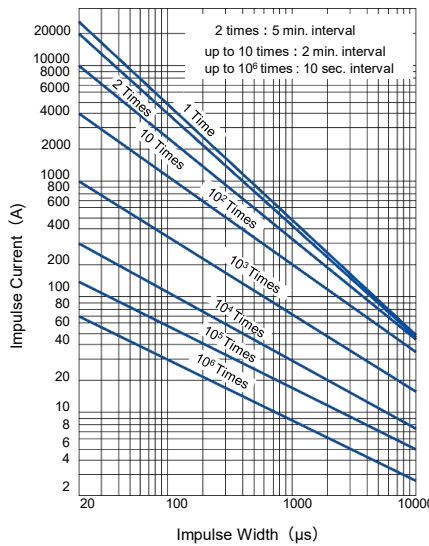

(ERZC32EK751(Y) to ERZC32EK112(Y))

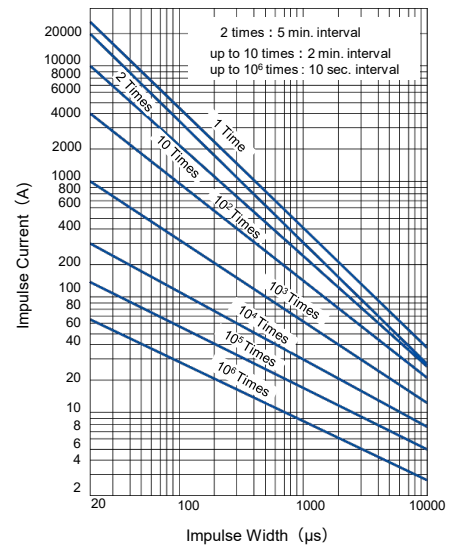

Performance characteristics

Characteristics		Test methods / Description	Specifications															
Electrical	Standard test condition	Electrical measurements (initial/after tests) shall be conducted at temperature of 5 to 35 °C, relative humidity of maximum 85 %.	—															
	Varistor voltage	The voltage between two terminals with the specified measuring current C_{mA} DC applied is called V_C or V_{CmA} . The measurement shall be made as fast as possible to avoid heat affection.	To meet the specified value															
	Maximum allowable voltage	The maximum sinusoidal wave voltage (rms) or the maximum DC voltage that can be applied continuously.																
	Clamping voltage	The maximum voltage between two terminals with the specified standard impulse current (8/20 μ s).																
	Rated power	The maximum power that can be applied within the specified ambient temperature.																
	Maximum energy	The maximum energy within the varistor voltage change of ± 10 % when one impulse of 2 ms is applied.																
	Maximum peak current	2 times		The maximum current within the varistor voltage change of ± 10 % with the standard impulse current (8/20 μ s) applied two times with an interval of 5 minutes.														
		1 time	The maximum current within the varistor voltage change of ± 10 % with the standard impulse current (8/20 μ s) applied one time.															
	Temperature coefficient of varistor voltage	$\frac{V_C \text{ at } 70^\circ\text{C} - V_C \text{ at } 20^\circ\text{C}}{V_C \text{ at } 20^\circ\text{C}} \times \frac{1}{50} \times 100(\%/^\circ\text{C})$	0 to -0.05 %/ °C max.															
	Impulse life	The change of VC shall be measured after the impulse current listed below is applied 10000 times continuously with the interval of 10 seconds at room temperature. <table border="1" style="margin-left: auto; margin-right: auto;"> <tr> <td>Series 20</td> <td>200 A (8/20 μs)</td> </tr> <tr> <td>Series 32</td> <td>300 A (8/20 μs)</td> </tr> </table>	Series 20	200 A (8/20 μ s)	Series 32	300 A (8/20 μ s)	$\Delta V_{1\text{mA}}/V_{1\text{mA}} \leq \pm 10\%$											
Series 20	200 A (8/20 μ s)																	
Series 32	300 A (8/20 μ s)																	
Withstanding voltage (Body insulation)	The commercial frequency voltage of AC 2.5 kV shall be applied between terminals and the bottom of the unit for one minute.																	
Mechanical	Robustness of terminations (Tensile)	After gradually applying the load of 49 N (5 kgf) and keeping the unit fixed for 10 seconds in an axial direction, the terminal shall be visually examined for any damage.	No remarkable damage															
	Vibration	After repeatedly applying a single harmonic vibration (amplitude: 0.75 mm): double amplitude: 1.5 mm with 1 minute vibration frequency cycles (10 Hz to 55 Hz to 10 Hz) to each of three perpendicular directions for 2 hours. Thereafter, the damage of the terminals is visually examined.																
Environmental	Dry heat/ High temperature storage	The specimen shall be subjected to $110 \pm 3^\circ\text{C}$ for 500 hours in a thermostatic bath without load and then stored at room temperature and humidity for one to two hours. Thereafter, the change of V_C shall be measured. <table border="1" style="margin-left: auto; margin-right: auto;"> <thead> <tr> <th>Step</th> <th>Temperature (°C)</th> <th>Period (minutes)</th> </tr> </thead> <tbody> <tr> <td>1</td> <td>-25 0 -3</td> <td>30 +3 .0</td> </tr> <tr> <td>2</td> <td>Room Temp.</td> <td>3 max.</td> </tr> <tr> <td>3</td> <td>85 +3 .0</td> <td>30 +3 .0</td> </tr> <tr> <td>4</td> <td>Room temp.</td> <td>3 max.</td> </tr> </tbody> </table>	Step	Temperature (°C)	Period (minutes)	1	-25 0 -3	30 +3 .0	2	Room Temp.	3 max.	3	85 +3 .0	30 +3 .0	4	Room temp.	3 max.	$\Delta V_{1\text{mA}}/V_{1\text{mA}} \leq \pm 5\%$
	Step	Temperature (°C)	Period (minutes)															
	1	-25 0 -3	30 +3 .0															
	2	Room Temp.	3 max.															
	3	85 +3 .0	30 +3 .0															
4	Room temp.	3 max.																
Temperature cycle	The temperature cycle shown below shall be repeated five times and then stored at room temperature and humidity for one to two hours. The change of V_C and mechanical damage shall be examined.	$\Delta V_{1\text{mA}}/V_{1\text{mA}} \leq \pm 5\%$																
Dry heat load/ High temperature load	After being continuously applied the Maximum Allowable Voltage at $85 \pm 5^\circ\text{C}$ for 500 hours, the specimen shall be stored at room temperature and humidity for one to two hours. Thereafter, the change of V_C shall be measured.	$\Delta V_{1\text{mA}}/V_{1\text{mA}} \leq \pm 10\%$																
Damp heat/Humidity (Steady state)	The specimen shall be subjected to $40 \pm 2^\circ\text{C}$, 90 to 95 %RH for 1000 hours without load and then stored at room temperature and humidity for one to two hours. Thereafter, the change of V_C shall be measured.	$\Delta V_{1\text{mA}}/V_{1\text{mA}} \leq \pm 5\%$																

Minimum quantity / Packing unit

Product	Series / Type	Part number	Minimum quantity / Packing unit	Packing quantity in carton	Carton (about) L×W×H (mm)	
"ZNR" Transient/surge absorbers	E type	General product	ERZC□□EK□□□	5	100	380×405×85
		UL and CSA recognized	ERZC□□EK□□□Y	5	100	380×405×85

Part No., quantity and country of origin are designated on outer packages in English.

※ Please contact local sales office about packing specifications.

Design and specifications are each subject to change without notice. Ask factory for the current technical specifications before purchase and/or use.
Should a safety concern arise regarding this product, please be sure to contact us immediately.

Safety and Legal Matters to Be Observed

Product specifications and applications

- Please be advised that this product and product specifications are subject to change without notice for improvement purposes. Therefore, please request and confirm the latest delivery specifications that explain the specifications in detail before the final design, or purchase or use of the product, regardless of the application. In addition, do not use this product in any way that deviates from the contents of the company's delivery specifications.
- Unless otherwise specified in this catalog or the product specifications, this product is intended for use in general electronic equipment (AV products, home appliances, commercial equipment, office equipment, information and communication equipment, etc.).
When this product is used for the following special cases, the specification document suited to each application shall be signed/sealed (with Panasonic Industry and the user) in advance..These include applications requiring special quality and reliability, wherein their failures or malfunctions may directly threaten human life or cause harm to the human body (e.g.: space/aircraft equipment, transportation/traffic equipment, combustion equipment, medical equipment, disaster prevention/crime prevention equipment, safety equipment, etc.).

Safety design and product evaluation

- Please ensure safety through protection circuits, redundant circuits, etc., in the customer's system design so that a defect in our company's product will not endanger human life or cause other serious damage.
- This catalog shows the quality and performance of individual parts. The durability of parts varies depending on the usage environment and conditions. Therefore, please ensure to evaluate and confirm the state of each part after it has been mounted in your product in the actual operating environment before use.
If you have any doubts about the safety of this product, then please notify us immediately, and be sure to conduct a technical review including the above protection circuits and redundant circuits at your company.

Laws / Regulations / Intellectual property

- The transportation of dangerous goods as designated by UN numbers, UN classifications, etc., does not apply to this product. In addition, when exporting products, product specifications, and technical information described in this catalog, please comply with the laws and regulations of the countries to which the products are exported, especially those concerning security export control.
- Each model of this product complies with the RoHS Directive (Restriction of the use of hazardous substances in electrical and electronic equipment) (2011/65/EU and (EU) 2015/863). The date of compliance with the RoHS Directive and REACH Regulation varies depending on the product model.
Further, if you are using product models in stock and are not sure whether or not they comply with the RoHS Directive or REACH Regulation, please contact us by selecting "Sales Inquiry" from the inquiry form.
- During the manufacturing process of this product and any of its components and materials to be used, Panasonic Industry does not intentionally use ozone-depleting substances stipulated in the Montreal Protocol and specific bromine-based flame retardants such as PBBs (Poly-Brominated Biphenyls) / PBDEs (Poly-Brominated Diphenyl Ethers). In addition, the materials used in this product are all listed as existing chemical substances based on the Act on the Regulation of Manufacture and Evaluation of Chemical Substances.
- With regard to the disposal of this product, please confirm the disposal method in each country and region where it is incorporated into your company's product and used.
- The technical information contained in this catalog is intended to show only typical operation and application circuit examples of this product. This catalog does not guarantee that such information does not infringe upon the intellectual property rights of Panasonic Industry or any third party, nor imply that the license of such rights has been granted.
- Design, materials, or process related to technical owned by Panasonic Industry are subject to change without notice.

Panasonic Industry will assume no liability whatsoever if the use of our company's products deviates from the contents of this catalog or does not comply with the precautions. Please be advised of these restrictions.

Matters to Be Observed When Using This Product (E / CK / SC-type)

Safety measures

An abnormal state of E-Type, CK-type, and SC-type varistors (ZNR surge absorber, hereinafter "the product" or "the surge absorber") that results from a problem with service conditions (materials used, the surrounding environment, power conditions, circuit conditions, etc.) may cause a fire accident, electric shock accident, burn accident, or product failure. Matters to note when handling this product will hereinafter be described. What is described below should be checked sufficiently before the product is used.

■ Confirming rated capabilities

Use the surge absorber within the range of its rated capabilities. Each type of surge absorber has specified rated capabilities including a maximum allowable circuit voltage, a surge current tolerance, an energy tolerance, an impulse lifespan (surge lifespan), average pulse power, and a service temperature. Using the surge absorber under severe service conditions that are beyond the rated capabilities causes degraded performance of the surge absorber or destruction of a circuit element, which may lead to smoke generation, ignition, etc.

■ Take the following measures in order to avoid an accident caused by expected phenomenon.

- (1) Destruction of the surge absorber may scatter its fractured pieces around. To protect other elements from these pieces, set product in a case or shield it with a cover.
- (2) Do not place the surge absorber near combustible materials (vinyl cable, resin mold, etc.). If avoiding the vicinity of combustible materials is difficult, protect the combustible material with an incombustible cover.
- (3) Surge absorber placed between lines
When the surge absorber is placed between lines, connect a normal type current fuse in series with the surge absorber.
* See "Current fuse" in the "Circuit design and circuit board design" section.
- (4) Surge absorber placed between a line and the ground
 - ① When the surge absorber is placed between a line and the ground, even if the surge absorber short-circuits, ground resistance will remain in the section between the line and the ground, leaving a possibility that the current fuse won't blow, in which case the outer sheath resin of the surge absorber may generate smoke or ignite due to current flow. To prevent such a case, place an earth leakage breaker in a location closer to the power supply than the surge absorber. When not using an earth leakage breaker, use a current fuse and temperature fuse in series with each other.
* See Table 1 in the "Circuit design and circuit board design" section.
 - ② When the surge absorber is placed between a live part and a metal case, it may cause electric shock if the surge absorber short-circuits. To avoid this, ground the metal case or shield it to prevent direct contact with the metal case.

■ In case the surge absorber should short-circuit and generate smoke or ignite, immediately cut off current flow to the surge absorber.

■ Rated voltage for UL certification, etc.

To allow the surge absorber to meet leak current requirements, etc., a maximum allowable circuit voltage and rated voltage are specified for the surge absorber.

When applying for UL certification, etc. of a device equipped with a surge absorber, ensure the working voltage of the device does not exceed the rated voltage of the surge absorber.

■ An unexpected sharp rise in the working voltage, an incoming excessive surge, etc., may cause the surge absorber to generate smoke or ignite.

In such a case, fire spreading through the device should be prevented to avoid expanded damage. To achieve this, take a multi-protection measure, such as adopting fire-resistant materials that make up the outer shell components and structural materials.

Use environments and cleaning conditions

- Do not use the surge absorber in an outdoor environment where the surge absorber is exposed to sunlight.
- Do not use the surge absorber in which direct sunlight hits the surge absorber or near a heating element where the temperature of the surge absorber would rise above its working temperature.
- Do not use the surge absorber in a place where the surge absorber is exposed to wind or rain or a highly humid place where steam is emitted or dew concentrates.
- Do not use the surge absorber in a place filled with dust or salt, in an atmosphere contaminated with a corrosive gas, etc., or in liquids such as water, oil, chemical, or organic solvents.

- Do not wash the surge absorber with a solvent (thinner, acetone, etc.) that damages the outer sheath resin.

Response to anomalies and handling conditions

Be careful not to drop the surge absorber on the floor, etc. The product is likely to suffer mechanical or electrical damage when dropped on the floor. Avoid using such a product.

Reliability and product life

To know the detailed specifications of individual products or specific evaluation test scores, please contact us.

Circuit design and circuit board design

Meet the following requirements. Not following the requirements can result in a shorter lifespan of the surge absorber or its failure.

- Choose a surge absorber whose maximum allowable circuit voltage has a margin relative to the maximum voltage range including source voltage fluctuations.
 - * See Table 1 in the "Circuit design and circuit board design" section.
- When surges are applied intermittently to the surge absorber at short intervals (when pulses of voltages are applied in a noise simulator test, etc.), make sure that the surge power does not exceed the maximum average pulse power of the surge absorber.
- The product numbers of recommended surge absorbers to choose are shown in Table 1.

(1) The case of placing the surge absorber between lines

When the source voltage is expected to rise temporarily due to unbalanced single-wire loads in a three-phase three-wire connection configuration, a short circuit between a voltage line and a neutral line, loss of the neutral line, or resonance of a capacitive load caused by switching on/off, use a surge absorber (varistor) indicated by "*" in Table 1.

(2) The case of placing the surge absorber between a line and the ground

Line-to-ground voltage may rise with a single-wire ground fault, etc. Use a recommended surge absorber in Table 1 that is different from the surge absorber placed between lines. When the device is subjected to an insulation resistance test (500 V DC), use a surge absorber indicated by "*" in Table 1.

According to "Electrical Appliance Technical Standards" based on the Electrical Appliance and Material Safety Act, when using a varistor voltage which would fail the insulation performance test, the surge absorber may be removed from the device when being subjected to the test, depending on circuit test conditions.

* See attached table 4, appendix 4, "Electrical Appliance Technical Standards" based on the Electrical Appliance and Material Safety Act.

When conducting a withstand voltage test (1000 V AC) of the device, remove the surge absorber from the device after getting approval from the parties concerned.

■ Current fuse

(1) Select a surge absorber and fuses to use in as shown in the following table.

Confirm that no secondary accident arises when the surge absorber in an actual circuit breaks. Selected rated currents of current fuses shown in the following table are exemplary one and may vary depending on circuit conditions used. Confirm the rated current by a test, etc., before using the current fuse.

Series	ERZC 20EK□□□(□)	ERZC 32EK□□□(□)	ERZV S34C□□□	ERZC □□CK□□□W
Current fuse (placed between lines)	10 A max.	20 A max.	20 A max.	20 A max.
Temperature fuse (placed between a line and the ground)	100 to 120°C 5A	100 to 120°C 10A	100 to 120°C 10A	100 to 120°C 10A

* Use the rated voltage of the current fuse that corresponds to the circuit voltage of a circuit including the current fuse.

* Connect a temperature fuse directly to the terminal so that heat from the terminal is easily transferred to the fuse and that the fusing element of the fuse extends along its sides.

(2) Recommended parts where fuses are connected are shown in Table 1. When a load current to a protected device is so large as to exceed the rated current of the fuse, however, connect the fuse in a location shown in the following diagram.

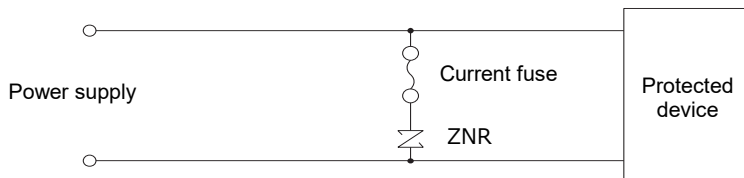

Table 1 Application example of the product (ordinary application example)

Connection	Surge absorber placed between lines	Surge absorber placed between a line and the ground																																
		<p>DC Single-phase AC</p>	<p>DC Single-phase AC</p>																															
	<p>Three-phase AC</p>	<p>Three-phase AC</p>																																
Varistor voltage selection	<table border="1"> <thead> <tr> <th rowspan="2">ZNR</th> <th rowspan="2">Power supply voltage [AC]</th> <th colspan="2">Part number</th> </tr> <tr> <th colspan="2">E, CK, SC-type</th> </tr> </thead> <tbody> <tr> <td rowspan="4">ZNR 1 ZNR 3</td> <td>100 V</td> <td></td> <td>201 to 361*</td> </tr> <tr> <td>120 V</td> <td>ERZC□□EK</td> <td>241 to 431*</td> </tr> <tr> <td>200 V to 220 V</td> <td>ERZC□□CK ERZVS34C</td> <td>471 to 621*</td> </tr> <tr> <td>240 V</td> <td></td> <td>511, 621*</td> </tr> </tbody> </table>	ZNR	Power supply voltage [AC]	Part number		E, CK, SC-type		ZNR 1 ZNR 3	100 V		201 to 361*	120 V	ERZC□□EK	241 to 431*	200 V to 220 V	ERZC□□CK ERZVS34C	471 to 621*	240 V		511, 621*	<table border="1"> <thead> <tr> <th rowspan="2">ZNR</th> <th rowspan="2">Power supply voltage [AC]</th> <th colspan="2">Part number</th> </tr> <tr> <th colspan="2">E, CK, SC-type</th> </tr> </thead> <tbody> <tr> <td rowspan="2">ZNR 2 ZNR 4</td> <td>100V to 220 V</td> <td>ERZC□□EK ERZC□□CK ERZVS34C</td> <td>471 511 821 or higher**</td> </tr> <tr> <td>240 V</td> <td></td> <td>511 821 or higher**</td> </tr> </tbody> </table> <p>* To find out about surge absorbers that can be used in an AC withstand voltage test, please contact us.</p>	ZNR	Power supply voltage [AC]	Part number		E, CK, SC-type		ZNR 2 ZNR 4	100V to 220 V	ERZC□□EK ERZC□□CK ERZVS34C	471 511 821 or higher**	240 V		511 821 or higher**
ZNR	Power supply voltage [AC]			Part number																														
		E, CK, SC-type																																
ZNR 1 ZNR 3	100 V		201 to 361*																															
	120 V	ERZC□□EK	241 to 431*																															
	200 V to 220 V	ERZC□□CK ERZVS34C	471 to 621*																															
	240 V		511, 621*																															
ZNR	Power supply voltage [AC]	Part number																																
		E, CK, SC-type																																
ZNR 2 ZNR 4	100V to 220 V	ERZC□□EK ERZC□□CK ERZVS34C	471 511 821 or higher**																															
	240 V		511 821 or higher**																															

Processing conditions

- Do not apply vibration, impact (drop impact, etc.), or pressure strong enough to crack the outer sheath resin or absorber body of the surge absorber.
- When coating the surge absorber with a resin or embedding it in a resin mold, avoid using a resin that degrades the surge absorber.
- Do not bend the surge absorber or apply force thereto close to the insulation cover of the lead terminal.
- Make the wire as short and straight as possible.

Mounting and storage conditions

- Do not melt solder or the insulation material making up the surge absorber when soldering the lead terminal.
- Do not keep the product in a high-temperature or high-humidity condition. Keep the surge absorber in a room with a temperature of 40 °C or lower and a relative humidity of 75% or lower and use the surge absorber within two years of storage.
- Keep the surge absorber in a place where no corrosive gas atmosphere (hydrogen sulfide, sulfurous acid, chlorine, ammonia, etc.) is present.
- Keep the surge absorber in a place where the surge absorber is protected from direct sunlight, dew concentration, etc.