

Amplifier-separated

Slim Body Automatic Sensitivity Setting Photoelectric Sensor

SU-7 SERIES SH SERIES

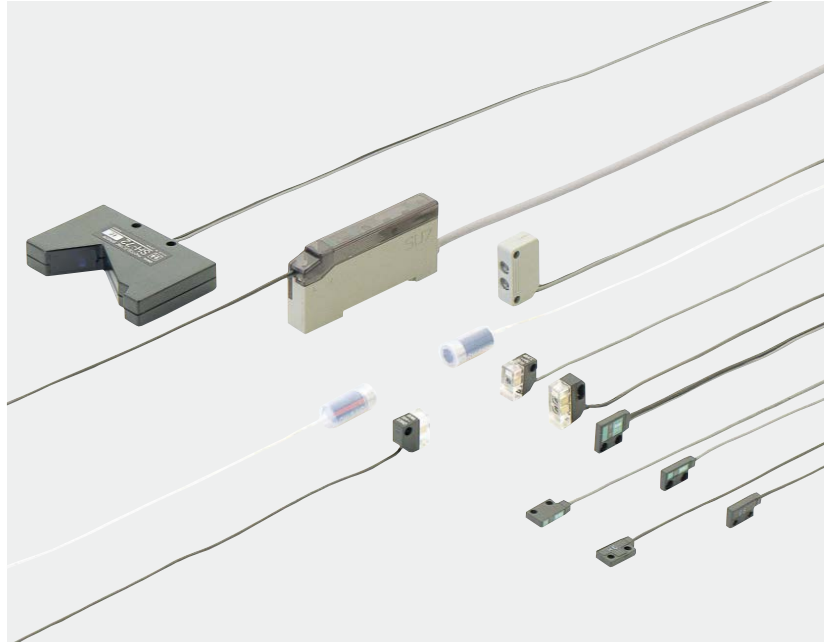
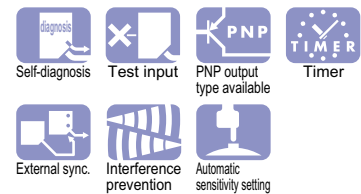
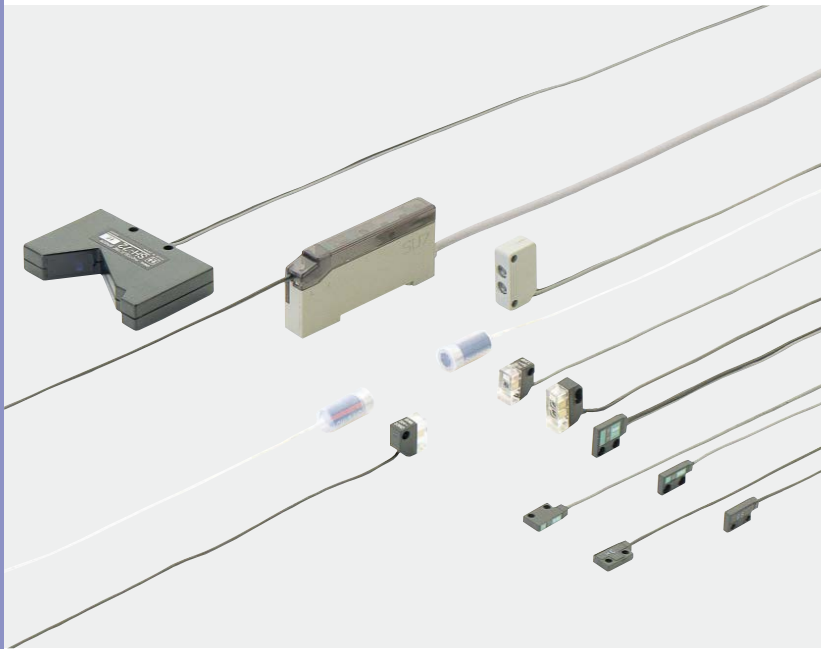

SU-7 SERIES **SH** SERIES**Simple and compact design****Simple automatic sensitivity setting**

Anyone can carry out the optimum sensitivity setting by simply pressing two buttons.

- ① Aligning with the mark to be detected, press the "ON" button. ② Aligning with the background, press the "OFF" button.

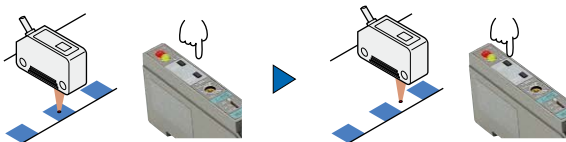
**MOUNTING / SIZE**

Thickness: 10 mm 0.394 in

Installation space can be greatly reduced as the **SU-7** amplifier is just 10 mm **0.394 in** thick.
(W10 × H31.5 × D67 mm **W0.394 × H1.240 × D2.638 in**)

ENVIRONMENTAL RESISTANCE**Chemical resistant type****SH-61R****Strong against chemicals**

Since the sensor heads and the attached cables are covered by fluorine resin, **SH-61R** can be used in a harsh chemical environment.

Moreover, it has a long sensing range of 2.5 m **8.202 ft**.

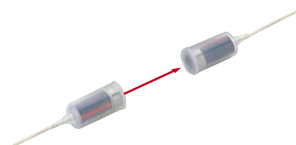

Long sensing range
2.5 m **8.202 ft**

Quick wire connection

A snap of the lever secures the connection of the sensor head cables on the **SU-7** amplifier. It is no longer required to strip the wire insulation. Further, the exclusive stripper (accessory) can be used to easily peel off the sensor cable outer sheath.

- ① Strip the cable sheaths with the exclusive stripper. ② Insert the wires into the holes. ③ Flip up and lock the lever.

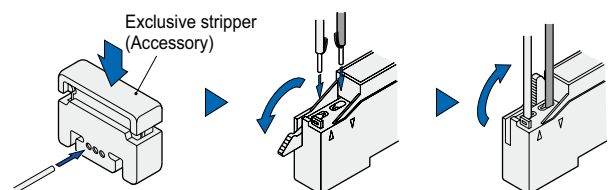

Caution: The outer fluorine sheath of the chemical resistant type sensor head, **SH-61R**, cannot be cut off with the exclusive stripper.

FUNCTIONS**Nine advanced functions for versatile sensing**

- ① **Limit sensitivity setting** **All models**
Sensitivity for detection of minute differences can be set by the push of one button without the presence of an object.
- ② **Sensitivity shift** **All models**
The set threshold level can be shifted from the center towards either ON or OFF level.
- ③ **Remote sensitivity selection** **SU-79**
The amplifier stores four channels of sensitivity levels. They can be selected by the remote inputs.
- ④ **Remote sensitivity setting** **SU-77**
The sensitivity level can be adjusted from a remote place.
- ⑤ **External synchronization** **SU-75**
The timing for sensing can be specified by an external input.
- ⑥ **Test input (emission halt)** **SU-75**
Convenient for start-up inspection.
- ⑦ **Sensitivity margin indication** **All models**
The number of blinks of the stability indicator indicates the degree of the sensitivity margin.
- ⑧ **ON-delay/OFF-delay timer** **SU-7 SU-77 SU-79 SU-7J**
The timer can be selected for either ON-delay or OFF-delay of 0 to 5 sec.
- ⑨ **Interference prevention** **All models**
Two sensor heads can be mounted close together.

Refer to "PRECAUTIONS FOR PROPER USE (p.12~)" for further details.

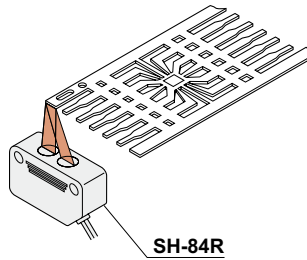
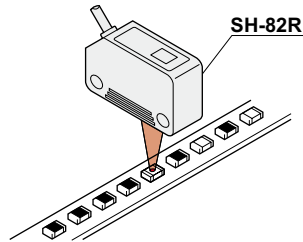
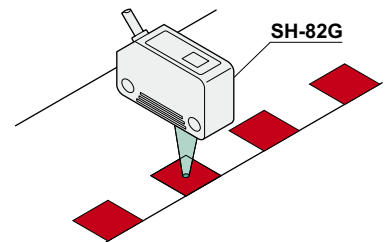
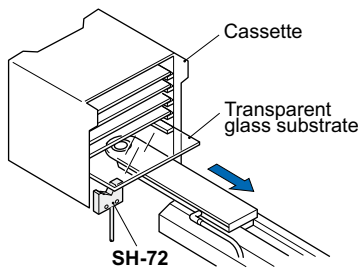
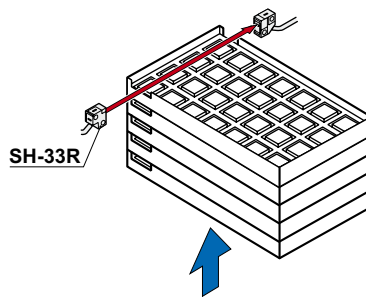
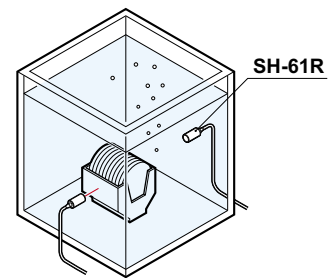
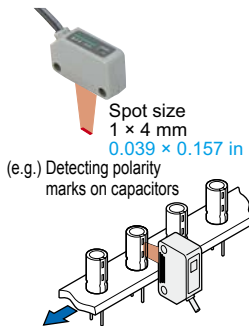
APPLICATIONS**Positioning of a lead frame****Identifying top face from bottom face of chip components****Detecting red mark on white paper****Detecting transparent glass substrates in cassette****Detecting IC height****Detecting wafer cassette in quartz tank containing cleaning liquid****VARIETIES****Line-focus type****SH-84R****Suitable for detecting printed characters**

It can be used to detect printed characters because of its line shaped projected area of 1 × 4 mm 0.039 × 0.157 in.

Strong against position deviation

Since it makes a judgment based upon the total light incident on the sensing area, it is not easily affected by a deviation in sensing object position.

Glass substrate detection type**SH-72****Reliable glass substrate detection**

Its unique optical system enables detection of transparent glass plate, as well as, specular film deposited glass plate at the same distance.

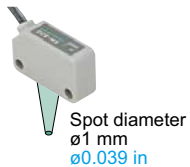
No dead zone**Repeatability: 0.03 mm 0.001 in****Not affected by background****Pinpoint type with green LED beam****SH-82G****Red/white color discrimination**

Discrimination between red/white, red/yellow or red/orange, which is difficult with the red LED type, is easy with SH-82G.

Pinpoint type with red LED beam**SH-82R****Suitable for tiny object sensing****Spot diameter: ø0.7 mm ø0.028 in**

Top/bottom face of a chip component can be easily discriminated.

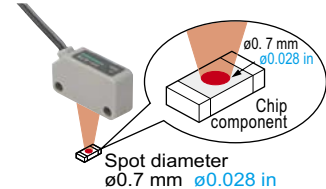
**Ultra-slim type****SH-2□****Compact size: 0.3 cm³****Thickness: 3 mm 0.118 in****Versatile mounting**

Diffuse reflective type sensor head

- Front sensing

Thru-beam type sensor head

- Front sensing

- Side sensing





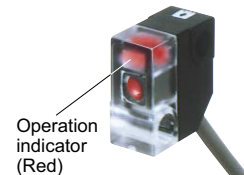



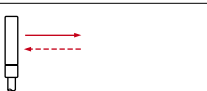

**Ultra-small type****SH-3□****Sensor head with indicator**

An operation indicator, which enables an easy checking of the operation at site, has been incorporated.

**2 m 6.562 ft long sensing range with red LED beam (SH-33R)**

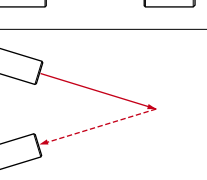
Visible red LED beam makes alignment easy.

ORDER GUIDE**Sensor heads**

Type		Appearance	Sensing range	Model No. (Note)	Emitting element	Operation indicator
Ultra-slim type	Thru-beam	Front sensing	 300 mm 11.811 in	SH-21	Infrared LED	—
		Side sensing				
	Diffuse reflective Front sensing	 50 mm 1.969 in	SH-22			
Ultra-small type	Thru-beam		1 m 3.281 ft	SH-31R	Red LED	—
			100 mm 3.937 in	SH-31G	Green LED	
			2 m 6.562 ft	SH-33R	Red LED	
	Diffuse reflective	 100 mm 3.937 in	SH-32R	Red LED		
Chemical resistant type	Thru-beam	 2.5 m 8.202 ft	SH-61R	Red LED	Incorporated	
	Convergent reflective (Using optional mounting bracket MS-SH6-2)	 5 to 80 mm 0.197 to 3.150 in (Convergent point: 25 mm 0.984 in)				
Mark sensor	Pinpoint		10 to 14 mm 0.394 to 0.551 in (Convergent point: 12 mm 0.472 in) (Spot diameter: ø0.7 mm ø0.028 in)	SH-82R	Red LED	
			10 to 14 mm 0.394 to 0.551 in (Convergent point: 12 mm 0.472 in) (Spot diameter: ø1 mm ø0.039 in)	SH-82G	Green LED	
	Line-focus	 17 to 23 mm 0.669 to 0.906 in (Convergent point: 20 mm 0.787 in) (Spot size: 1 × 4 mm 0.039 × 0.157 in)	SH-84R	Red LED		
Glass substrate detection sensor	 0.5 to 7.5 mm 0.020 to 0.295 in (with transparent glass substrate)	SH-72	Infrared LED	—		

Note: The model No. with "P" shown on the label affixed to the thru-beam type sensor is the emitter, "D" shown on the label is the receiver.

Amplifiers

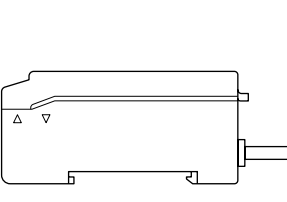
Type	Appearance	Model No.	Functions (○: Incorporated)									
			Automatic sensitivity setting	Sensitivity shift	Limit sensitivity setting	Remote sensitivity setting	Remote sensitivity selection	Sensitivity margin indication	External synchronization	Test input (emission halt)	Timer	Interference prevention
Standard type		SU-7	○	○	○	—	—	○	—	—	○	○
		SU-7J	○	○	○	—	—	○	—	—	○	○
		SU-7P	○	○	○	—	—	○	—	—	○	○
External synchronization input type		SU-75	○	○	○	—	—	○	○	○	—	○
Remote sensitivity adjustment type		SU-77	○	○	○	○	—	○	—	—	○	○
Remote sensitivity selection type		SU-79	○	○	○	—	○	○	—	—	○	○

ORDER GUIDE

Plug-in connector type

It is usable with the sensor & wire-saving link system **S-LINK**, sensor block for simple wiring **SL-BMW** or **SL-BW**, or with connector attached cable **CN-54-C2** or **CN-54-C5**.

SU-7J

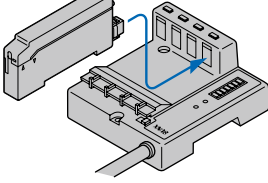

Sensor & wire-saving link system
S-LINK

SU-7J

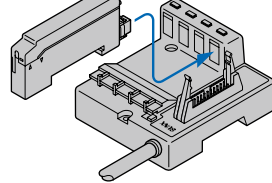

Sensor block for simple wiring
SL-BMW, SL-BW

SU-7J

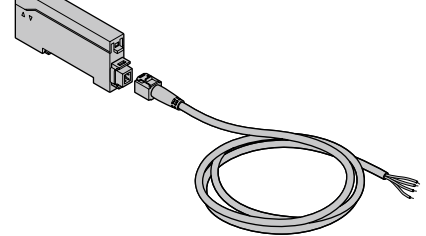

Connector attached cable
CN-54-C2 (2 m **6.562 ft** long)
CN-54-C5 (5 m **16.404 ft** long)

Accessories

- **MS-DIN-2**
(Amplifier mounting bracket)

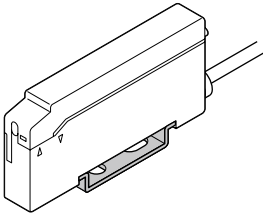

- **SU-CT1**
(Exclusive stripper)

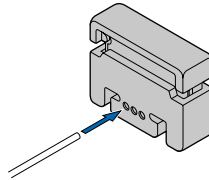

- **MS-SH6-1**
(Sensor head mounting bracket for **SH-61R**)

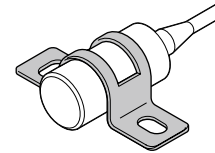

OPTIONS

Designation	Model No.	Description																															
Slit mask (For SH-31R , SH-31G and SH-33R only)	OS-SS3	This is a convenient slit mask having four types of slit masks.																															
		<table border="1"> <thead> <tr> <th rowspan="2">Slit size</th> <th rowspan="2">Fitting</th> <th colspan="3">Sensing range</th> <th rowspan="2">Min. sensing object</th> </tr> <tr> <th>SH-31R</th> <th>SH-31G</th> <th>SH-33R</th> </tr> </thead> <tbody> <tr> <td rowspan="2">0.5 × 3 mm 0.020 × 0.118 in</td> <td>One side</td> <td>500 mm 19.685 in</td> <td>50 mm 1.969 in</td> <td>750 mm 29.528 in</td> <td>ø3 mm ø0.118 in</td> </tr> <tr> <td>Both sides</td> <td>250 mm 9.843 in</td> <td>25 mm 0.984 in</td> <td>400 mm 15.748 in</td> <td>0.5 × 3 mm 0.020 × 0.118 in</td> </tr> <tr> <td rowspan="2">1 × 3 mm 0.039 × 0.118 in</td> <td>One side</td> <td>700 mm 27.559 in</td> <td>70 mm 2.756 in</td> <td>1,000 mm 39.370 in</td> <td>ø3 mm ø0.118 in</td> </tr> <tr> <td>Both sides</td> <td>500 mm 19.685 in</td> <td>50 mm 1.969 in</td> <td>750 mm 29.528 in</td> <td>1 × 3 mm 0.039 × 0.118 in</td> </tr> </tbody> </table>	Slit size	Fitting	Sensing range			Min. sensing object	SH-31R	SH-31G	SH-33R	0.5 × 3 mm 0.020 × 0.118 in	One side	500 mm 19.685 in	50 mm 1.969 in	750 mm 29.528 in	ø3 mm ø0.118 in	Both sides	250 mm 9.843 in	25 mm 0.984 in	400 mm 15.748 in	0.5 × 3 mm 0.020 × 0.118 in	1 × 3 mm 0.039 × 0.118 in	One side	700 mm 27.559 in	70 mm 2.756 in	1,000 mm 39.370 in	ø3 mm ø0.118 in	Both sides	500 mm 19.685 in	50 mm 1.969 in	750 mm 29.528 in	1 × 3 mm 0.039 × 0.118 in
		Slit size			Fitting	Sensing range			Min. sensing object																								
			SH-31R	SH-31G		SH-33R																											
0.5 × 3 mm 0.020 × 0.118 in	One side	500 mm 19.685 in	50 mm 1.969 in	750 mm 29.528 in	ø3 mm ø0.118 in																												
	Both sides	250 mm 9.843 in	25 mm 0.984 in	400 mm 15.748 in	0.5 × 3 mm 0.020 × 0.118 in																												
1 × 3 mm 0.039 × 0.118 in	One side	700 mm 27.559 in	70 mm 2.756 in	1,000 mm 39.370 in	ø3 mm ø0.118 in																												
	Both sides	500 mm 19.685 in	50 mm 1.969 in	750 mm 29.528 in	1 × 3 mm 0.039 × 0.118 in																												
Sensor head mounting bracket (For the ultra-small type only)	MS-SS3-1	Mounting bracket for the ultra-small sensor head (The thru-beam type sensor head needs two brackets)																															
Sensor head mounting bracket (For the mark sensor only)	MS-DS-1	Mounting bracket for the mark sensor head																															
Sensor head mounting bracket (For SH-61R only)	MS-SH6-2	The emitter and the receiver are fixed together at an angle for use as a convergent reflective type sensor.																															
Sensor checker	CHX-SC2	It is useful for beam alignment of thru-beam type sensors. The optimum receiver position is given by indicators, as well as an audio signal.																															

Slit mask

- **OS-SS3**

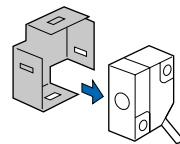

The sensor head and the slit mask are mounted together.

Sensor head mounting bracket

- **MS-SS3-1**

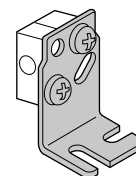

Two M3 (length 12 mm
0.472 in) screws with washers are attached.

- **MS-DS-1**

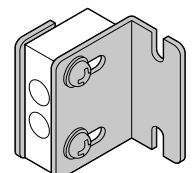

Two M3 (length 14 mm
0.551 in) screws with washers are attached.

- **MS-SH6-2**

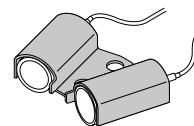

No screw is attached.

Sensor checker

- **CHX-SC2**

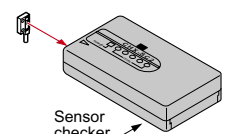

Sensor checker

SPECIFICATIONS

Sensor heads

Item	Model No.	Ultra-slim type			Ultra-small type			
		Thru-beam		Diffuse reflective	Thru-beam			Diffuse reflective
		Front sensing	Side sensing		Red LED	Green LED	Red LED	
		SH-21	SH-21E	SH-22	SH-31R	SH-31G	SH-33R	SH-32R
CE marking directive compliance		—————			EMC Directive, RoHS Directive			
Applicable amplifiers		SU-7 series						
Sensing range		300 mm 11.811 in		50 mm 1.969 in (Note 2)	1 m 3.281 ft	100 mm 3.937 in	2 m 6.562 ft	100 mm 3.937 in (Note 2)
Sensing object		Min. \varnothing 0.3 mm \varnothing0.012 in opaque object (under the optimum condition) (Note 4)		Min. \varnothing 0.3 mm \varnothing0.012 in copper wire (with 3 mm 0.118 in setting distance and at the max sensitivity)	Min. \varnothing 1 mm \varnothing0.039 in opaque object (with 1 m 3.281 ft setting distance and at the optimum sensitivity (Note 5))	Min. \varnothing 1 mm \varnothing0.039 in opaque object (with 100 mm 3.937 in setting distance and at the optimum sensitivity (Note 5))	Min. \varnothing 1 mm \varnothing0.039 in opaque object (with 2 m 6.562 ft setting distance and at the optimum sensitivity (Note 5))	Opaque, translucent or transparent object (Note 3)
Hysteresis		—————		15 % or less of operation distance (Note 2)	—————			15 % or less of operation distance (Note 2)
Repeatability (perpendicular to sensing axis)		0.03 mm 0.001 in or less		0.15 mm 0.006 in or less	0.1 mm 0.004 in or less			0.5 mm 0.020 in or less
Operation indicator		—————			Red LED (lights up when the sensing output of the amplifier is ON, incorporated on the emitter of the thru-beam type sensor head)			
Environmental resistance	Pollution degree	—————			3 (Industrial environment)			
	Protection	IP62 (IEC)			IP66 (IEC)			
	Ambient temperature	-10 to +60 °C +14 to 140 °F (No dew condensation or icing allowed) Storage: -20 to +70 °C -4 to +158 °F			-25 to +60 °C -13 to +140 °F (No dew condensation or icing allowed) Storage: -30 to +70 °C -22 to +158 °F			
	Ambient humidity	35 to 85 % RH, Storage: 35 to 85 % RH						
	Ambient illuminance	Incandescent light: 3,500 lx or less at the light-receiving face						
	Vibration resistance	10 to 55 Hz frequency, 1.5 mm 0.059 in double amplitude in X, Y and Z directions for two hours each						
	Shock resistance	500 m/s ² acceleration (50 G approx.) in X, Y and Z directions three times each						
Emitting element		Infrared LED (modulated)			Red LED (modulated)	Green LED (modulated)	Red LED (modulated)	
Peak emission wavelength		880 nm 0.035 mil			700 nm 0.028 mil	570 nm 0.022 mil	680 nm 0.027 mil	700 nm 0.028 mil
Material		Enclosure: Polycarbonate (glass fiber reinforced)			Enclosure: ABS, Lens: Polycarbonate			
Cable		0.089 mm ² (ultra-slim type: 0.057 mm ²) single core (diffuse reflective type: two parallel single core wires) shielded cable, 3 m 9.843 ft long						
Cable extension		Extension up to total 5 m 16.404 ft (ultra-small type: 10 m 32.808 ft) is possible with an equivalent cable (thru-beam type: both emitter and receiver).						
Net weight		Emitter: 12 g approx. Receiver: 12 g approx.		24 g approx.	Emitter: 10 g approx. Receiver: 10 g approx.			20 g approx.
Accessory		Sensor head mounting screw: 2 sets (SH-22 : 1 set)			—————			

Notes: 1) Where measurement conditions have not been specified precisely, the conditions used were an ambient temperature of +23 °C **+73.4 °F**.

2) The sensing range and the hysteresis of the diffuse reflective type sensor are specified for white non-glossy paper (50 × 50 mm **1.969 × 1.969 in**) as the object.

3) Make sure to confirm detection with an actual sensor before use.

4) The optimum condition is the condition when the sensitivity is adjusted so that the operation indicator just lights up at the given distance in the light received condition.

5) The optimum sensitivity stands for the sensitivity level when the operation indicator just lights up in the light received condition.

SPECIFICATIONS

Sensor heads

Type	Chemical resistant type	Mark sensor			Glass substrate detection sensor	
	Thru-beam	Pinpoint		Line-focus		
Item	Model No.	SH-61R	SH-82R	SH-82G	SH-84R	SH-72
Applicable amplifiers		SU-7 series				
Sensing range	2.5 m 8.202 ft (5 to 80 mm 0.197 to 3.150 in when mounted on optional mounting bracket (MS-SH6-2) and used as convergent reflective type (Conv. point: 25 mm 0.984 in) (Note 3))	10 to 14 mm 0.394 to 0.551 in (Convergent point: 12 mm 0.472 in) (Spot diameter: ϕ 0.7 mm ϕ0.028 in) (Note 2)	10 to 14 mm 0.394 to 0.551 in (Convergent point: 12 mm 0.472 in) (Spot diameter: ϕ 1 mm ϕ0.039 in) (Note 2)	17 to 23 mm 0.669 to 0.906 in (Convergent point: 20 mm 0.787 in) (Spot size: 1 × 4 mm 0.039 × 0.157 in) (Note 2)	0.5 to 7.5 mm 0.020 to 0.295 in (with transparent glass plate)	
Sensing object	Min. ϕ 5 mm ϕ0.197 in opaque object (Min. ϕ 1 mm ϕ0.039 in steel wire when mounted on optional mounting bracket (MS-SH6-2) and used as convergent reflective type with 25 mm 0.984 in setting distance and at the max. sensitivity)	Min. 0.07 mm 0.003 in width black line on white paper (with 12 mm 0.472 in setting distance and at the optimum sensitivity) (Note 5)	Min. 0.2 mm 0.008 in width black line on white paper (with 12 mm 0.472 in setting distance and at the optimum sensitivity) (Note 5)	Min. 0.07 mm 0.003 in width black line on white paper (Note 6) (with 20 mm 0.787 in setting distance and at the optimum sensitivity) (Note 5)	\square 24 mm \square 0.945 in or more transparent glass, aluminum-evaporated mirror, etc. (Note 4)	
Hysteresis	(15 % or less of operation distance when mounted on optional mounting bracket (MS-SH6-2) and used as convergent reflective type. (Note 3))	10 % or less of operation distance (Note 2)			5 % or less of operation distance	
Repeatability (perpendicular to sensing axis)	0.1 mm 0.004 in or less (0.1 mm 0.004 in or less of operation distance when mounted on optional mounting bracket (MS-SH6-2) and used as convergent reflective type. (with 25 mm 0.984 in setting distance and at the optimum sensitivity (Note 5))	0.02 mm 0.0008 in or less	0.03 mm 0.001 in or less	0.03 mm 0.001 in or less (Note 7)	0.03 mm 0.001 in or less (along sensing axis)	
Operation indicator	Orange LED (lights up when the sensing output of the amplifier is ON, incorporated on the emitter)	Red LED (lights up when the sensing output of the amplifier is ON)			—	
Environmental resistance	Protection	IP67 (IEC)				
	Ambient temperature	-10 to +55 °C +14 to +131 °F (No dew condensation or icing allowed), Storage: -20 to +70 °C -4 to +158 °F				-10 to +60 °C +14 to +140 °F (No dew condensation or icing allowed) Storage: -10 to +60 °C +14 to +140 °F
	Ambient humidity	35 to 85 % RH, Storage: 35 to 85 % RH				
	Ambient illuminance	Incandescent light: 3,500 lx or less (SH-61R: 2,000 lx or less) at the light-receiving face				
	Vibration resistance	10 to 500 Hz frequency, 3 mm 0.118 in double amplitude (SH-72: 10 to 55 Hz frequency, 1.5 mm 0.059 in amplitude) in X, Y and Z directions for two hours each				
Shock resistance	500 m/s ² acceleration (50 G approx.) in X, Y and Z directions three times each					
Emitting element	Red LED (modulated)		Green LED (modulated)	Red LED (modulated)	Infrared LED (modulated)	
Peak emission wavelength	644 nm 0.025 mil	680 nm 0.027 mil	570 nm 0.022 mil	680 nm 0.027 mil	880 nm 0.035 mil	
Material	Enclosure: Fluorine resin Cable sheath: Fluorine resin	Enclosure: Polycarbonate, Lens: Acrylic			Enclosure: Polycarbonate	
Cable	0.089 mm ² single core, two parallel (SH-61R: 0.089 mm ² single core) shielded cables, 2 m 6.562 ft long (SH-72: 3 m 9.843 ft long)					
Cable extension	Extension up to total 5 m 16.404 ft is possible with an equivalent cable (SH-61R: both emitter and receiver).					
Net weight	Emitter: 15 g approx. Receiver: 15 g approx.	20 g approx.			25 g approx.	
Accessory	MS-SH6-1 (Sensor head mounting bracket): 2 pcs.					

- Notes: 1) Where measurement conditions have not been specified precisely, the conditions used were an ambient temperature of +23 °C +73.4 °F.
 2) The sensing range and the hysteresis of the mark sensor are specified for white non-glossy paper (50 × 50 mm **1.969 × 1.969 in**) as the object.
 3) The sensing range and the hysteresis for the chemical resistant type sensor used in the convergent reflective mode is specified for white non-glossy paper (150 × 150 mm **5.906 × 5.906 in**) as the object.
 4) Make sure to confirm detection with an actual sensor before use.
 5) The optimum sensitivity stands for the sensitivity level when the operation indicator just lights up in the light received condition.

- 6) The minimum sensing object for **SH-84R** is specified for the case when the sensor detects a black line with respect to the spot as shown below.

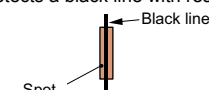

- 7) The repeatability for **SH-84R** is specified for the case when the sensing object approaches the spot sideways as shown below (0.12 mm **0.005 in** if it approaches from above or below).

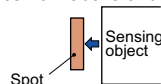

SPECIFICATIONS

Amplifiers

Item	Model No. (Note 2)	Type	Standard type	External synchronization input type	Remote sensitivity setting type	Remote sensitivity selection type	
		NPN output	SU-7(J)	SU-75	SU-77	SU-79	
		PNP output	SU-7P	—————	—————	—————	
Applicable sensor heads		SH series					
Supply voltage		12 to 24 V DC $\pm 10\%$ Ripple P-P 10 % or less					
Current consumption		35 mA or less					
Sensing output		<NPN output type> NPN open-collector transistor			<PNP output type> PNP open-collector transistor		
		<ul style="list-style-type: none"> Maximum sink current: 100 mA Applied voltage: 30 V DC or less (between sensing output and 0 V) Residual voltage: 1.0 V or less (at 100 mA sink current) 0.4 V or less (at 16 mA sink current) 			<ul style="list-style-type: none"> Maximum source current: 100 mA Applied voltage: 30 V DC or less (between sensing output and +V) Residual voltage: 2.0 V or less (at 100 mA source current) 1.0 V or less (at 16 mA source current) 		
		Utilization category		DC-12 or DC-13			
		Output operation		Selectable either Light-ON or Dark-ON with the ON and OFF buttons (Selectable with the external inputs for SU-77)			
Short-circuit protection		Incorporated					
Self-diagnosis output		<NPN output type> NPN open-collector transistor			<PNP output type> PNP open-collector transistor		
		<ul style="list-style-type: none"> Maximum sink current: 50 mA Applied voltage: 30 V DC or less (between self-diagnosis output and 0 V) Residual voltage: 1.0 V or less (at 50 mA sink current) 0.4 V or less (at 16 mA sink current) 			<ul style="list-style-type: none"> Maximum source current: 50 mA Applied voltage: 30 V DC or less (between self-diagnosis output and +V) Residual voltage: 2.0 V or less (at 50 mA source current) 1.0 V or less (at 16 mA source current) 		
		Output operation		ON under unstable sensing condition (restored automatically after 40 ms approx.), or if the sensing output is short-circuited (restored when short-circuit is rectified). (For the remote sensitivity adjustment type, it turns ON for 40 ms approx. Also after the remote sensitivity input is received.)			
Short-circuit protection		—————					
Response time		0.6 ms or less (0.8 ms or less when the interference prevention function is used)					
Operation indicator		Red LED (lights up when the sensing output is ON)					
Stability indicator		Green LED (<ul style="list-style-type: none"> "RUN" mode: Lights up under stable light received condition or stable dark condition "SET" mode: At the time of sensitivity setting, blinks twice when the difference between ON and OFF levels is greater than the hysteresis, but blinks 15 times when it is equal to or less than the hysteresis. Also blinks twice after the interference prevention is set "SET" mode → When "SIF" or "RUN" mode is selected: Blinks from 0 to 5 times according to the sensitivity margin)					
Test input (emission halt) function		—————	Incorporated		—————	—————	
External synchronization function		—————	Incorporated (Either gate or edge trigger is selectable)		—————	—————	
Remote sensitivity setting function		—————	—————	Incorporated		—————	
Remote sensitivity selection function		—————	—————	—————	Incorporated (Stores four sensitivities)		
Sensitivity shift & limit sensitivity setting functions		Shifts the set sensitivity level					
Interference prevention function		Incorporated					
Timer function		ON-delay/OFF-delay timer (variable 0 to 5 sec.)	—————	ON-delay/OFF-delay timer (variable 0 to 5 sec.)			
Environmental resistance	Pollution degree		3 (Industrial environment)				
	Ambient temperature		-10 to +55 °C +14 to +131 °F (No dew condensation or icing allowed), Storage: -20 to +70 °C -4 to +158 °F				
	Ambient humidity		35 to 85 % RH, Storage: 35 to 85 % RH				
	Voltage withstandability		1,000 V AC for one min. between all supply terminals connected together and enclosure				
	Insulation resistance		20 M Ω , or more, with 250 V DC megger between all supply terminals connected together and enclosure				
	Vibration resistance		10 to 150 Hz frequency, 0.75 mm 0.030 in double amplitude in X, Y and Z directions for two hours each				
	Shock resistance		100 m/s ² acceleration (10 G approx.) in X, Y and Z directions five times each				
Material		Enclosure: Heat-resistant ABS, Case cover: Polycarbonate, Cable lock lever: PPS					
Cable		0.15 mm ² 6-core (SU-7 and SU-7P : 0.2 mm ² 4-core) cabtyre cable, 2 m 6.562 ft long (excluding SU-7J)					
Cable extension		Extension up to total 100 m 328.084 ft is possible with 0.3 mm ² , or more, cable.					
Weight		Net weight: 65 g approx.					
Accessories		MS-DIN-2 (Amplifier mounting bracket): 1 pc., SU-CT1 (Stripper): 1 pc.					

Notes: 1) Where measurement conditions have not been specified precisely, the conditions used were an ambient temperature of +23 °C +73.4 °F.

2) **SU-7J** is plug-in connector type.

I/O CIRCUIT AND WIRING DIAGRAMS

SU-7 SU-7J

Standard type/NPN output

I/O circuit diagram

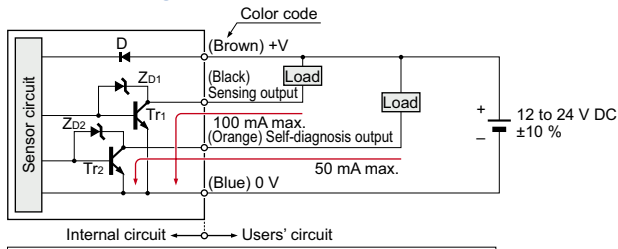

Symbols ... D: Reverse supply polarity protection diode
ZD1, ZD2: Surge absorption zener diode
Tr1, Tr2 : NPN output transistor

Wiring diagram

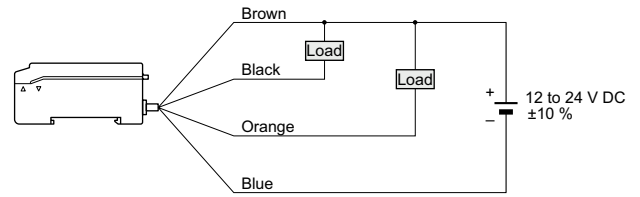

SU-75

External synchronization input type

I/O circuit diagram

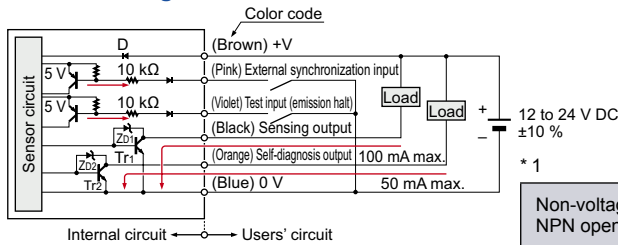

Symbols ... D: Reverse supply polarity protection diode
ZD1, ZD2: Surge absorption zener diode
Tr1, Tr2 : NPN output transistor

Wiring diagram

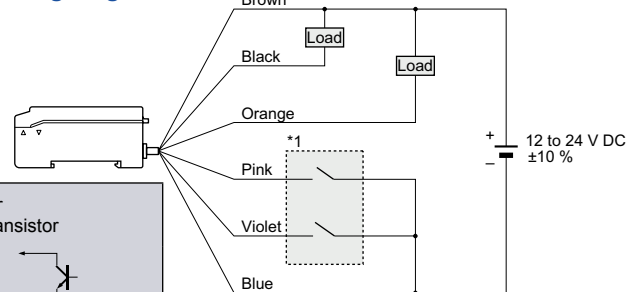

Non-voltage contact or NPN open-collector transistor

External synchronization input/test input.
Low: 0 to 1 V
High: 4.5 to 30 V, or open

SU-77

Remote sensitivity setting type

I/O circuit diagram

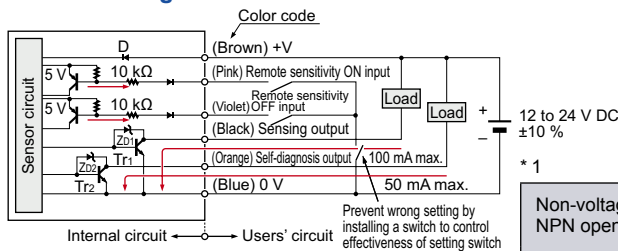

Symbols ... D: Reverse supply polarity protection diode
ZD1, ZD2: Surge absorption zener diode
Tr1, Tr2 : NPN output transistor

Wiring diagram

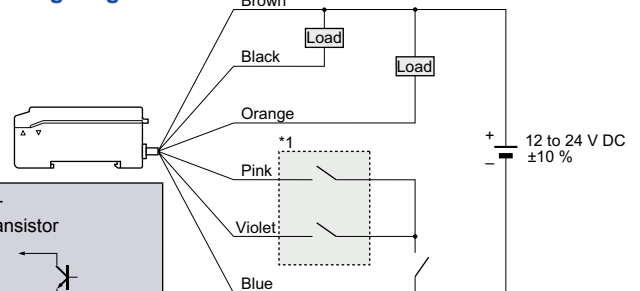

Non-voltage contact or NPN open-collector transistor

Remote sensitivity ON input/OFF input.
Low: 0 to 1 V
High: 4.5 to 30 V, or open

SU-79

Remote sensitivity selection type

I/O circuit diagram

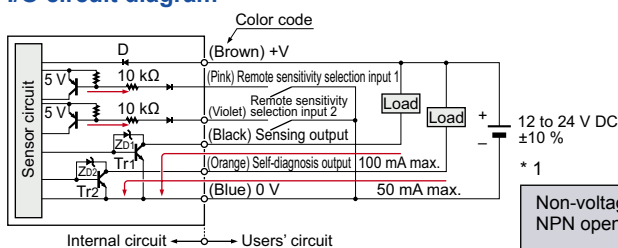

Symbols ... D: Reverse supply polarity protection diode
ZD1, ZD2: Surge absorption zener diode
Tr1, Tr2 : NPN output transistor

Wiring diagram

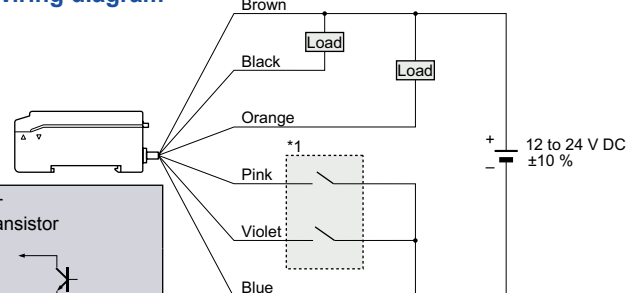

Non-voltage contact or NPN open-collector transistor

Remote sensitivity selection input 1/2
Low: 0 to 1 V
High: 4.5 to 30 V, or open

I/O CIRCUIT AND WIRING DIAGRAMS

SU-7P

Standard type/PNP output

I/O circuit diagram

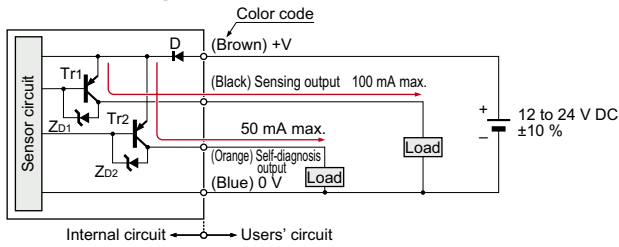

Wiring diagram

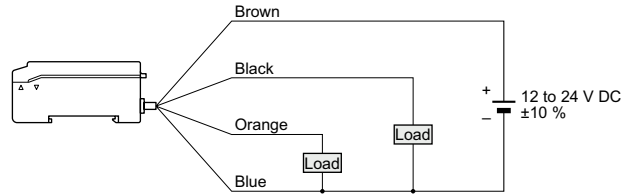

Symbols ... D: Reverse supply polarity protection diode
ZD1, ZD2: Surge absorption zener diode
Tr1, Tr2 : PNP output transistor

SENSING CHARACTERISTICS (TYPICAL)

SH-21 SH-21E Thru-beam type

Parallel deviation

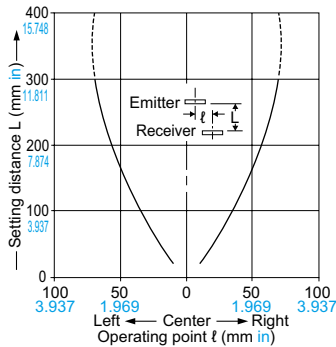

SH-31R Thru-beam type

Parallel deviation

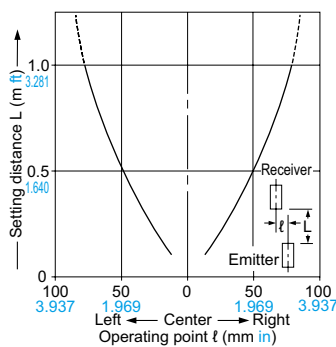

SH-31G Thru-beam type

Parallel deviation

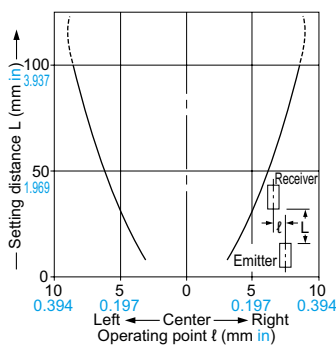

SH-33R Thru-beam type

Parallel deviation

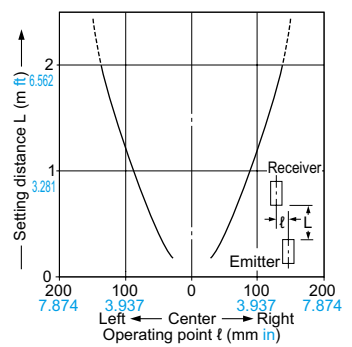

SH-22 Diffuse reflective type

Sensing field

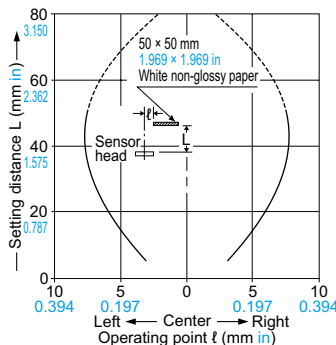

SH-32R Diffuse reflective type

Sensing field

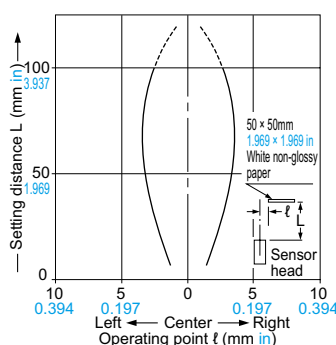

Correlation between sensing object size and sensing range

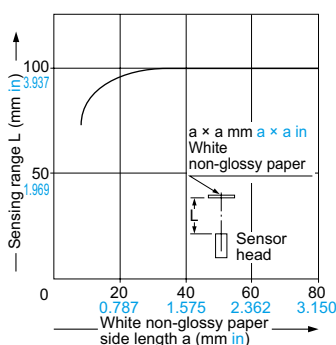

As the sensing object size becomes smaller than the standard size (white non-glossy paper 50 × 50 mm 1.969 × 1.969 in), the sensing range shortens, as shown in the left graph.

(For plotting the left graph, the sensitivity has been set such that a 50 × 50 mm 1.969 × 1.969 in white non-glossy paper is just detectable at a distance of 100 mm 3.937 in.)

SH-72 Glass substrate detection sensor

Sensing field

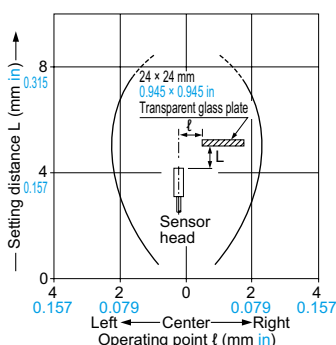

SH-82R Mark sensor

Sensing field

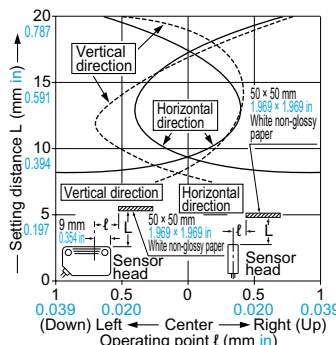

SH-82G Mark sensor

Sensing field

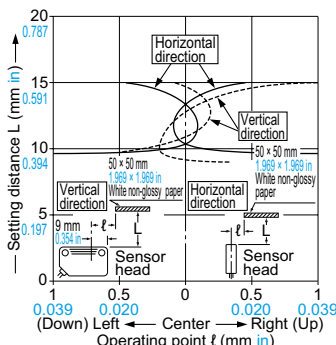

SH-84R Mark sensor

Sensing field

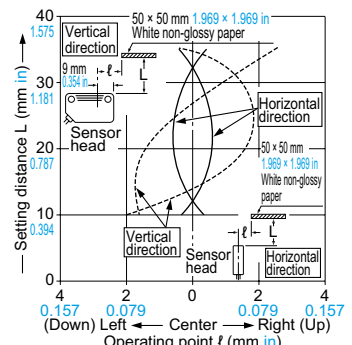

SENSING CHARACTERISTICS (TYPICAL)

SH-61R

Chemical resistant type

Parallel deviation

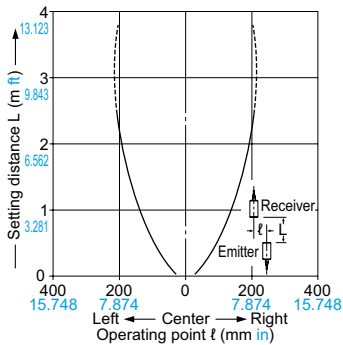

Sensing field with optional mounting bracket (MS-SH6-2)

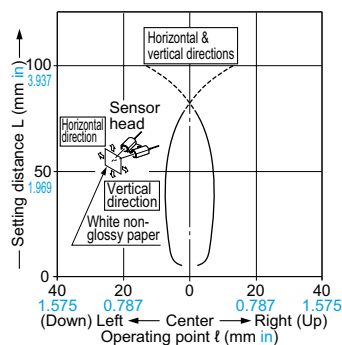

PRECAUTIONS FOR PROPER USE

Sensor head



- Never use this product as a sensing device for personnel protection.
- In case of using sensing devices for personnel protection, use products which meet laws and standards, such as OSHA, ANSI or IEC etc., for personnel protection applicable in each region or country.

- Always use the sensor head and the exclusive amplifier together as a set.

Mounting

Ultra-slim type

• With tapped screws

<Side sensing>

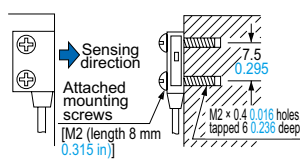

<Front sensing>

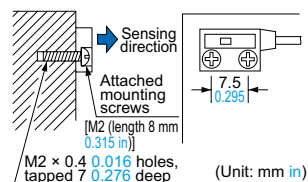

The tightening torque should be 0.14 N·m or less.

• With attached screws and nuts

<Side sensing>

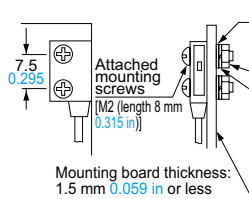

<Front sensing>

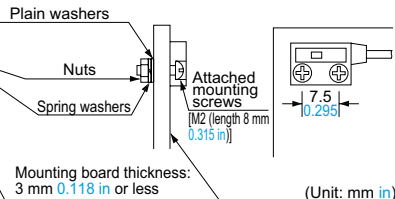

The tightening torque should be 0.14N·m or less.

For ultra-small type, mark sensor & glass substrate detection sensor

- The tightening torque should be 0.29 N·m or less when mounting the sensor head with the screws.

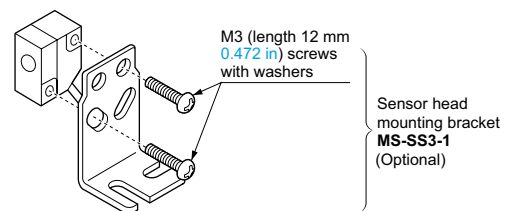

Chemical resistant type

- Use M3 screws to mount the sensor head with the attached sensor head mounting bracket.

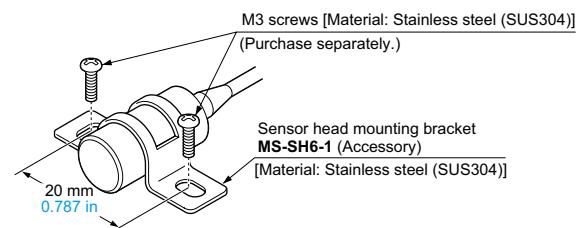

- Use M4 screws to assemble the sensor head with the optional sensor head mounting bracket **MS-SH6-2**, in order to form the convergent sensing mode.

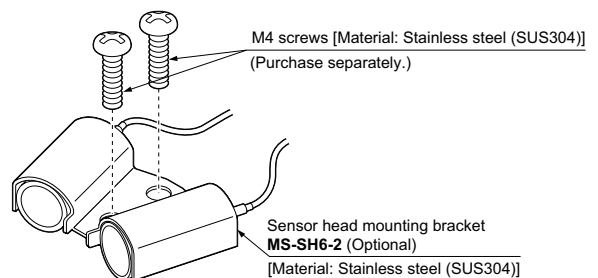

In case of chemical resistant type sensor head

- Do not use where it can be exposed to molten alkali metals (sodium, potassium, lithium, etc.), fluorine gas (F₂), ClF₃, OF₂ (including gaseous state), etc.
- In case of cable extension, the extended portion should be placed in an area where it is not exposed to chemicals.

PRECAUTIONS FOR PROPER USE

Amplifier

Wiring

- The self-diagnosis output does not incorporate a short-circuit protection circuit. Do not connect it directly to a power supply or a capacitive load.

Sensitivity setting

•Normal sensitivity setting

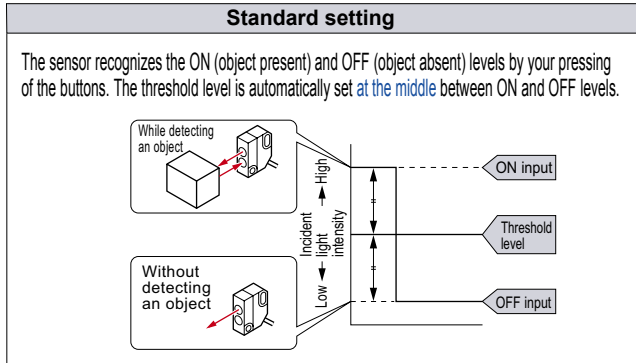

•Maximum sensitivity setting

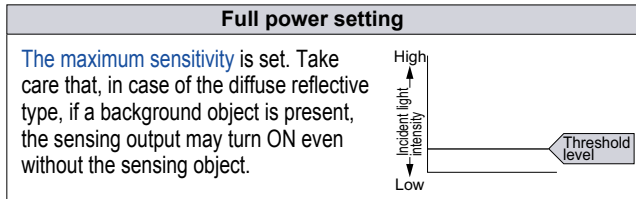

*How to set sensitivity with external inputs

Remote sensitivity setting (SU-77 only)

Instead of pressing buttons, the sensitivity can be set with the remote sensitivity setting inputs. (There is no external sensitivity shift mode.)

Setting procedure

The procedure is the same as for setting with sensitivity buttons, except that instead of pressing the buttons, the remote sensitivity setting input wire is short-circuited to 0 V. The mode selection switch is set to either the "SET" or "RUN" side.

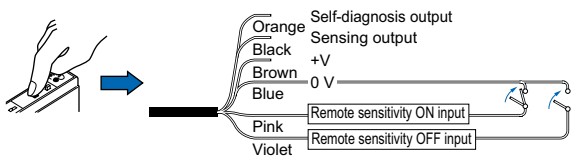

•Time chart

The self-diagnosis output stays ON for 40 ms approx. after ON input or OFF input is recognized by the sensor.

If the difference between the ON and OFF levels (the difference between incident light levels) is so small that stable detection is not possible, it does not turn ON.

Power supply	ON	[High pulse]
Power supply	OFF	[Low pulse]
Remote sensitivity ON input	High	[Pulse with T1, T2]
Remote sensitivity ON input	Low	[Pulse with T1, T2]
Remote sensitivity OFF input	High	[Pulse with T5, T2]
Remote sensitivity OFF input	Low	[Pulse with T5, T2]
Self-diagnosis output (Answer back function)	ON	[Pulse with T3, T4]
Self-diagnosis output (Answer back function)	OFF	[Pulse with T3, T4]
Sensing output		[Sensing possible]

T1 ≥ 1,000 ms, 3,000 ms > T2 ≥ 5 ms, T3 ≈ 310 ms, T4 ≈ 40 ms, T5 ≥ 500 ms

Notes: 1) Signal condition ... Low: 0 to 1 V, High: 4.5 to 30 V, or open Input impedance: 10 kΩ
2) Do not move the object, etc., or change the incident light intensity during T3.

•Sensitivity for detecting minute differences

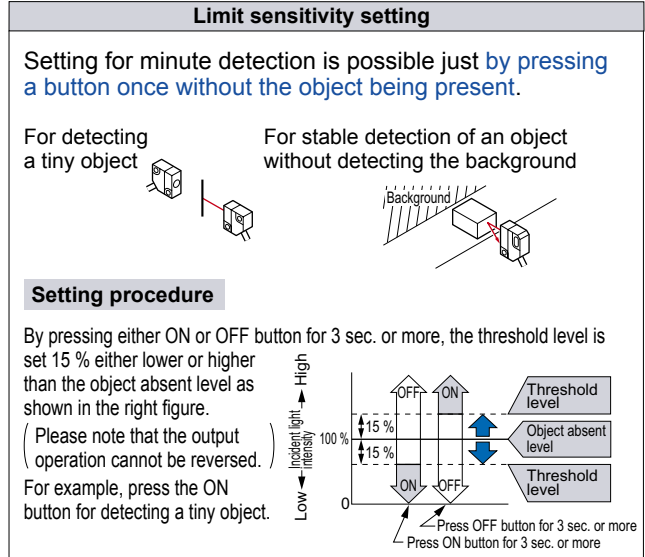

•For applications in which beam intensity fluctuates

Sensitivity shift

If the incident light is stable in either the object present or object absent state, by shifting the threshold level towards this state, stable sensing is possible even if the incident light is unstable in the other state. The setting level is the same as for limit sensitivity setting. However, since the operating level is shifted after the normal sensitivity setting, output operation is selectable.

Setting procedure

Press the sensitivity setting button which was pressed in the stable light received condition. For example, for a diffuse reflective type sensor, in case a background object is present, press the button which was pressed with only the background object being sensed.

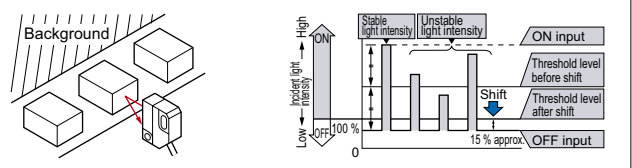

Remote sensitivity selection function (SU-79 only)

- SU-79 can store four channels of sensitivity levels, which can be selected as per your requirement. Designate the channel that is to store the sensitivity by making the remote sensitivity selection inputs 1 and 2 suitably High or Low.

Wiring

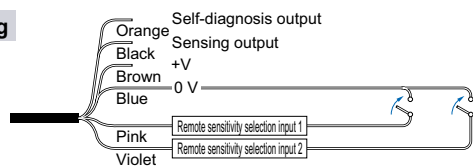

Signal condition

Low: 0 to 1 V
High: 4.5 to 30 V, or open
Input impedance: 10 kΩ

Channel selection

Channel	Input	Remote sensitivity selection input 1	Remote sensitivity selection input 2
1		Low	Low
2		Low	High
3		High	Low
4		High	High

PRECAUTIONS FOR PROPER USE

Amplifier

External synchronization function (SU-75 only)

- The external synchronization function can be used to control the timing of sensing. Edge trigger or gate trigger are available.

	Edge trigger	Gate trigger
Sensing signal	ON OFF	ON OFF
External sync. input	High Low	High Low
Sensing output	ON OFF	ON OFF
External sync. selection switch		

$T \geq 0.6$ ms ($T \geq 0.8$ ms when the interference prevention function is used)
Note: The external synchronization selection switch must be turned fully clockwise or counterclockwise.

Test input (emission halt) function (SU-75 only)

- When the test input (emission halt input) (violet) is short-circuited to 0 V (Low), the beam emission is halted. This function is useful for a start-up test since the sensing output can be made ON/OFF without the sensing object. Short-circuit to 0 V and open the input, repeatedly. If the sensing output follows this operation, the sensor is working well, else not.

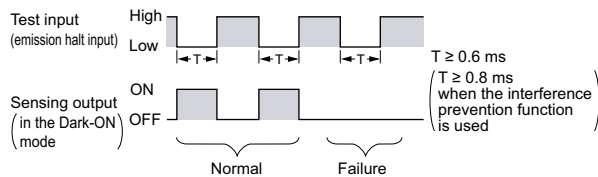

Timer function (Excluding SU-75)

- Every SU-7 series amplifier (excluding SU-75) is incorporated with a variable ON/OFF delay timer for 0 to 5 sec.

ON-delay

As only longer signals are extracted, this function is useful for detecting if a line is clogged, or for sensing only objects taking a long time to travel.

OFF-delay

Since the output signal is extended for a fixed time interval, this function is useful if the output signal is so short that the connected device cannot respond.

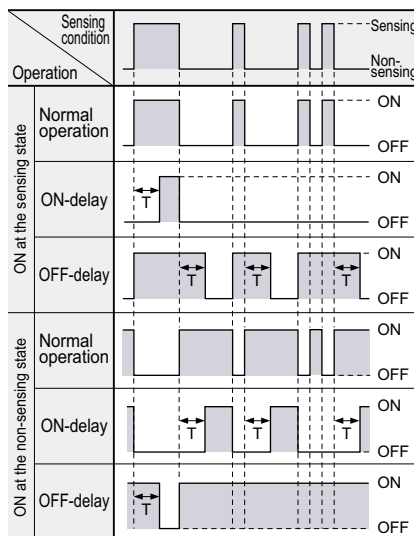

Timer period: $T = 0$ to 5 sec.

• Timer period setting

Adjust the time duration of ON or OFF delay by turning the timer adjuster.

Note: Adjust the timer under "SET" mode. Adjustment is not allowed in "SIF" or "RUN" mode.

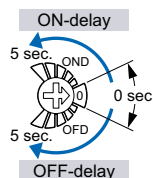

Self-diagnosis function

- The sensor checks the incident light intensity, and if it is reduced due to dirt or dust, or beam misalignment, an output is generated.

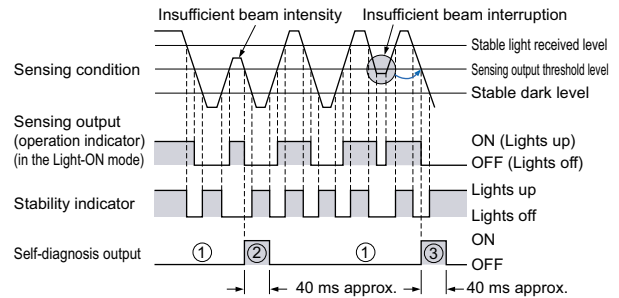

- The self-diagnosis output transistor stays in the "OFF" state during stable sensing.
- When the sensing output changes, if the incident light intensity does not reach the stable light received level or the stable dark level, the self-diagnosis output becomes ON. It is automatically restored after 40 ms approx. Further, the self-diagnosis output changes state when the sensing output changes from Light to Dark state. (It is not affected by the output operation of the sensing) output.
- In case of insufficient beam interruption, there will be a time lag before the self-diagnosis output turns ON.

Use conditions to comply with CE Marking (SH-3□ only)

- Following work must be done in case of using this product as a CE marking (European standard EMC Directive) conforming product.

Place ferrite core at the sensor cable.

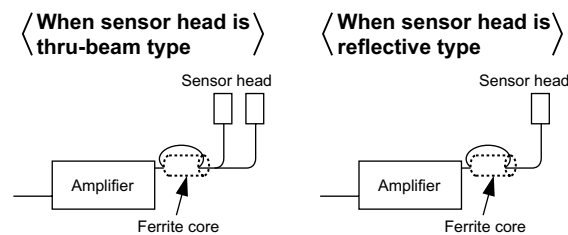

Place a ferrite core near the amplifier.

In that condition, the sensor head cable should be single-winding.

Prepare 1 pc. of the following recommended ferrite core (or an equivalent product.)

<Recommended product>

ESD-SR-110 [NEC TOKIN Corporation]

Others

- Do not use during the initial transient time (0.5 sec.) after the power supply is switched on.

DIMENSIONS (Unit: mm in)

The CAD data can be downloaded from our website.

SH-82R SH-82G SH-84R Sensor head

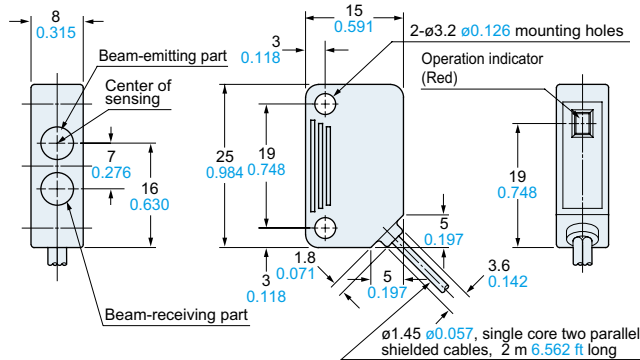

SH-72 Sensor head

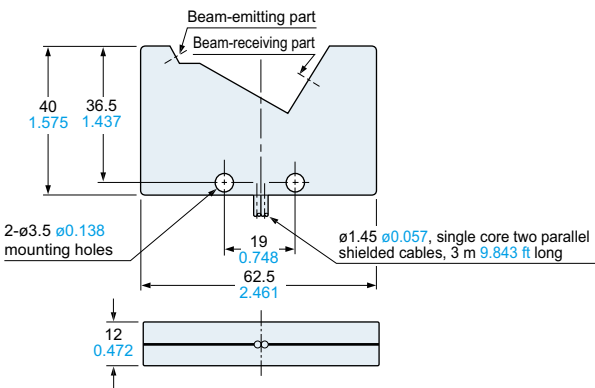

SH-61R Sensor head

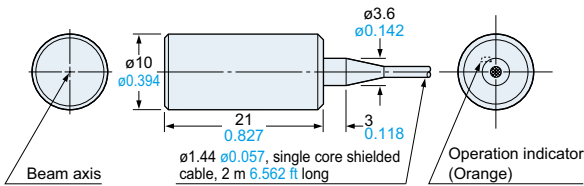

MS-SH6-1 Sensor head mounting bracket (Accessory for SH-61R)

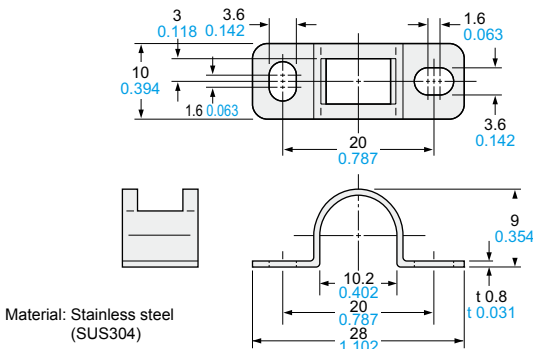

SU-CT1 Stripper (Accessory for amplifier)

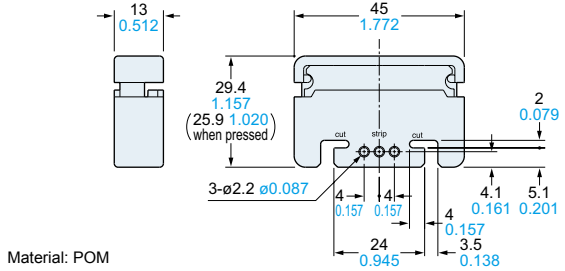

MS-DS-1 Sensor head mounting bracket (Optional)

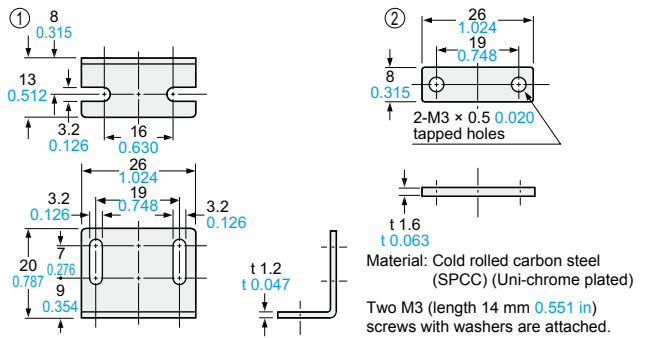

MS-SS3-1 Sensor head mounting bracket (Optional)

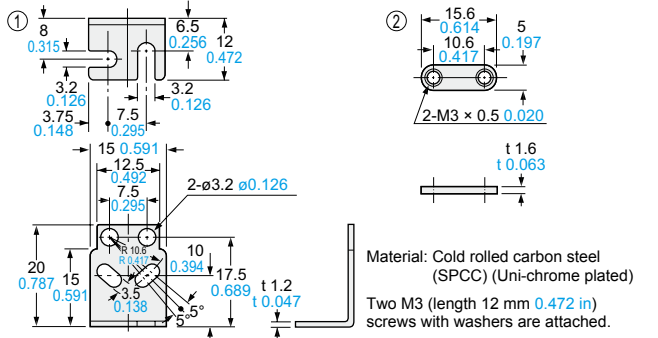

MS-SH6-2 Sensor head mounting bracket (Optional)

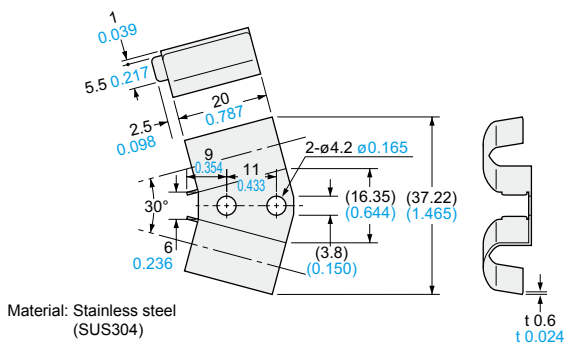

Disclaimer

The applications described in the catalog are all intended for examples only. The purchase of our products described in the catalog shall not be regarded as granting of a license to use our products in the described applications. We do NOT warrant that we have obtained some intellectual properties, such as patent rights, with respect to such applications, or that the described applications may not infringe any intellectual property rights, such as patent rights, of a third party.

Panasonic
INDUSTRY

Panasonic Industry Co., Ltd.

Industrial Device Business Division

7-1-1, Morofuku, Daito-shi, Osaka 574-0044, Japan

industrial.panasonic.com/ac/e/