

Products Catalog

**Conductive Polymer Aluminum
Electrolytic Capacitors
SP-Cap**

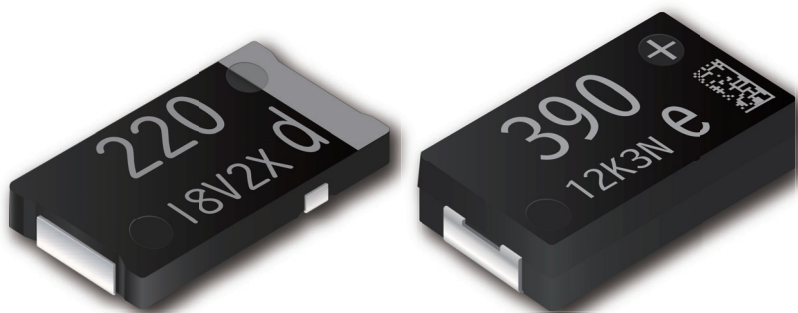

**IN Your
Future**



Conductive Polymer Aluminum Electrolytic Capacitors INDEX

	Item	Page
	<u>Safety and Legal Matters to Be Observed / Matters to Be Observed When Using This Product</u>	1
Selection guide	<u>Line-up</u>	5
	<u>Series flow chart</u>	6
	<u>Voltage-Capacitance table</u>	7
	<u>Explanation of part numbers</u>	9
	<u>Mounting specifications</u>	10
	<u>Packing specifications</u>	11
Series	<u>JX</u> : Endurance 125 °C 3000 h	12
	<u>KX</u> : Endurance 125 °C 5500 h	14
	<u>TX</u> : Endurance 135 °C 5500 h	16
	<u>JZ</u> : Large cap., Endurance 125 °C 3000 h	18
	<u>KZ</u> : Large cap., Endurance 125 °C 5500 h	20
	<u>TZ</u> : Large cap., Endurance 135 °C 5500 h	22
	<u>CS,CT,CX</u> : High voltage, Low profile	24
	<u>SX</u> : Large capacitance, Low ESR	27
	<u>GX/GX-L</u> : Large capacitance, Super low ESR	29
	<u>LX</u> : Large capacitance, Low ESR	31
	<u>SR,LR,SS,LS,ST,LT</u> : Low profile, Low ESR	33
	<u>GY</u> : Super low ESR, Large capacitance	35
	<u>CY,SY</u> : Endurance 85 °C 2000 h	37
<u>HX</u> : Endurance 125 °C 1000 h	39	
	<u>Replacement list for “Not recommended for new design”</u>	41

Safety and Legal Matters to Be Observed

Product specifications and applications

- Please be advised that this product and product specifications are subject to change without notice for improvement purposes. Therefore, please request and confirm the latest delivery specifications that explain the specifications in detail before the final design, or purchase or use of the product, regardless of the application. In addition, do not use this product in any way that deviates from the contents of the company's delivery specifications.
- Unless otherwise specified in this catalog or the product specifications, this product is intended for use in general electronic equipment (AV products, home appliances, commercial equipment, office equipment, information and communication equipment, etc.).
When this product is used for the following special cases, the specification document suited to each application shall be signed/sealed (with Panasonic Industry and the user) in advance..These include applications requiring special quality and reliability, wherein their failures or malfunctions may directly threaten human life or cause harm to the human body (e.g.: space/aircraft equipment, transportation/traffic equipment, combustion equipment, medical equipment, disaster prevention/crime prevention equipment, safety equipment, etc.).

Safety design and product evaluation

- Please ensure safety through protection circuits, redundant circuits, etc., in the customer's system design so that a defect in our company's product will not endanger human life or cause other serious damage.
- This catalog shows the quality and performance of individual parts. The durability of parts varies depending on the usage environment and conditions. Therefore, please ensure to evaluate and confirm the state of each part after it has been mounted in your product in the actual operating environment before use.
If you have any doubts about the safety of this product, then please notify us immediately, and be sure to conduct a technical review including the above protection circuits and redundant circuits at your company.

Laws / Regulations / Intellectual property

- The transportation of dangerous goods as designated by UN numbers, UN classifications, etc., does not apply to this product. In addition, when exporting products, product specifications, and technical information described in this catalog, please comply with the laws and regulations of the countries to which the products are exported, especially those concerning security export control.
- Each model of this product complies with the RoHS Directive (Restriction of the use of hazardous substances in electrical and electronic equipment) (2011/65/EU and (EU) 2015/863). The date of compliance with the RoHS Directive and REACH Regulation varies depending on the product model.
Further, if you are using product models in stock and are not sure whether or not they comply with the RoHS Directive or REACH Regulation, please contact us by selecting "Sales Inquiry" from the inquiry form.
- During the manufacturing process of this product and any of its components and materials to be used, Panasonic Industry does not intentionally use ozone-depleting substances stipulated in the Montreal Protocol and specific bromine-based flame retardants such as PBBs (Poly-Brominated Biphenyls) / PBDEs (Poly-Brominated Diphenyl Ethers). In addition, the materials used in this product are all listed as existing chemical substances based on the Act on the Regulation of Manufacture and Evaluation of Chemical Substances.
- With regard to the disposal of this product, please confirm the disposal method in each country and region where it is incorporated into your company's product and used.
- The technical information contained in this catalog is intended to show only typical operation and application circuit examples of this product. This catalog does not guarantee that such information does not infringe upon the intellectual property rights of Panasonic Industry or any third party, nor imply that the license of such rights has been granted.
- Design, materials, or process related to technical owned by Panasonic Industry are subject to change without notice.

Panasonic Industry will assume no liability whatsoever if the use of our company's products deviates from the contents of this catalog or does not comply with the precautions. Please be advised of these restrictions.

Matters to Be Observed When Using This Product

(Conductive Polymer Aluminum Electrolytic Capacitors / SP-Cap)

Use environments and cleaning conditions

- This product (capacitor) is intended for standard general-purpose use in electronic equipment, and is not designed for use in the specific environments described below. Using the product in such specific environments or service conditions, therefore, may affect the performance of the product.
Please check with us about the performance and reliability of the product first before using the product.

- (1) Used in liquid, such as water, oil, chemicals, and organic solvents.
- (2) Used in a place exposed to direct sunlight, an outdoor place with no shielding, or a dusty place.
- (3) Used in a wet place (dew concentration on a resistor, water leakage, etc.), a place exposed to sea breeze, or a place filled with a corrosive gas, such as Cl_2 , H_2S , NH_3 , SO_2 , or NO_x .
- (4) Used in an environment where static electricity and electromagnetic waves are strong.
- (5) The product is located close to a heating component or a flammable material, such as a vinyl cable, is placed near the product.
- (6) The product is used sealed with a resin, etc.
- (7) Solder flux of the soldered product is cleansed with a solvent, water, and a water-soluble cleaner.
(Be careful with water soluble solder flux.)
- (8) Used in an environment where an acidic or alkali atmosphere is present.
- (9) Used in an environment where excessive vibration or impact is applied to the product.
- (10) Used under a low atmospheric pressure condition or depressurized condition.

- After soldering, clean the circuit board at a temperature of 60°C or lower for 5 minutes or less. However, ensure to thoroughly rinse and dry it (at 100°C for 20 minutes or less). The applicable solvents are as follows.

Pine Alpha ST-100S, Clean-thru 750H/750L/710M, Aqua Cleaner 210SEP, Sunelec B-12, DK be-clear CW-5790, Techno Cleaner 219, Cold Cleaner P3-375, Terpene Cleaner EC-7R, Techno Care FRW-17/FRW-1/FRV-1, AXREL 32, IPA (isopropyl alcohol)

- (1) Please contact us in advance for the use of cleaning agents other than those listed above and water except pure water.
- (2) Avoid using ozone-depleting substances as cleaning agents to protect the global environment.
- (3) Performing ultrasonic cleaning may cause terminal disconnection, which requires prior evaluation.

- Do not apply strong force to this product. Doing so may adversely affect mounting by causing the deformation of electrode terminals or other defects.

In addition, the application of strong force may also lead to short circuits, disconnection, increased leakage currents, and damage to the outer packaging of the product. Do not hold the body of the product or apply force even after it is attached to the circuit board.

- When the capacitor is used in a circuit where an impact voltage is applied or a high voltage is applied in a short period (transient phenomenon) or a high pulse voltage is applied, make sure to use the capacitor at a voltage equal to or lower than its rated voltage.

Response to anomalies and handling conditions

If this product heats up abnormally, then smoke may be generated from the exterior resin. In this case, immediately turn off the main power of the equipment and stop using it. Also, keep your face and hands away from the product as it may become hot and cause burns.

Reliability and product life

- Most of the failure modes are "short circuits" or "increased leakage currents." The main causes of failures are thermal stress, electrical stress, and mechanical stress due to reflow and operating temperature environments.
Even within the range of the specified use conditions, it is possible to reduce the failure rate by mitigating the operating conditions such as the temperature and voltage. Therefore, please design equipment with a sufficient margin.
- The estimated failure rate is 8.2 Fit or less (estimated at 105°C when the rated voltage is applied) based on data obtained from the company's reliability test, while the estimated market failure rate is 0.13 Fit or less (estimated at $c = 0$ and a confidence level of 60%).

Circuit design and circuit board design

- Do not use this product in high-impedance voltage holding circuits, coupling circuits, time constant circuits, and those that are significantly affected by leakage currents. Also, do not connect two or more units of this product in series.
- Applying overvoltage that exceeds the rated voltage specified in the specifications or reverse voltage to this product may cause an increase in leakage currents or short circuits.
Applied voltage refers to the voltage value applied to a circuit, including the effects of the peak values of ripple voltage and transient instantaneous voltage, and does not only indicate the steady line voltage value. Design circuits so that the peak voltage does not exceed the specified voltage.
Use this product by regulating the operating voltage to keep it lower than or equal to the rated voltage even for impulse voltage circuits, applications involving transient phenomena where a considerably high voltage is applied in a short time, and cases where high pulse voltages are applied.
- Keep the operating temperature within the range stipulated in the specifications. Design your equipment in consideration of not only the ambient temperature where the equipment is placed and its internal temperature, but also the radiant heat from heating elements (power transistors, resistors, etc.) inside the equipment, and the temperature of this product, including self-heating due to ripple current.
- Regulate the ripple current within the rated range specified in the specifications when using the product.
Excessive ripple current causes increased leakage currents and short circuit failures due to self-heating.
Even if the ripple current is within the rated range, prevent the ripple voltage from applying overvoltage or reverse voltage to the product.
- The ESR rating is the value at the time of shipment from the factory. The ESR value may vary depending on the customer's usage conditions.
- Leakage currents may increase after reflow soldering, and also under no-load conditions at high temperatures, in high temperature and high humidity environments, or with sudden temperature changes, even if the operating environment is within the specified range. However, in most cases, SP-Cap reduces leakage currents due to its self-recovery action when voltage is applied.
- Insulate the circuit board surface directly under the mounting area of this product. Lay out your circuit board by defining the dimensions of lands with reference to the mounting specifications stipulated in the requirements.
The dimensions of the actual design circuit should enable the optimum mounting depending on conditions such as the circuit board, parts, and reflow.

Mounting and storage conditions

- Check the rating (capacitance, rated voltage), polarity, and land dimensions of this product before mounting it on the circuit board. When using mounting equipment, large pressure applied during mounting may lead to an increase in leakage currents, short circuits, disconnection, or falling off from the circuit board.
- Do not use flow and dip soldering. Reflow soldering can be used with the following methods. Please refer to the mounting specifications for the recommended conditions for using the atmospheric heat conduction method. Please contact us for the recommended conditions for using the VPS method.
 - (1) Atmospheric heat conduction method (infrared ray/hot-air system)
 - (2) VPS method (target series: CX, CT, SX, ST, GX, LX, LT, and HX)
- Soldering must be performed at a temperature of 350°C or lower at the tip of the soldering iron and within an operation time of 10 seconds, without applying excessive force to the product.
In addition, do not remove this product for reuse once it is mounted. Soldering outside the specified conditions can cause short circuit failures, an increase in ESR, and other defects.
- Store this product in an environment with a temperature ranging from 5°C to 30°C and a humidity of 70% or lower by using a moisture-proof bag. The storage period before opening the moisture-proof bag is two years after manufacture, and after opening the bag is seven days. If these conditions are exceeded, then the outer package may be damaged due to thermal stress during mounting caused by moisture absorption by the package.
After opening the bag, use up all pieces of this product within the specified storage period.
- This product is composed of various metals and resins, requiring disposal as industrial waste.

Reference information

Guidelines

The matters to be observed when using this product cite the technical report issued by the Japan Electronics and Information Technology Industries Association, and EIAJ RCR-2367D issued in October 2017, "Safety application guide for fixed aluminum electrolytic capacitors for use in electronic equipment." Please refer to the above technical report for details.

Intellectual property

Panasonic Group provides customers with safe products and services. We are also making great efforts to protect our intellectual property rights for Panasonic Group products. Typical patents related to this product are as follows.

[U.S. patent]

USP Nos. 7136276, 7787234

Line up

■ Long life products

Series	Part No.	Feature	Low profile	Low ESR	Low ESL	Large cap.	High temp.	Long life	High voltage	Category temperature (°C)	Rated voltage (V)	ESR (mΩ)	Capacitance (μF)	Size (mm)
														L x W
														7.3x4.3
														H
JX	EEFJX---	Guaranteed at 125 °C 3000 h		●			●	●		-55 to 125	2 to 6.3	3 to 15	120 to 470	1.9
KX	EEFKX---	Guaranteed at 125 °C 5500 h		●			●	●		-55 to 125	2 to 6.3	3 to 15	120 to 470	1.9
TX	EEFTX---	Guaranteed at 135 °C 5500 h		●			●	●		-55 to 135	2 to 6.3	3 to 15	120 to 470	1.9
JZ	EEFJZ---	Guaranteed at 125 °C 3000 h Large capacitance		●		●	●	●		-55 to 125	2	3 to 9	560	2.2
KZ	EEFKZ---	Guaranteed at 125 °C 5500 h Large capacitance		●		●	●	●		-55 to 125	2	3 to 9	560	2.2
TZ	EEFTZ---	Guaranteed at 135 °C 5500 h Large capacitance		●		●	●	●		-55 to 135	2	3 to 9	560	2.2

■ Standard products

Series	Part No.	Feature	Low profile	Low ESR	Low ESL	Large cap.	High temp.	Long life	High voltage	Category temperature (°C)	Rated voltage (V)	ESR (mΩ)	Capacitance (μF)	Size (mm)
														L x W
														7.3x4.3
														H
CX	EEFCX---	Standard							●	-55 to 105	2 to 35	12 to 40	15 to 560	1.9
CT	EEFCT---	Low profile	●						●	-55 to 105	4 to 35	15 to 40	15 to 180	1.4
CS	EEFCS---	Low profile	●						●	-55 to 105	4 to 35	15 to 40	10 to 120	1.1
SX	EEFSX---	Low ESR		●						-55 to 105	2 to 6.3	4.5 to 9	82 to 560	1.9
GX	EEFGX---	Super low ESR High ripple current		●						-55 to 105	2, 2.5	3	330 to 560	1.9
LX	EEFLX---	Low ESR · Low ESL		●	●					-55 to 105	2, 2.5	4.5 to 6	330 to 560	1.9
ST	EEFST---	Low profile · Low ESR	●	●						-55 to 105	2, 2.5	6	270 to 330	1.4
LT	EEFLT---	Low profile Low ESR · Low ESL	●	●	●					-55 to 105	2, 2.5	6	270 to 330	1.4
SS	EEFSS---	Low profile · Low ESR	●	●						-55 to 105	2, 2.5	6	180 to 220	1.1
LS	EEFLS---	Low profile Low ESR · Low ESL	●	●	●					-55 to 105	2, 2.5	6	180 to 220	1.1
SR	EEFSR---	Low profile (1.0 mm max.) Low ESR	●	●						-55 to 105	2 to 6.3	4.5 to 9	68 to 220	1.0max.
LR	EEFLR---	Low profile (1.0 mm max.) Low ESR · Low ESL	●	●	●					-55 to 105	2 to 6.3	4.5 to 9	68 to 220	1.0max.
GY	EEFGY---	Super low ESR / High ripple current / Height 3.0 mm max.		●		●				-55 to 105	2, 2.5	3	680 to 820	2.8
CY	ECGCY---	Guaranteed at 85 °C Height 3.0 mm max.				●				-55 to 85	4, 6.3	15	330 to 470	2.8
SY	ECGSY---	Low ESR / Guaranteed at 85 °C / Height 3.0 mm max.		●		●				-55 to 85	4, 6.3	9	330 to 470	2.8
HX	EEFHX---	Guaranteed at 125 °C					●	●		-55 to 125	2 to 25	4.5 to 40	15 to 470	1.9

• 2 to 6.3 V : On sale
 • 10 to 35 V : Not recommended for new design
 ※ Click [here](#) for Replacement (10 to 35 V)

Series flow chart

■ Long life products

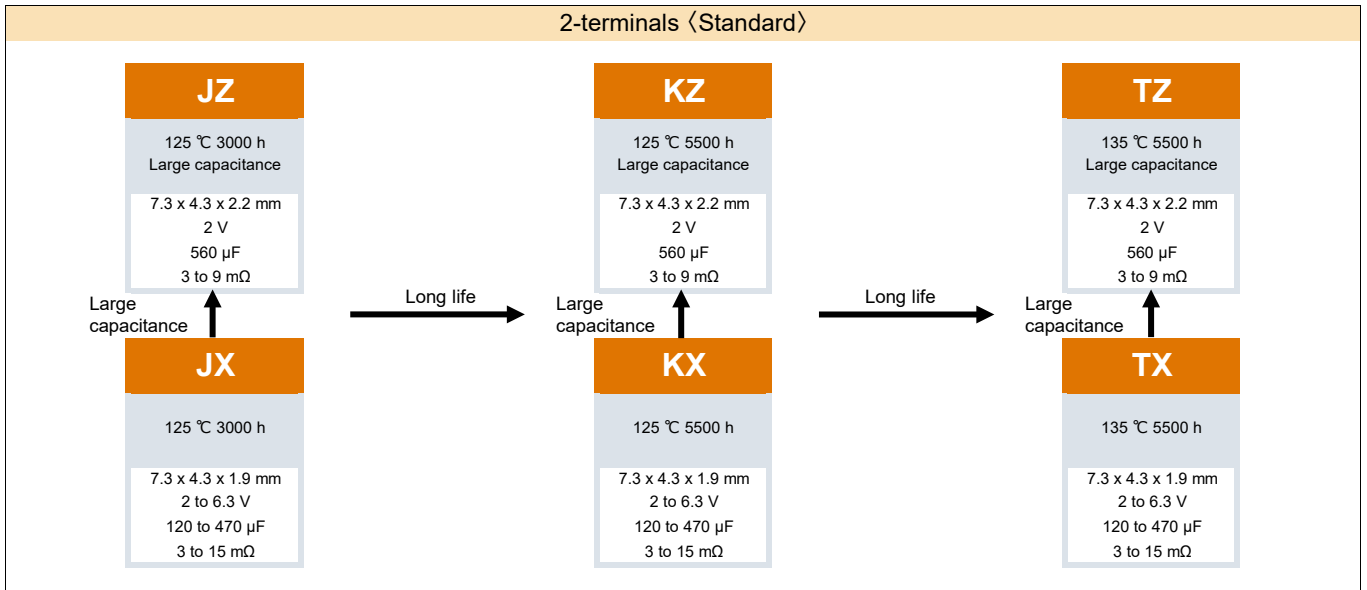

■ Standard products

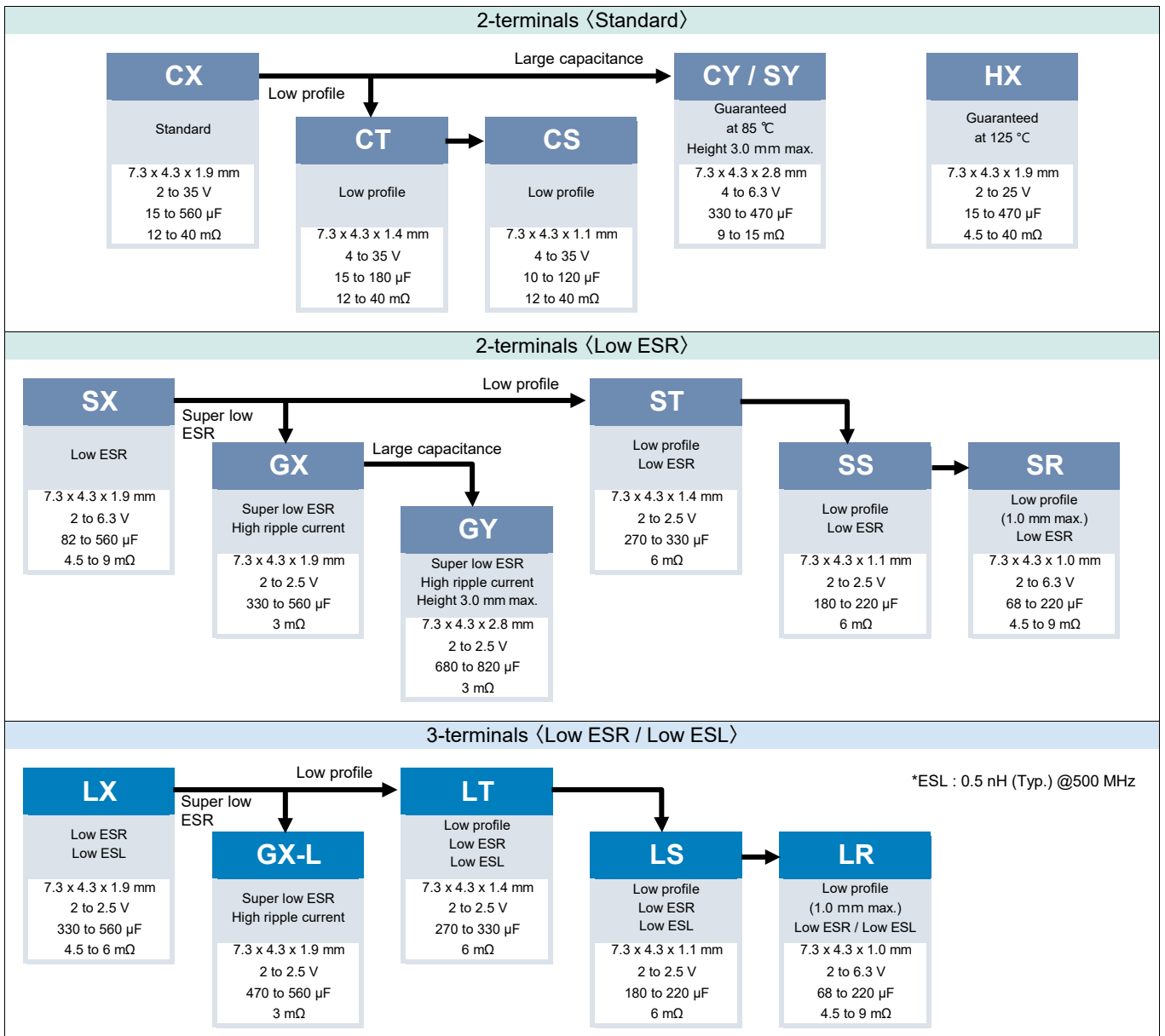

Voltage - Capacitance table (Vol. : 2.0 to 6.3 V / Cap. : 10 to 120 μ F)

Series
(ESR m Ω)

V	μ F	10	15	22	33	47	56	68	82	100	120
2.0											
2.5											
4.0									SX (9)	SX (9)	CS (15)
											SR (9)
											LR (9)
6.3								CS (15)		CT (15)	CX (15)
								SR (9)		CX (15)	SX (7)
								LR (9)			JX (15)
											KX (15)
											TX (15)

Size list LxWxH (mm)

SR, LR	7.3 x 4.3 x 1.0 max.	CX, GX, LX, LX, JX, KX, TX, HX	7.3 x 4.3 x 1.9
SS, LS, CS	7.3 x 4.3 x 1.1	JZ, KZ, TZ	7.3 x 4.3 x 2.2
CT, ST, LT	7.3 x 4.3 x 1.4	CY, SY	7.3 x 4.3 x 2.8

Voltage - Capacitance table (Vol. : 2.0 to 6.3 V / Cap. : 150 to 820 μ F)

Series
(ESR m Ω)

V	μ F	150	180	220	270	330	390	470	560	680	820
2.0			SX (9)	CX (15)	CX (12)	CX (15,12)	CX (15)	CX (15)	CX (15)		GY (3)
				SX (9)	SX (9,6,4.5)	SX (9,6,4.5)	SX (9,6,4.5)	SX (9,6,4.5)	SX (4.5)		
				SR (6,4.5)		GX (3)		GX (3)	GX (3)		
				LR (6,4.5)		LX (6,4.5)		GX-L (3)	GX-L (3)		
				SS (6)		ST (6)		LX (6,4.5)	LX (6,4.5)		
				LS (6)		LT (6)		JX (9,4.5,3)	JZ (9,4.5,3)		
						JX (9)		KX (9,4.5,3)	KZ (9,4.5,3)		
						KX (9)		HX (15,9,6,4.5)	TZ (9,4.5,3)		
						TX (9)		TX (9,4.5,3)			
2.5		SX (9)	SX (9)	CX (15)	SX (7)	CX (15)	CX (15)	CX (15)		GY (3)	
			SR (6,4.5)	SX (9,7)	ST (6)	SX (9,6)	SX (9,6,4.5)	SX (9,6,4.5)			
			LR (6,4.5)	JX (9)	LT (6)	GX (3)	JX (9,4.5,3)	GX (3)			
			SS (6)	KX (9)		LX (6,4.5)	KX (9,4.5,3)	GX-L (3)			
			LS (6)	TX (9)		JX (9)	TX (9,4.5,3)	LX (6,4.5)			
						KX (9)		JX (9,4.5,3)			
						HX (15,9,6,4.5)		KX (9,4.5,3)			
						TX (9)					
4.0		CX (15)	CT (15)	CX (15, 12)	CX (15)	CX (15)		CY (15)			
		SX (9,7)	CX (15,12)	SX (9)	SX (9)	SX (9,6)		SY (15)			
		JX (15)	SX (9)	JX (15)							
		KX (15)	JX (15)	KX (15)							
		TX (15)	KX (15)	TX (15)							
			TX (15)								
6.3		CX (15,12)	CX (15)	CX (15)		CY (15)					
		SX (9)	SX (9)	SX (9)		SY (9)					
		JX (15)									
		KX (15)									
		TX (15)									

Size list LxWxH (mm)

SR, LR	7.3 x 4.3 x 1.0 max.	CX, GX, LX, LX, JX, KX, TX, HX	7.3 x 4.3 x 1.9
SS, LS, CS	7.3 x 4.3 x 1.1	JZ, KZ, TZ	7.3 x 4.3 x 2.2
CT, ST, LT	7.3 x 4.3 x 1.4	CY, SY	7.3 x 4.3 x 2.8

Explanation of part numbers

◇ Part number system

EEF		CX		0E		471		R	
Product classification 3 figures		Series 2 figures		Voltage code 2 figures		Capacitance code 3 figures		Special code 1 to 2 figures	
Series	Product classification	Series	Code	Voltage (V)	Code	Cap. (μF)	Code		
JX	EEF	JX	JX	2	0D	10	100		
KX		KX	KX	2.5	0E	15	150		
TX		TX	TX	4	0G	22	220		
JZ		JZ	JZ	6.3	0J	33	330		
KZ		KZ	KZ	10	1A	47	470		
TZ		TZ	TZ	16	1C	56	560		
CX		CX	CX	20	1D	68	680		
CT		CT	CT	25	1E	100	101		
CS		CS	CS	35	1V	120	121		
SX		SX	SX			150	151		
LX		LX	LX			180	181		
GX		GX	GX			220	221		
ST		ST	ST			270	271		
LT		LT	LT			330	331		
SS		SS	SS			390	391		
LS		LS	LS			470	471		
SR		SR	SR			560	561		
LR		LR	LR			680	681		
GY	GY	GY			820	821			
CY	ECG	CY	CY						
SY		SY	SY						
HX	EEF	HX	HX						

Height (mm)	Series	Special code	ESR (mΩ max.)	Terminals	
				2	3
1.9 ± 0.1	JX KX TX	RF	15	○	
		RE	9	○	
		RC	4.5	○	
		RB	3	○	
2.2 ± 0.1	JZ KZ TZ	RE	9	○	
		RC	4.5	○	
		RB	3	○	
1.9 ± 0.1	CX	R	15 (to 6.3 V), 40 (10 V to 35 V)	○	
		XR	12	○	
	SX	ER	9	○	
		E7	7	○	
		XE	6	○	
	GX	R	3	○	
		L	3		○
	LX	R	6		○
		R4	4.5		○
		R	15 (to 2.5 V), 40 (10 V to 25 V)	○	
	HX	R9	9	○	
		R6	6	○	
R4		4.5	○		
R		15 (to 6.3 V), 40 (10 V to 35 V)	○		
1.4 ± 0.1	CT ST LT	R	6	○	
		R	6		○
		R	6		○
1.1 ± 0.1	CS SS LS	R	15 (to 6.3 V), 40 (10 V to 35 V)	○	
		R	6	○	
		R	6		○
1.0 (max.)	SR	R	6 (to 2.5 V), 9 (4 V to 6.3 V)	○	
		R4	4.5	○	
	LR	R	6 (to 2.5 V), 9 (4 V to 6.3 V)		○
		R4	4.5		○
2.8 ± 0.2	GY CY SY	R	3	○	
		R	15	○	
		R	9	○	

Mounting specification

● Recommendable reflow soldering

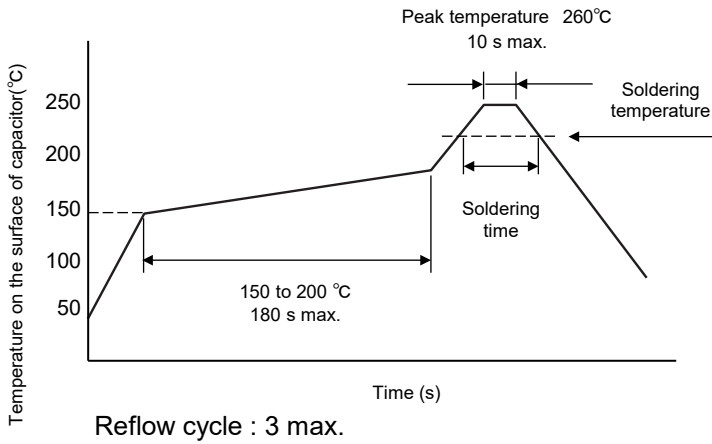

Soldering temperature and soldering time

Temperature	Time
≥ 255°C	30 s max.
≥ 230°C	130 s max.
≥ 217°C	150 s max.

SP-Cap recommended profile condition of the IPC/J-STD-020D standard

● Typical land pattern

□ 2-terminals

For standard terminal (C*, S*, G*, J*, K*, T*, HX series)

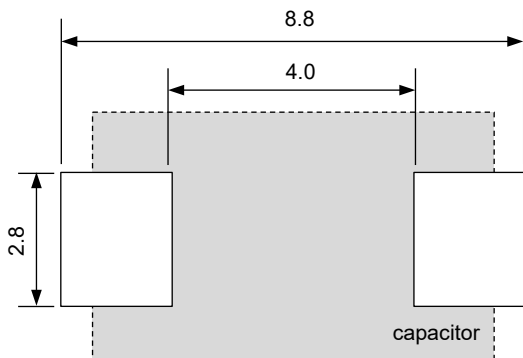

Unit:mm

□ 3-terminals

For low ESL terminal (L*, GX-L series)

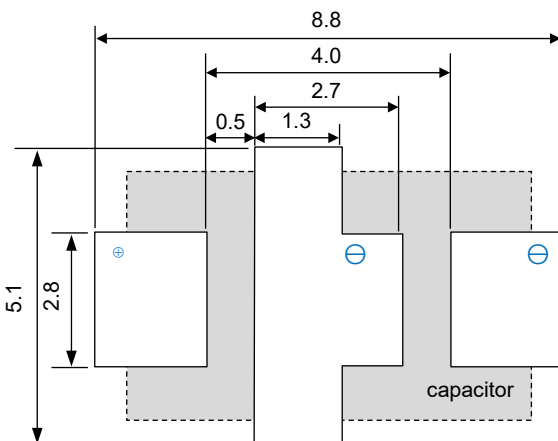

〈VIA〉

For low ESL terminal (L*, GX-L series)

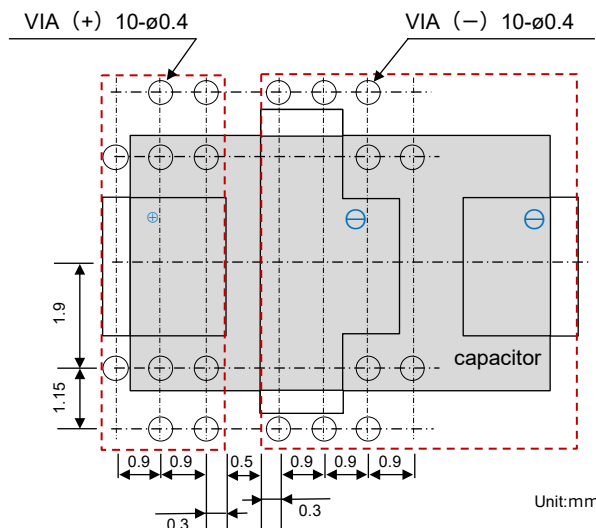

**Conductive Polymer Aluminum
Electrolytic Capacitors**
Surface Mount Type



JX series [High temperature long life product]

Features

- Endurance 125 °C 3000 h
- Damp heat 85°C 85% 1000 h
- Low ESR (3 to 15 mΩ)
- RoHS compliance, Halogen free

Specifications

Series	JX			
Category temp. range	-55 °C to +125 °C			
Rated voltage range	2.0 V to 6.3 V			
Category voltage range	1.6 V, 2.0 V, 3.2 V, 5.0 V			
Rated cap. range	120 μF to 470 μF			
Capacitance tolerance	±20 % (120 Hz / +20 °C)			
DC leakage current	I ≤ 0.1 CV (μA) 2 minutes			
Dissipation factor (tan δ)	≤ 0.1 (120 Hz / +20 °C)			
Surge voltage (V)	Rated voltage × 1.25 (15 °C to 35 °C)			
Endurance	+125 °C 3000 h, category voltage applied			
	Capacitance change	Within ±20 % of the initial value		
	Dissipation factor (tan δ)	≤ 2 times of the initial limit		
	DC leakage current	≤ 3 times of the initial limit		
Damp heat (Steady state)	+85 °C, 85 % RH, 1000 h, No-applied voltage			
	Capacitance change of initial measured value	2.0 V, 2.5 V	4.0 V	6.3 V
		+70 %, -20 %	+60 %, -20 %	+50 %, -20 %
	Dissipation factor (tan δ)	≤ 2 times of the initial limit		
DC leakage current	≤ 5 times of the initial limit			

Marking

Capacitance (μF) Polarity (Positive)

Lot No. R. voltage code 2D code *1

Rated voltage code		Unit : V	
d	2.0	g	4.0
e	2.5	j	6.3

*1: Internal management information

Dimensions (not to scale)

Unit : mm					
Series	L±0.2	W1±0.2	W2±0.1	H±0.1	P±0.3
JX	7.3	4.3	2.4	1.9	1.3

* Externals of figure are the reference.

Explanation of part numbers

◇ Part number system e.g.: EEFJX0D331RE

EEF		JX		0D		331				RE	
Series	Product classification	Series	Code	Rated Voltage (V)	Code	Capacitance (μF)	Code	Capacitance (μF)	Code	ESR (mΩ)	Special code
JX	EEF	JX	JX	2.0	0D	120	121	330	331	3	RB
				2.5	0E	150	151	390	391	4.5	RC
				4.0	0G	180	181	470	471	9	RE
				6.3	0J	220	221			15	RF

Characteristics list

Series	Rated voltage [105 °C] (V)	Category voltage [125 °C] (V)	Capacitance (μF)	Case size (mm)			Specification		Part number	Min. Packaging Qty (pcs)
				L	W	H	Ripple current* ¹ (mA rms)	ESR* ² (mΩ max.)		
JX	2.0	1.6	330	7.3	4.3	1.9	6300	9	EEFJX0D331RE	3500
				7.3	4.3	1.9	6300	9	EEFJX0D471RE	3500
			470	7.3	4.3	1.9	8500	4.5	EEFJX0D471RC	3500
				7.3	4.3	1.9	10200	3	EEFJX0D471RB	3500
	2.5	2.0	220	7.3	4.3	1.9	6300	9	EEFJX0E221RE	3500
				7.3	4.3	1.9	6300	9	EEFJX0E331RE	3500
			390	7.3	4.3	1.9	6300	9	EEFJX0E391RE	3500
				7.3	4.3	1.9	8500	4.5	EEFJX0E391RC	3500
			470	7.3	4.3	1.9	10200	3	EEFJX0E391RB	3500
				7.3	4.3	1.9	6300	9	EEFJX0E471RE	3500
			7.3	7.3	4.3	1.9	8500	4.5	EEFJX0E471RC	3500
				7.3	4.3	1.9	10200	3	EEFJX0E471RB	3500
	4.0	3.2	150	7.3	4.3	1.9	5100	15	EEFJX0G151RF	3500
			180	7.3	4.3	1.9	5100	15	EEFJX0G181RF	3500
			220	7.3	4.3	1.9	5100	15	EEFJX0G221RF	3500
	6.3	5.0	120	7.3	4.3	1.9	5100	15	EEFJX0J121RF	3500
			150	7.3	4.3	1.9	5100	15	EEFJX0J151RF	3500

*1: Ripple current (100 kHz / +45 °C)

*2: ESR (100 kHz / +20 °C)

◆ Please refer to each page in this catalog for "Reflow conditions" and "Taping specifications".

Temperature coefficient of ripple current

Temperature		T ≤ 45 °C	45 °C < T ≤ 85 °C	85 °C < T ≤ 125 °C
2.0 V to 6.3 V	Coefficient	1.0	0.7	0.25

◆ Ripple current should be controlled so that surface temperature of capacitor does not exceed the category temperature.

**Conductive Polymer Aluminum
Electrolytic Capacitors**
Surface Mount Type

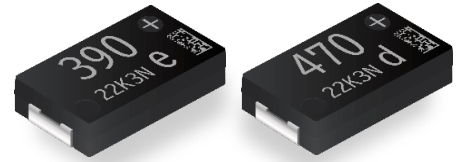

KX series [High temperature long life product]

Features

- Endurance 125 °C 5500 h
- Damp heat 85°C 85% 1000 h
- Low ESR (3 ~ 15 mΩ max.)
- RoHS compliance, Halogen free

Specifications

Series	KX			
Category temp. range	-55 °C to +125 °C			
Rated voltage range	2.0 V to 6.3 V			
Category voltage range	1.6 V, 2.0 V, 3.2 V, 5.0 V			
Rated cap. range	120 μF to 470 μF			
Capacitance tolerance	±20 % (120 Hz / +20 °C)			
DC leakage current	I ≤ 0.1 CV (μA) 2 minutes			
Dissipation factor (tan δ)	≤ 0.1 (120 Hz / +20 °C)			
Surge voltage (V)	Rated voltage × 1.25 (15 °C to 35 °C)			
Endurance	+125 °C 5500 h, category voltage applied			
	Capacitance change	Within ±20 % of the initial value		
	Dissipation factor (tan δ)	≤ 2 times of the initial limit		
	DC leakage current	≤ 3 times of the initial limit		
Damp heat (Steady state)	+85 °C, 85 % RH, 1000 h, No-applied voltage			
	Capacitance change of initial measured value	2.0 V, 2.5 V	4.0 V	6.3 V
		+70 %, -20 %	+60 %, -20 %	+50 %, -20 %
	Dissipation factor (tan δ)	≤ 2 times of the initial limit		
DC leakage current	≤ 5 times of the initial limit			

Marking

R. voltage code		Unit : V	
d	2.0	g	4.0
e	2.5	j	6.3

*1: Internal management information

Dimensions (not to scale)

Series	L±0.2	W1±0.2	W2±0.1	H±0.1	P±0.3
KX	7.3	4.3	2.4	1.9	1.3

Unit : mm
* Externals of figure are the reference.

Explanation of part numbers

◇ Part number system e.g.: EEFKX0D331RE

EEF		KX		0D		331		RE			
Series	Product classification	Series	Code	Rated Voltage (V)	Code	Capacitance (μF)	Code	Capacitance (μF)	Code	ESR (mΩ)	Special code
KX	EEF	KX	KX	2.0	0D	120	121	330	331	3	RB
				2.5	0E	150	151	390	391	4.5	RC
				4.0	0G	180	181	470	471	9	RE
				6.3	0J	220	221			15	RF

Characteristics list

Series	Rated voltage [105 °C] (V)	Category voltage [125 °C] (V)	Capacitance (μF)	Case size (mm)			Specification		Part number	Min. Packaging Qty (pcs)
				L	W	H	Ripple current* ¹ (mA rms)	ESR* ² (mΩ max.)		
KX	2.0	1.6	330	7.3	4.3	1.9	6300	9	EEFKX0D331RE	3500
				7.3	4.3	1.9	6300	9	EEFKX0D471RE	3500
			470	7.3	4.3	1.9	8500	4.5	EEFKX0D471RC	3500
				7.3	4.3	1.9	10200	3	EEFKX0D471RB	3500
	2.5	2.0	220	7.3	4.3	1.9	6300	9	EEFKX0E221RE	3500
				7.3	4.3	1.9	6300	9	EEFKX0E331RE	3500
			390	7.3	4.3	1.9	6300	9	EEFKX0E391RE	3500
				7.3	4.3	1.9	8500	4.5	EEFKX0E391RC	3500
			470	7.3	4.3	1.9	10200	3	EEFKX0E391RB	3500
				7.3	4.3	1.9	6300	9	EEFKX0E471RE	3500
				7.3	4.3	1.9	8500	4.5	EEFKX0E471RC	3500
						7.3	4.3	1.9	10200	3
	4.0	3.2	150	7.3	4.3	1.9	5100	15	EEFKX0G151RF	3500
			180	7.3	4.3	1.9	5100	15	EEFKX0G181RF	3500
			220	7.3	4.3	1.9	5100	15	EEFKX0G221RF	3500
	6.3	5.0	120	7.3	4.3	1.9	5100	15	EEFKX0J121RF	3500
			150	7.3	4.3	1.9	5100	15	EEFKX0J151RF	3500

*1: Ripple current (100 kHz / +45 °C)

*2: ESR (100 kHz / +20 °C)

◆ Please refer to each page in this catalog for "Reflow conditions" and "Taping specifications".

Temperature coefficient of ripple current

Temperature		T ≤ 45 °C	45 °C < T ≤ 85 °C	85 °C < T ≤ 125 °C
2.0 V to 6.3 V	Coefficient	1.0	0.7	0.25

◆ Ripple current should be controlled so that surface temperature of capacitor does not exceed the category temperature.

**Conductive Polymer Aluminum
Electrolytic Capacitors**
Surface Mount Type

TX series [High temperature long life product]



Features

- Endurance 135 °C 5500 h
- Damp heat 85°C 85% 1000 h
- Low ESR (3 ~ 15 mΩ max.)
- RoHS compliance, Halogen free

Specifications

Series	TX			
Category temp. range	-55 °C to +135 °C			
Rated voltage range	2.0 V to 6.3 V			
Category voltage range	1.6 V, 2.0 V, 3.2 V, 5.0 V			
Rated cap. range	120 μF to 470 μF			
Capacitance tolerance	±20 % (120 Hz / +20 °C)			
DC leakage current	I ≤ 0.1 CV (μA) 2 minutes			
Dissipation factor (tan δ)	≤ 0.1 (120 Hz / + 20 °C)			
Surge voltage (V)	Rated voltage × 1.25 (15 °C to 35 °C)			
Endurance	+135 °C 5500 h, category voltage applied			
	Capacitance change	Within ±20 % of the initial value		
	Dissipation factor (tan δ)	≤ 2 times of the initial limit		
	DC leakage current	≤ 3 times of the initial limit		
Damp heat (Steady state)	+85 °C, 85 % RH, 1000 h, No-applied voltage			
	Capacitance change of initial measured value	2.0 V, 2.5 V	4.0 V	6.3 V
		+70 %, -20 %	+60 %, -20 %	+50 %, -20 %
	Dissipation factor (tan δ)	≤ 2 times of the initial limit		
DC leakage current	≤ 5 times of the initial limit			

Marking

Capacitance (μF) Polarity (Positive)

Lot No. R. voltage code 2D code *1

R. voltage code		Unit : V	
d	2.0	g	4.0
e	2.5	j	6.3

*1: Internal management information

Dimensions (not to scale)

Series	L±0.2	W1±0.2	W2±0.1	H±0.1	P±0.3
TX	7.3	4.3	2.4	1.9	1.3

Unit : mm

* Externals of figure are the reference.

Explanation of part numbers

◇ Part number system e.g.: EEFTX0D331RE

EEF		TX		0D		331		RE			
Series	Product classification	Series	Code	Rated Voltage (V)	Code	Capacitance (μF)	Code	Capacitance (μF)	Code	ESR (mΩ)	Special code
TX	EEF	TX	TX	2.0	0D	120	121	330	331	3	RB
				2.5	0E	150	151	390	391	4.5	RC
				4.0	0G	180	181	470	471	9	RE
				6.3	0J	220	221			15	RF

Characteristics list

Series	Rated voltage [105 °C] (V)	Category voltage [135 °C] (V)	Capacitance (μF)	Case size (mm)			Specification		Part number	Min. Packaging Qty (pcs)
				L	W	H	Ripple current* ¹ (mA rms)	ESR* ² (mΩ max.)		
TX	2.0	1.6	330	7.3	4.3	1.9	6300	9	EEFTX0D331RE	3500
				7.3	4.3	1.9	6300	9	EEFTX0D471RE	3500
			470	7.3	4.3	1.9	8500	4.5	EEFTX0D471RC	3500
				7.3	4.3	1.9	10200	3	EEFTX0D471RB	3500
	2.5	2.0	220	7.3	4.3	1.9	6300	9	EEFTX0E221RE	3500
				7.3	4.3	1.9	6300	9	EEFTX0E331RE	3500
			390	7.3	4.3	1.9	6300	9	EEFTX0E391RE	3500
				7.3	4.3	1.9	8500	4.5	EEFTX0E391RC	3500
				7.3	4.3	1.9	10200	3	EEFTX0E391RB	3500
	4.0	3.2	150	7.3	4.3	1.9	5100	15	EEFTX0G151RF	3500
			180	7.3	4.3	1.9	5100	15	EEFTX0G181RF	3500
			220	7.3	4.3	1.9	5100	15	EEFTX0G221RF	3500
	6.3	5.0	120	7.3	4.3	1.9	5100	15	EEFTX0J121RF	3500
			150	7.3	4.3	1.9	5100	15	EEFTX0J151RF	3500

*1: Ripple current (100 kHz / +45 °C)

*2: ESR (100 kHz / +20 °C)

◆ Please refer to each page in this catalog for "Reflow conditions" and "Taping specifications".

Temperature coefficient of ripple current

Temperature		T ≤ 45 °C	45 °C < T ≤ 85 °C	85 °C < T ≤ 135 °C
2.0 V to 6.3 V	Coefficient	1.0	0.7	0.25

◆ Ripple current should be controlled so that surface temperature of capacitor does not exceed the category temperature.

**Conductive Polymer Aluminum
Electrolytic Capacitors**
Surface Mount Type

JZ series [High temperature long life product]

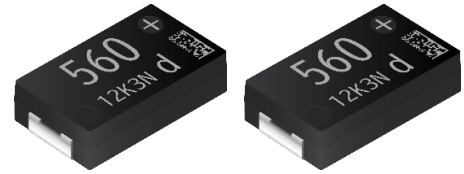

Features

- Endurance 125 °C 3000 h
- Damp heat 85°C 85% 1000 h
- Low ESR (3 to 9 mΩ)
- RoHS compliance, Halogen free

Specifications

Series	JZ	
Category temp. range	-55 °C to +125 °C	
Rated voltage range	2.0 V	
Category voltage range	1.6 V	
Rated cap. range	560 μF	
Capacitance tolerance	±20 % (120 Hz / +20 °C)	
DC leakage current	I ≤ 0.1 CV (μA) 2 minutes	
Dissipation factor (tan δ)	≤ 0.1 (120 Hz / +20 °C)	
Surge voltage (V)	Rated voltage × 1.25 (15 °C to 35 °C)	
Endurance	+125 °C 3000 h, category voltage applied	
	Capacitance change	Within ±20 % of the initial value
	Dissipation factor (tan δ)	≤ 2 times of the initial limit
	DC leakage current	≤ 3 times of the initial limit
Damp heat (Steady state)	+85 °C, 85 % RH, 1000 h, No-applied voltage	
	Capacitance change of initial measured value	2.0 V +70 %, -20 %
	Dissipation factor (tan δ)	≤ 2 times of the initial limit
	DC leakage current	≤ 5 times of the initial limit

Marking

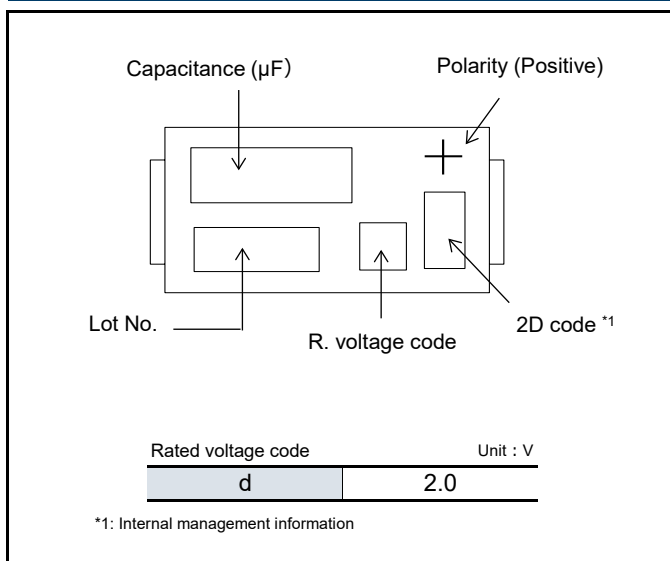

Dimensions (not to scale)

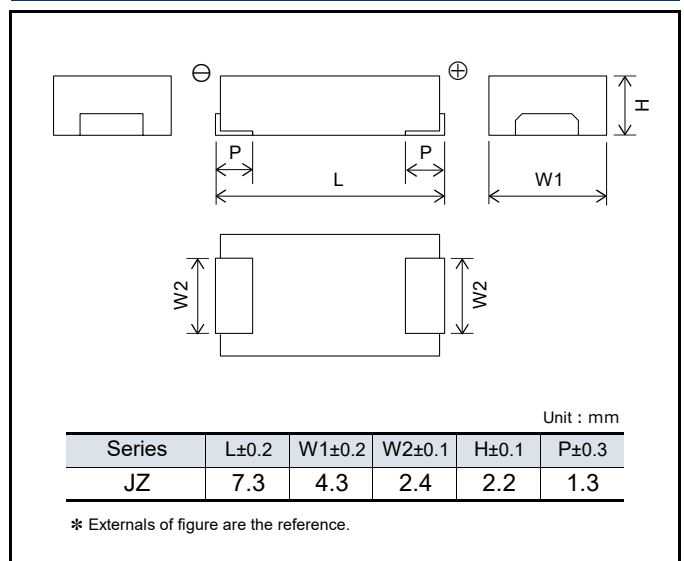

Explanation of part numbers

◇ Part number system e.g.: EEFJZ0D561RE

EEF		JZ		0D		561		RE	
Series	Product classification	Series	Code	Rated Voltage (V)	Code	Capacitance (μF)	Code	ESR (mΩ)	Special code
JZ	EEF	JZ	JZ	2.0	0D	560	561	3	RB
								4.5	RC
								9	RE

Characteristics list

Series	Rated voltage [105 °C] (V)	Category voltage [125 °C] (V)	Capacitance (μF)	Case size (mm)			Specification		Part number	Min. Packaging Q'ty (pcs)
				L	W	H	Ripple current ^{*1} (mA rms)	ESR ^{*2} (mΩ max.)		
JZ	2.0	1.6	560	7.3	4.3	2.2	6300	9	EEFJZ0D561RE	3000
				7.3	4.3	2.2	8500	4.5	EEFJZ0D561RC	3000
				7.3	4.3	2.2	10200	3	EEFJZ0D561RB	3000

*1: Ripple current (100 kHz / +45 °C)

*2: ESR (100 kHz / +20 °C)

◆ Please refer to each page in this catalog for "Reflow conditions" and "Taping specifications".

Temperature coefficient of ripple current

Temperature		T ≤ 45 °C	45 °C < T ≤ 85 °C	85 °C < T ≤ 125 °C
2.0 V	Coefficient	1.0	0.7	0.25

◆ Ripple current should be controlled so that surface temperature of capacitor does not exceed the category temperature.

**Conductive Polymer Aluminum
Electrolytic Capacitors**
Surface Mount Type

KZ series [High temperature long life product]

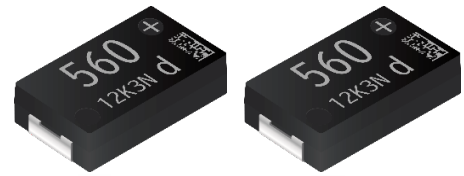

Features

- Endurance 125 °C 5500 h
- Damp heat 85°C 85% 1000 h
- Low ESR (3 to 9 mΩ)
- RoHS compliance, Halogen free

Specifications

Series	KZ	
Category temp. range	-55 °C to +125 °C	
Rated voltage range	2.0 V	
Category voltage range	1.6 V	
Rated cap. range	560 μF	
Capacitance tolerance	±20 % (120 Hz / +20 °C)	
DC leakage current	I ≤ 0.1 CV (μA) 2 minutes	
Dissipation factor (tan δ)	≤ 0.1 (120 Hz / + 20 °C)	
Surge voltage (V)	Rated voltage × 1.25 (15 °C to 35 °C)	
Endurance	+125 °C 5500 h, category voltage applied	
	Capacitance change	Within ±20 % of the initial value
	Dissipation factor (tan δ)	≤ 2 times of the initial limit
	DC leakage current	≤ 3 times of the initial limit
Damp heat (Steady state)	+85 °C, 85 % RH, 1000 h, No-applied voltage	
	Capacitance change of initial measured value	2.0 V +70 %, -20 %
	Dissipation factor (tan δ)	≤ 2 times of the initial limit
	DC leakage current	≤ 5 times of the initial limit

Marking

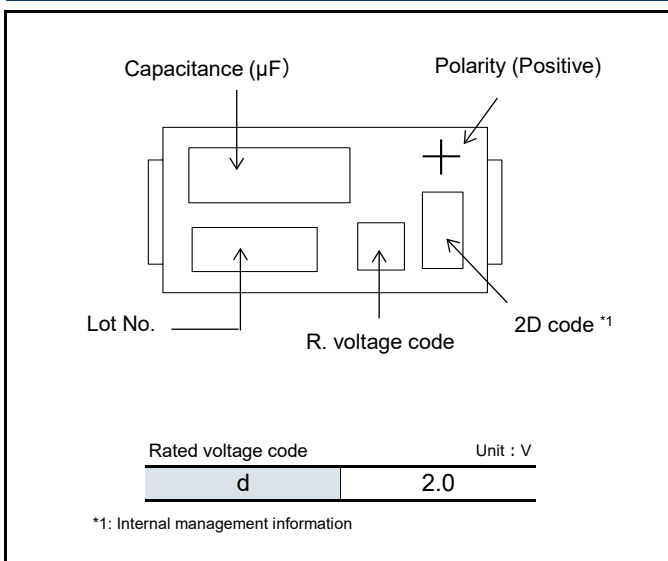

Dimensions (not to scale)

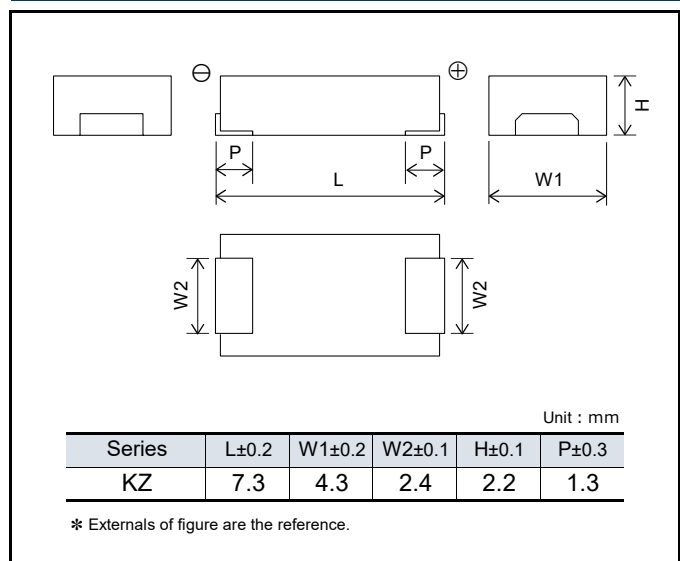

Explanation of part numbers

◇ Part number system e.g.: EEFKZ0D561RE

EEF		KZ		0D		561		RE	
Series	Product classification	Series	Code	Rated Voltage (V)	Code	Capacitance (μF)	Code	ESR (mΩ)	Special code
KZ	EEF	KZ	KZ	2.0	0D	560	561	3	RB
								4.5	RC
								9	RE

Characteristics list

Series	Rated voltage [105 °C] (V)	Category voltage [125 °C] (V)	Capacitance (μF)	Case size (mm)			Specification		Part number	Min. Packaging Q'ty (pcs)
				L	W	H	Ripple current*1 (mA rms)	ESR*2 (mΩ max.)		
KZ	2.0	1.6	560	7.3	4.3	2.2	6300	9	EEFKZ0D561RE	3000
				7.3	4.3	2.2	8500	4.5	EEFKZ0D561RC	3000
				7.3	4.3	2.2	10200	3	EEFKZ0D561RB	3000

*1: Ripple current (100 kHz / +45 °C)

*2: ESR (100 kHz / +20 °C)

◆ Please refer to each page in this catalog for "Reflow conditions" and "Taping specifications".

Temperature coefficient of ripple current

Temperature		T ≤ 45 °C	45 °C < T ≤ 85 °C	85 °C < T ≤ 125 °C
2.0 V	Coefficient	1.0	0.7	0.25

◆ Ripple current should be controlled so that surface temperature of capacitor does not exceed the category temperature.

**Conductive Polymer Aluminum
Electrolytic Capacitors**
Surface Mount Type

TZ series [High temperature long life product]

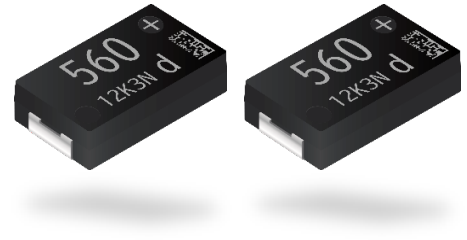

Features

- Endurance 135 °C 5500 h
- Damp heat 85°C 85% 1000 h
- Low ESR (3 to 9 mΩ)
- RoHS compliance, Halogen free

Specifications

Series	TZ	
Category temp. range	-55 °C to +135 °C	
Rated voltage range	2.0 V	
Category voltage range	1.6 V	
Rated cap. range	560 μF	
Capacitance tolerance	±20 % (120 Hz / +20 °C)	
DC leakage current	I ≤ 0.1 CV (μA) 2 minutes	
Dissipation factor (tan δ)	≤ 0.1 (120 Hz / + 20 °C)	
Surge voltage (V)	Rated voltage × 1.25 (15 °C to 35 °C)	
Endurance	+135 °C 5500 h, category voltage applied	
	Capacitance change	Within ±20 % of the initial value
	Dissipation factor (tan δ)	≤ 2 times of the initial limit
	DC leakage current	≤ 3 times of the initial limit
Damp heat (Steady state)	+85 °C, 85 % RH, 1000 h, No-applied voltage	
	Capacitance change of initial measured value	2.0 V +70 %, -20 %
	Dissipation factor (tan δ)	≤ 2 times of the initial limit
	DC leakage current	≤ 5 times of the initial limit

Marking

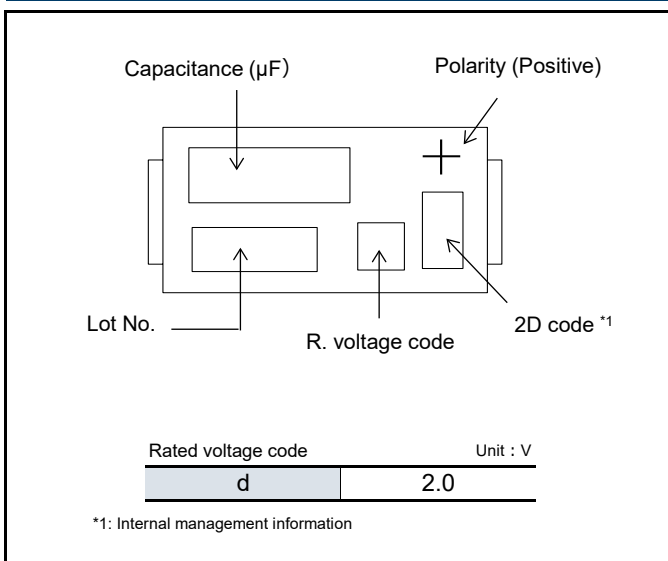

Dimensions (not to scale)

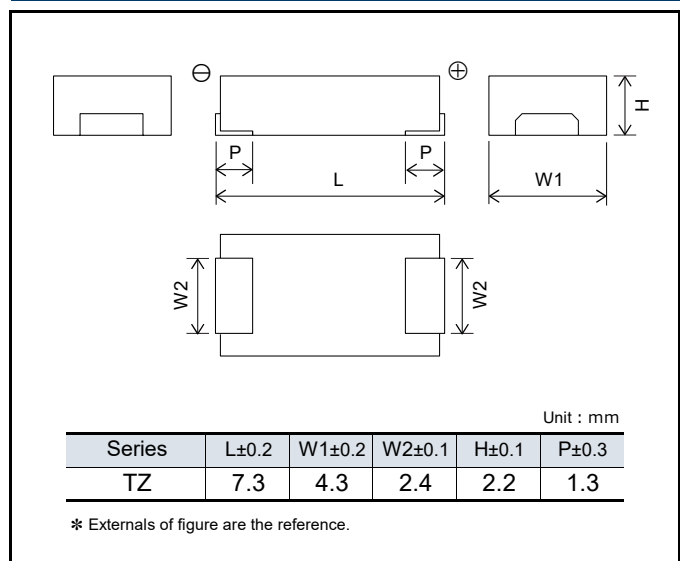

Explanation of part numbers

◇ Part number system e.g.: EEFTZ0D561RE

EEF		TZ		0D		561		RE	
Series	Product classification	Series	Code	Rated Voltage (V)	Code	Capacitance (μF)	Code	ESR (mΩ)	Special code
TZ	EEF	TZ	TZ	2.0	0D	560	561	3	RB
								4.5	RC
								9	RE

Characteristics list

Series	Rated voltage [105 °C] (V)	Category voltage [135 °C] (V)	Capacitance (μF)	Case size (mm)			Specification		Part number	Min. Packaging Q'ty (pcs)
				L	W	H	Ripple current* ¹ (mA rms)	ESR* ² (mΩ max.)		
TZ	2.0	1.6	560	7.3	4.3	2.2	6300	9	EEFTZ0D561RE	3000
				7.3	4.3	2.2	8500	4.5	EEFTZ0D561RC	3000
				7.3	4.3	2.2	10200	3	EEFTZ0D561RB	3000

*1: Ripple current (100 kHz / +45 °C)

*2: ESR (100 kHz / +20 °C)

◆ Please refer to each page in this catalog for "Reflow conditions" and "Taping specifications".

Temperature coefficient of ripple current

Temperature		T ≤ 45 °C	45 °C < T ≤ 85 °C	85 °C < T ≤ 135 °C
2.0 V	Coefficient	1.0	0.7	0.25

◆ Ripple current should be controlled so that surface temperature of capacitor does not exceed the category temperature.

• 2 to 6.3 V : On sale
• 10 to 35 V : Not recommended for new design
※ Click [here](#) for Replacement (10 to 35 V)



Conductive Polymer Aluminum Electrolytic Capacitors
Surface Mount Type
CS/CT/CX series

When SP-Cap is designed to be used under constant high load application such as represented in but not limited to the following products such as AI servers, switches, routers, and base stations, we strongly recommend using the long-life series (JX/KX/TX series) and avoid choosing standard series (CS/CT/CX series).

Features

- High voltage (35 V max.)
- Low profile (Height 1.0 mm max.)
- High ripple current (5600 mA rms max.)
- RoHS compliance, Halogen free

Specifications

Series	CS	CT	CX	
Category temp. range	-55 °C to +105 °C			
Rated voltage range	4.0 V to 35 V		2.0 V to 35 V	
Rated cap. range	10 µF to 120 µF	15 µF to 180 µF	15 µF to 560 µF	
Capacitance tolerance	±20 % (120 Hz / +20 °C)			
DC leakage current	I ≤ 0.1 CV(µA) [2.0 V to 6.3 V, 2 min], I ≤ 0.3 CV(µA) [10 V to 35 V, 2 min]			
Dissipation factor (tan δ)	≤ 0.06 (120 Hz / + 20 °C)			
Surge voltage (V)	Rated voltage × 1.25 [2.0 V to 16 V], × 1.15 [20 V to 35 V] (15 °C to 35 °C)			
Endurance	+105 °C 2000 h, rated voltage applied			
	Capacitance change	Within ±20 % of the initial value		
	Dissipation factor (tan δ)	≤ 2 times of the initial limit		
	DC leakage current	≤ 3 times of the initial limit : 2.0 V to 6.3 V Within the initial limit : 10 V to 35 V		
Damp heat (Steady state)	+60 °C, 90 % RH, 500 h, No-applied voltage			
	Capacitance change of initial measurd value	2.0 V to 2.5 V +70 %, -20 %	4.0 V, 10 V to 35 V +60 %, -20 %	6.3 V +50 %, -20 %
	Dissipation factor (tan δ)	≤ 2 times of the initial limit		
	DC leakage current	Within the initial limit : 2.0 V to 6.3 V ≤ 3 times of the initial limit : 10 V to 35 V		

Marking

Capacitance (µF) Polarity bar (Positive)

Lot No. R. voltage code

R. voltage code	Unit : V
d	2.0
e	2.5
g	4.0
j	6.3
A	10
C	16
D	20
E	25
V	35

Dimensions (not to scale)

Unit : mm					
Series	L±0.2	W1±0.2	W2±0.1	H±0.1	P±0.3
CS	7.3	4.3	2.4	1.1	1.3
CT	7.3	4.3	2.4	1.4	1.3
CX	7.3	4.3	2.4	1.9	1.3

* Externals of figure are the reference.

Explanation of part numbers

◇ **Part number system** e.g.: EEFC0G121R

EEF		CS		0G		121		R			
Series	Product classification	Series	Code	Rated Voltage (V)	Code	Capacitance (μF)	Code	Capacitance (μF)	Code	ESR (mΩ)	Special code
CS	EEF	CS	CS	2.0	0D	10	100	150	151	15 (2.0 to 6.3 V) 40 (10 to 35 V)	R
CT		CT	2.5	0E	15	150	180	181			
CX		CX	4.0	0G	22	220	220	221	220	221	12
				6.3	0J	33	330	270	271		
				10	1A	47	470	330	331		
				16	1C	56	560	390	391		
				20	1D	68	680	470	471		
				25	1E	100	101	560	561		
				35	1V	120	121				

Characteristics list

■ **2.0 V to 6.3 V**

Series	Rated voltage (V)	Capacitance (μF)	Case size (mm)			Specification		Part number	Min. Packaging Q'ty ^{*3} (pcs)
			L	W	H	Ripple current ^{*1} (mA rms)	ESR ^{*2} (mΩ max.)		
CS	4.0	120	7.3	4.3	1.1	5100	15	EEFC0G121R	3500
	6.3	68	7.3	4.3	1.1	5100	15	EEFC0J680R	3500
CT	4.0	180	7.3	4.3	1.4	5100	15	EEFC0G181R	3500
	6.3	100	7.3	4.3	1.4	5100	15	EEFC0J101R	3500
CX	2.0	220	7.3	4.3	1.9	5100	15	EEFC0D221R	3500
		270	7.3	4.3	1.9	5600	12	EEFC0D271XR	3500
		330	7.3	4.3	1.9	5100	15	EEFC0D331R	3500
			7.3	4.3	1.9	5600	12	EEFC0D331XR	3500
		390	7.3	4.3	1.9	5100	15	EEFC0D391R	3500
		470	7.3	4.3	1.9	5100	15	EEFC0D471R	3500
	560	7.3	4.3	1.9	5100	15	EEFC0D561R	3500	
	2.5	220	7.3	4.3	1.9	5100	15	EEFC0E221R	3500
		330	7.3	4.3	1.9	5100	15	EEFC0E331R	3500
		390	7.3	4.3	1.9	5100	15	EEFC0E391R	3500
		470	7.3	4.3	1.9	5100	15	EEFC0E471R	3500
	4.0	150	7.3	4.3	1.9	5100	15	EEFC0G151R	3500
			7.3	4.3	1.9	5100	15	EEFC0G181R	3500
		180	7.3	4.3	1.9	5600	12	EEFC0G181XR	3500
			7.3	4.3	1.9	5100	15	EEFC0G221R	3500
		220	7.3	4.3	1.9	5600	12	EEFC0G221XR	3500
			7.3	4.3	1.9	5100	15	EEFC0G271R	3500
		330	7.3	4.3	1.9	5100	15	EEFC0G331R	3500
		6.3	100	7.3	4.3	1.9	5100	15	EEFC0J101R
	7.3			4.3	1.9	5100	15	EEFC0J121R	3500
	150		7.3	4.3	1.9	5100	15	EEFC0J151R	3500
			7.3	4.3	1.9	5600	12	EEFC0J151XR	3500
	180		7.3	4.3	1.9	5100	15	EEFC0J181R	3500
			7.3	4.3	1.9	5100	15	EEFC0J221R	3500

*1: Ripple current (100 kHz / +45 °C)

*2: ESR (100 kHz / +20 °C)

*3: Please contact us when 500 pcs packing is necessary.

◆ Please refer to each page in this catalog for "Reflow conditions" and "Taping specifications".

Temperature coefficient of ripple current

Temperature		T ≤ 45 °C	45 °C < T ≤ 85 °C	85 °C < T ≤ 105 °C
2.0 V to 6.3 V	Coefficient	1.0	0.7	0.25

◆ Ripple current should be controlled so that surface temperature of capacitor does not exceed the category temperature.

Characteristics list

■ 10 V to 35 V

Not Recommended for New Design

For replacement

Series	Rated voltage (V)	Capacitance (μF)	Case size (mm)			Specification		Part number	Min. Packaging Q'ty ^{*3} (pcs)
			L	W	H	Ripple current ^{*1} (mA rms)	ESR ^{*2} (mΩ max.)		
CS	10	47	7.3	4.3	1.1	3200	40	EEFCS1A470R	3500
	16	15	7.3	4.3	1.1	3200	40	EEFCS1C150R	3500
		22	7.3	4.3	1.1	3200	40	EEFCS1C220R	3500
		33	7.3	4.3	1.1	3200	40	EEFCS1C330R	3500
	20	10	7.3	4.3	1.1	3200	40	EEFCS1D100R	3500
		15	7.3	4.3	1.1	3200	40	EEFCS1D150R	3500
		22	7.3	4.3	1.1	3200	40	EEFCS1D220R	3500
	25	10	7.3	4.3	1.1	3200	40	EEFCS1E100R	3500
		15	7.3	4.3	1.1	3200	40	EEFCS1E150R	3500
	35	10	7.3	4.3	1.1	3200	40	EEFCS1V100R	3500
CT	10	68	7.3	4.3	1.4	3200	40	EEFCT1A680R	3500
	16	47	7.3	4.3	1.4	3200	40	EEFCT1C470R	3500
		33	7.3	4.3	1.4	3200	40	EEFCT1D330R	3500
	20	47	7.3	4.3	1.4	3200	40	EEFCT1D470R	3500
		22	7.3	4.3	1.4	3200	40	EEFCT1E220R	3500
	35	15	7.3	4.3	1.4	3200	40	EEFCT1V150R	3500
CX	10	47	7.3	4.3	1.9	3200	40	EEFCX1A470R	3500
		68	7.3	4.3	1.9	3200	40	EEFCX1A680R	3500
		100	7.3	4.3	1.9	3200	40	EEFCX1A101R	3500
	16	15	7.3	4.3	1.9	3200	40	EEFCX1C150R	3500
		22	7.3	4.3	1.9	3200	40	EEFCX1C220R	3500
		33	7.3	4.3	1.9	3200	40	EEFCX1C330R	3500
		47	7.3	4.3	1.9	3200	40	EEFCX1C470R	3500
		68	7.3	4.3	1.9	3200	40	EEFCX1C680R	3500
		22	7.3	4.3	1.9	3200	40	EEFCX1D220R	3500
	20	33	7.3	4.3	1.9	3200	40	EEFCX1D330R	3500
		47	7.3	4.3	1.9	3200	40	EEFCX1D470R	3500
		56	7.3	4.3	1.9	3200	40	EEFCX1D560R	3500
		15	7.3	4.3	1.9	3200	40	EEFCX1E150R	3500
	25	22	7.3	4.3	1.9	3200	40	EEFCX1E220R	3500
		33	7.3	4.3	1.9	3200	40	EEFCX1E330R	3500
		15	7.3	4.3	1.9	3200	40	EEFCX1V150R	3500
	35	22	7.3	4.3	1.9	3200	40	EEFCX1V220R	3500

*1: Ripple current (100 kHz / +45 °C)

*2: ESR (100 kHz / +20 °C)

*3: Please contact us when 500 pcs packing is necessary.

◆ Please refer to each page in this catalog for "Reflow conditions" and "Taping specifications".

Temperature coefficient of ripple current

Temperature		T ≤ 45 °C	45 °C < T ≤ 85 °C	85 °C < T ≤ 105 °C
10 V to 35 V	Coefficient	1.0	0.8	0.5

◆ Ripple current should be controlled so that surface temperature of capacitor does not exceed the category temperature.

**Conductive Polymer Aluminum
Electrolytic Capacitors**
Surface Mount Type

SX series [Low ESR products]

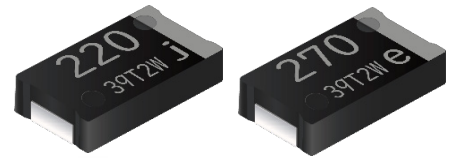

When SP-Cap is designed to be used under constant high load application such as represented in but not limited to the following products such as AI servers, switches, routers, and base stations, we strongly recommend using the long-life series (JX/KX/TX series) and avoid choosing standard series (SX series).

Features

- Large capacitance (560 μ F max.)
- Low ESR (4.5 m Ω to 9 m Ω max.)
- High ripple current (8500 mA rms max.)
- RoHS compliance, Halogen free

Specifications

Series	SX			
Category temp. range	-55 °C to +105 °C			
Rated voltage range	2.0 V to 6.3 V			
Rated cap. range	82 μ F to 560 μ F			
Capacitance tolerance	\pm 20 % (120 Hz / +20 °C)			
DC leakage current	$I \leq 0.1$ CV (μ A) 2 minutes			
Dissipation factor (tan δ)	≤ 0.06 (120 Hz / + 20 °C)			
Surge voltage (V)	Rated voltage \times 1.25 (15 °C to 35 °C)			
Endurance	+105 °C 2000 h, rated voltage applied			
	Capacitance change	Within \pm 20 % of the initial value		
	Dissipation factor (tan δ)	≤ 2 times of the initial limit		
	DC leakage current	≤ 3 times of the initial limit		
Damp heat (Steady state)	+60 °C, 90 % RH, 500 h, No-applied voltage			
	Capacitance change of initial measured value	2.0 V to 2.5 V	4.0 V	6.3 V
		+70 %, -20 %	+60 %, -20 %	+50 %, -20 %
	Dissipation factor (tan δ)	≤ 2 times of the initial limit		
DC leakage current	Within the initial limit			

Marking

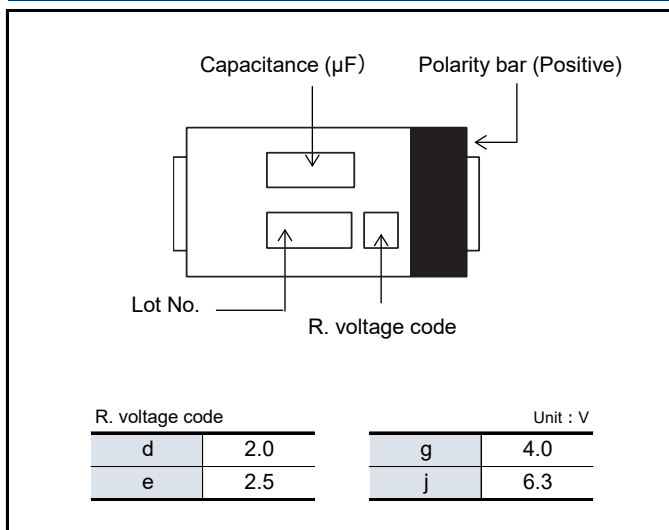

Dimensions (not to scale)

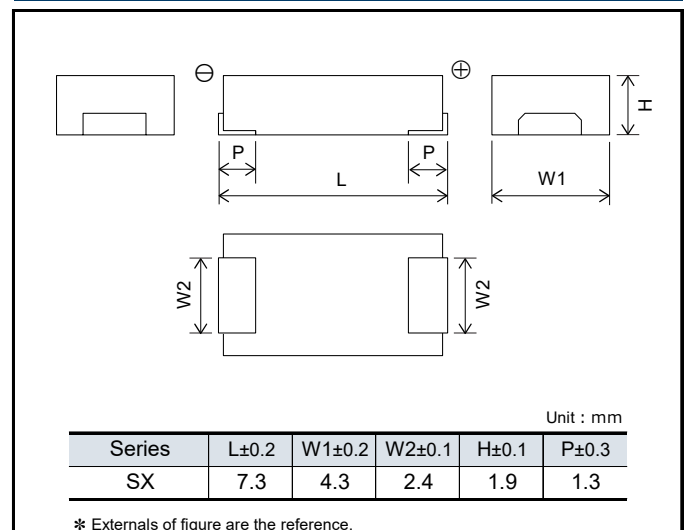

Explanation of part numbers

◆ **Part number system** e.g.: EEFSX0D271XE

EEF		SX		OD		271		XE			
Series	Product classification	Series	Code	Rated Voltage (V)	Code	Capacitance (µF)	Code	Capacitance (µF)	Code	ESR (mΩ)	Special code
SX	EEF	SX	SX	2.0	OD	82	820	270	271	4.5	E4
				2.5	OE	100	101	330	331	6	XE
				4.0	OG	120	121	390	391	7	E7
				6.3	OJ	150	151	470	471	9	ER
						180	181	560	561		
						220	221				

Characteristics list

Series	Rated voltage (V)	Capacitance (µF)	Case size (mm)			Specification		Part number	Min. Packaging Q'ty ^{*3} (pcs)		
			L	W	H	Ripple current ^{*1} (mA rms)	ESR ^{*2} (mΩ max.)				
SX	2.0	180	7.3	4.3	1.9	6300	9	EEFSX0D181ER	3500		
		220	7.3	4.3	1.9	6300	9	EEFSX0D221ER	3500		
		270	7.3	4.3	1.9	6300	9	EEFSX0D271ER	3500		
			7.3	4.3	1.9	7500	6	EEFSX0D271XE	3500		
		330	7.3	4.3	1.9	8500	4.5	EEFSX0D271E4	3500		
			7.3	4.3	1.9	6300	9	EEFSX0D331ER	3500		
			7.3	4.3	1.9	7500	6	EEFSX0D331XE	3500		
		390	7.3	4.3	1.9	8500	4.5	EEFSX0D331E4	3500		
			7.3	4.3	1.9	6300	9	EEFSX0D391ER	3500		
			7.3	4.3	1.9	7500	6	EEFSX0D391XE	3500		
		470	7.3	4.3	1.9	8500	4.5	EEFSX0D391E4	3500		
			7.3	4.3	1.9	6300	9	EEFSX0D471ER	3500		
			7.3	4.3	1.9	7500	6	EEFSX0D471XE	3500		
				7.3	4.3	1.9	8500	4.5	EEFSX0D471E4	3500	
				560	7.3	4.3	1.9	8500	4.5	EEFSX0D561E4	3500
		2.5	150	7.3	4.3	1.9	6300	9	EEFSX0E151ER	3500	
			180	7.3	4.3	1.9	6300	9	EEFSX0E181ER	3500	
			220	7.3	4.3	1.9	6300	9	EEFSX0E221ER	3500	
	7.3			4.3	1.9	7000	7	EEFSX0E221E7	3500		
	270		7.3	4.3	1.9	7000	7	EEFSX0E271E7	3500		
			7.3	4.3	1.9	6300	9	EEFSX0E331ER	3500		
	330		7.3	4.3	1.9	7500	6	EEFSX0E331XE	3500		
			7.3	4.3	1.9	8500	4.5	EEFSX0E331E4	3500		
			7.3	4.3	1.9	6300	9	EEFSX0E391ER	3500		
	390		7.3	4.3	1.9	7500	6	EEFSX0E391XE	3500		
			7.3	4.3	1.9	8500	4.5	EEFSX0E391E4	3500		
			7.3	4.3	1.9	6300	9	EEFSX0E471ER	3500		
	470		7.3	4.3	1.9	7500	6	EEFSX0E471XE	3500		
			7.3	4.3	1.9	8500	4.5	EEFSX0E471E4	3500		
			82	7.3	4.3	1.9	6300	9	EEFSX0G820ER	3500	
	4.0		100	7.3	4.3	1.9	6300	9	EEFSX0G101ER	3500	
			150	7.3	4.3	1.9	6300	9	EEFSX0G151ER	3500	
				7.3	4.3	1.9	7000	7	EEFSX0G151E7	3500	
		180	7.3	4.3	1.9	6300	9	EEFSX0G181ER	3500		
		220	7.3	4.3	1.9	6300	9	EEFSX0G221ER	3500		
		270	7.3	4.3	1.9	6300	9	EEFSX0G271ER	3500		
7.3			4.3	1.9	6300	9	EEFSX0G331ER	3500			
		7.3	4.3	1.9	7500	6	EEFSX0G331XE	3500			
6.3	120	7.3	4.3	1.9	7000	7	EEFSX0J121E7	3500			
	150	7.3	4.3	1.9	6300	9	EEFSX0J151ER	3500			
	180	7.3	4.3	1.9	6300	9	EEFSX0J181ER	3500			
	220	7.3	4.3	1.9	6300	9	EEFSX0J221ER	3500			

*1: Ripple current (100 kHz / +45 °C) *2: ESR (100 kHz / +20 °C) *3: Please contact us when 500 pcs packing is necessary.

◆ Please refer to each page in this catalog for "Reflow conditions" and "Taping specifications".

Temperature coefficient of ripple current

Temperature		T ≤ 45 °C	45 °C < T ≤ 85 °C	85 °C < T ≤ 105 °C
2.0 V to 6.3 V	Coefficient	1.0	0.7	0.25

◆ Ripple current should be controlled so that surface temperature of capacitor does not exceed the category temperature.

**Conductive Polymer Aluminum
Electrolytic Capacitors**
Surface Mount Type

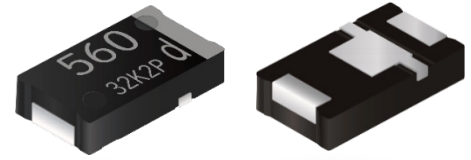

GX/GX-L series [Super low ESR products]

When SP-Cap is designed to be used under constant high load application such as represented in but not limited to the following products such as AI servers, switches, routers, and base stations, we strongly recommend using the long-life series (JX/KX/TX series) and avoid choosing standard series (GX/GX-L series).

Features

- Large capacitance (560 μ F max.)
- Super Low ESR (3 m Ω max.)
- Low ESL (3-terminals : 50 % less than 2-terminals) [Suffix : L]
- High ripple current (10200 mA rms max.)
- RoHS compliance, Halogen free

Specifications

Series	GX	
Category temp. range	-55 °C to +105 °C	
Rated voltage range	2.0 V to 2.5 V	
Rated cap. range	330 μ F to 560 μ F	
Capacitance tolerance	± 20 % (120 Hz / +20 °C)	
DC leakage current	$I \leq 0.1 CV$ (μ A) 2 minutes	
Dissipation factor (tan δ)	≤ 0.06 (120 Hz / + 20 °C)	
Surge voltage (V)	Rated voltage \times 1.25 (15 °C to 35 °C)	
Endurance	+105 °C 2000 h, rated voltage applied	
	Capacitance change	Within ± 20 % of the initial value
	Dissipation factor (tan δ)	≤ 2 times of the initial limit
	DC leakage current	≤ 3 times of the initial limit
Damp heat (Steady state)	+60 °C, 90 % RH, 500 h, No-applied voltage	
	Capacitance change of initial measurd value	2.0 V to 2.5 V +70 %, -20 %
	Dissipation factor (tan δ)	≤ 2 times of the initial limit
	DC leakage current	Within the initial limit

Marking

R. voltage code	Unit : V
d	2.0
e	2.5

Dimensions (not to scale)

Series	Unit : mm				
	L ± 0.2	W1 ± 0.2	W2 ± 0.1	H ± 0.1	P ± 0.3
GX	7.3	4.3	2.4	1.9	1.3

Series	Unit : mm							
	L ± 0.2	W1 ± 0.2	W2 ± 0.1	H ± 0.1	P1 ± 0.3	P2 ± 0.1	P3 ± 0.2	P4 ± 0.2
GX-L	7.3	4.3	2.4	1.9	1.3	1.1	0.7	1.4

* Externals of figure are the reference.

Explanation of part numbers

◇ Part number system e.g.: EEFGX0D331R

EEF		GX		0D		331		R	
Series	Product classification	Series	Code	Rated Voltage (V)	Code	Capacitance (μF)	Code	ESR (mΩ)	Special code
GX	EEF	GX	GX	2.0	0D	330	331	3	L, R
				2.5	0E	470	471		
						560	561		

Characteristics list

Series	Rated voltage (V)	Capacitance (μF)	Case size (mm)			Specification		The number of terminals		Part number	Min. Packaging Q'ty ^{*3} (pcs)	
			L	W	H	Ripple current ^{*1} (mA rms)	ESR ^{*2} (mΩ max.)	2	3			
GX	2.0	330	7.3	4.3	1.9	10200	3	○		EEFGX0D331R	3500	
			7.3	4.3	1.9	10200	3	○		EEFGX0D471R	3500	
		470	7.3	4.3	1.9	10200	3		○	EEFGX0D471L	3500	
			560	7.3	4.3	1.9	10200	3	○		EEFGX0D561R	3500
				7.3	4.3	1.9	10200	3		○	EEFGX0D561L	3500
	2.5	330	7.3	4.3	1.9	10200	3	○		EEFGX0E331R	3500	
			470	7.3	4.3	1.9	10200	3	○		EEFGX0E471R	3500
		7.3		4.3	1.9	10200	3		○	EEFGX0E471L	3500	

*1: Ripple current (100 kHz / +45 °C)

*2: ESR (100 kHz / +20 °C)

*3: Please contact us when 500 pcs packing is necessary.

◆ Please refer to each page in this catalog for "Reflow conditions" and "Taping specifications".

Temperature coefficient of ripple current

Temperature		T ≤ 45 °C	45 °C < T ≤ 85 °C	85 °C < T ≤ 105 °C
2.0 V to 2.5 V	Coefficient	1.0	0.7	0.25

◆ Ripple current should be controlled so that surface temperature of capacitor does not exceed the category temperature.

**Conductive Polymer Aluminum
Electrolytic Capacitors
Surface Mount Type**

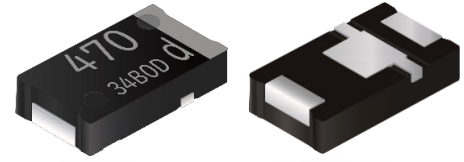

LX series [Low ESR / Low ESL products]

When SP-Cap is designed to be used under constant high load application such as represented in but not limited to the following products such as AI servers, switches, routers, and base stations, we strongly recommend using the long-life series (JX/KX/TX series) and avoid choosing standard series (LX series).

Features

- Large capacitance (560 μ F max.)
- Low ESR (4.5 m Ω , 6 m Ω max.)
- Low ESL (3-terminals : 50 % less than 2-terminals)
- High ripple current (8500 mA rms max.)
- RoHS compliance, Halogen free

Specifications

Series	LX	
Category temp. range	-55 °C to +105 °C	
Rated voltage range	2.0 V to 2.5 V	
Rated cap. range	330 μ F to 560 μ F	
Capacitance tolerance	\pm 20 % (120 Hz / +20 °C)	
DC leakage current	$I \leq 0.1 CV$ (μ A) 2 minutes	
Dissipation factor (tan δ)	≤ 0.06 (120 Hz / +20 °C)	
Surge voltage (V)	Rated voltage \times 1.25 (15 °C to 35 °C)	
Endurance	+105 °C 2000 h, rated voltage applied	
	Capacitance change	Within \pm 20 % of the initial value
	Dissipation factor (tan δ)	≤ 2 times of the initial limit
	DC leakage current	≤ 3 times of the initial limit
Damp heat (Steady state)	+60 °C, 90 % RH, 500 h, No-applied voltage	
	Capacitance change of initial measurd value	2.0 V to 2.5 V +70 %, -20 %
	Dissipation factor (tan δ)	≤ 2 times of the initial limit
	DC leakage current	Within the initial limit

Marking **Dimensions (not to scale)**

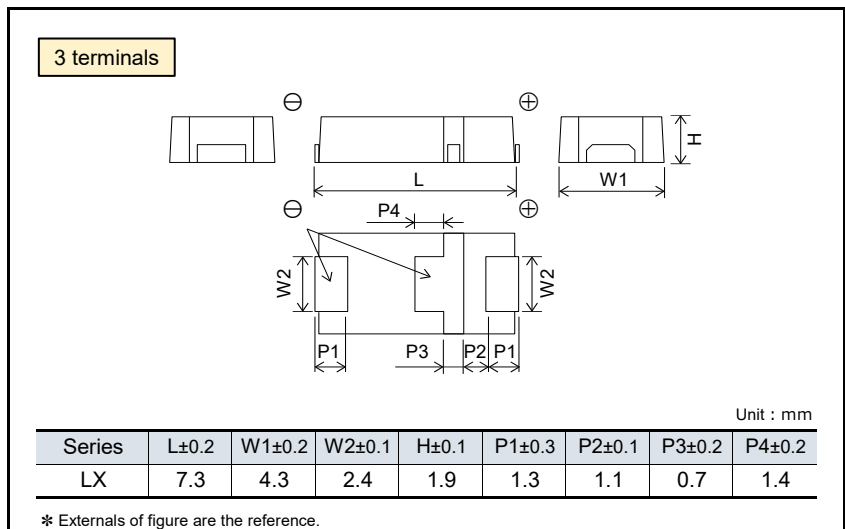
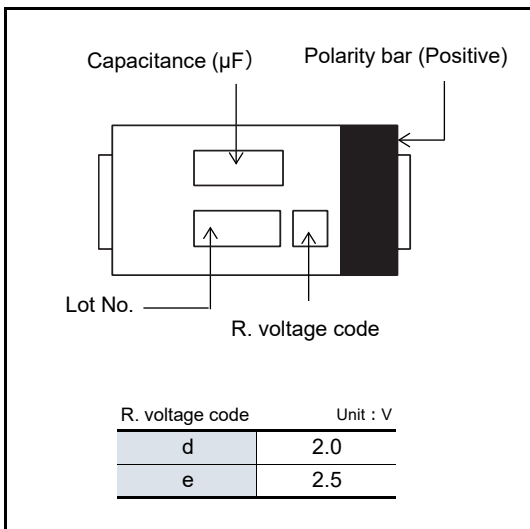

Explanation of part numbers

◇ Part number system e.g.: EEFLX0D331R

EEF		LX		0D		331		R	
Series	Product classification	Series	Code	Rated Voltage (V)	Code	Capacitance (μF)	Code	ESR (mΩ)	Special code
LX	EEF	LX	LX	2.0	0D	330	331	4.5	R4
				2.5	0E	470	471	6	R
						560	561		

Characteristics list

Series	Rated voltage (V)	Capacitance (μF)	Case size (mm)			Specification		Part number	Min. Packaging Q'ty ^{*3} (pcs)
			L	W	H	Ripple current ^{*1} (mA rms)	ESR ^{*2} (mΩ max.)		
LX	2.0	330	7.3	4.3	1.9	7500	6	EEFLX0D331R	3500
			7.3	4.3	1.9	8500	4.5	EEFLX0D331R4	3500
		470	7.3	4.3	1.9	7500	6	EEFLX0D471R	3500
			7.3	4.3	1.9	8500	4.5	EEFLX0D471R4	3500
		560	7.3	4.3	1.9	7500	6	EEFLX0D561R	3500
			7.3	4.3	1.9	8500	4.5	EEFLX0D561R4	3500
	2.5	330	7.3	4.3	1.9	7500	6	EEFLX0E331R	3500
			7.3	4.3	1.9	8500	4.5	EEFLX0E331R4	3500
		470	7.3	4.3	1.9	7500	6	EEFLX0E471R	3500
			7.3	4.3	1.9	8500	4.5	EEFLX0E471R4	3500

*1: Ripple current (100 kHz / +45 °C)

*2: ESR (100 kHz / +20 °C)

*3: Please contact us when 500 pcs packing is necessary.

◆ Please refer to each page in this catalog for "Reflow conditions" and "Taping specifications".

Temperature coefficient of ripple current

Temperature		T ≤ 45 °C	45 °C < T ≤ 85 °C	85 °C < T ≤ 105 °C
2.0 V to 2.5 V	Coefficient	1.0	0.7	0.25

◆ Ripple current should be controlled so that surface temperature of capacitor does not exceed the category temperature.

**Conductive Polymer Aluminum
Electrolytic Capacitors**
Surface Mount Type
SR/LR/SS/LS/ST/LT series

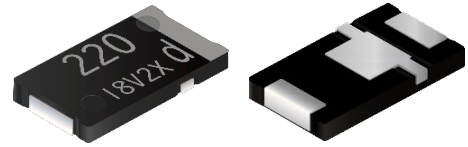

When SP-Cap is designed to be used under constant high load application such as represented in but not limited to the following products such as AI servers, switches, routers, and base stations, we strongly recommend using the long-life series (JX/KX/TX series) and avoid choosing standard series (SR/LR/SS/LS/ST/LT series).

Features

- Low profile (Height 1.0 mm max.)
- Low ESR (4.5 mΩ to 9 mΩ max.)
- Low ESL (3-terminals : 50% less than 2-terminals) [LR/LS/LT series]
- High ripple current (8500 mA rms max.)
- RoHS compliance, Halogen free

Specifications

Series	SR	LR	SS	LS	ST	LT
Category temp. range	-55 °C to +105 °C					
Rated voltage range	2.0 V to 6.3 V			2.0 V to 2.5 V		
Rated cap. range	68 μF to 220 μF			180 μF to 220 μF		270 μF to 330 μF
Capacitance tolerance	±20 % (120 Hz / +20 °C)					
DC leakage current	I ≤ 0.1 CV (μA) 2 minutes					
Dissipation factor (tan δ)	≤ 0.06 (120 Hz / + 20 °C)					
Surge voltage (V)	Rated voltage × 1.25 (15 °C to 35 °C)					
Endurance	+105 °C 2000 h, rated voltage applied					
	Capacitance change			Within ±20 % of the initial value		
	Dissipation factor (tan δ)			≤ 2 times of the initial limit		
	DC leakage current			≤ 3 times of the initial limit		
Damp heat (Steady state)	+60 °C, 90 % RH, 500 h, No-applied voltage					
	Capacitance change of initial measurd value		2.0 V to 2.5 V	4.0 V		6.3 V
			+70 %, -20 %	+60 %, -20 %		+50 %, -20 %
	Dissipation factor (tan δ)		≤ 2 times of the initial limit			
DC leakage current		Within the initial limit				

Marking

R. voltage code	Unit : V
d	2.0
e	2.5
g	4.0
j	6.3

Dimensions (not to scale)

2 terminals

3 terminals

SR/SS/ST series

Series	L±0.2	W1±0.2	W2±0.1	H±0.1	P±0.3
SR	7.3	4.3	2.4	1.0 ^{*1}	1.3
SS	7.3	4.3	2.4	1.1	1.3
ST	7.3	4.3	2.4	1.4	1.3

*1:max.

LR/LS/LT series

Series	L±0.2	W1±0.2	W2±0.1	H±0.1	P1±0.3	P2±0.1	P3±0.2	P4±0.2
LR	7.3	4.3	2.4	1.0 ^{*1}	1.3	1.1	0.7	1.4
LS	7.3	4.3	2.4	1.1	1.3	1.1	0.7	1.4
LT	7.3	4.3	2.4	1.4	1.3	1.1	0.7	1.4

*1:max.

* Externals of figure are the reference.

Design and specifications are each subject to change without notice. Ask factory for the current technical specifications before purchase and/or use.

Should a safety concern arise regarding this product, please be sure to contact us immediately.

If delivery specifications suitable for the intended use was not exchanged at the time of product purchase, we will not bear any responsibility.

Explanation of part numbers

◇ Part number system e.g.: EEFSR0D221R4

EEF		SR		0D		221		R4			
Series	Product classification	Series	Code	Rated Voltage (V)	Code	Capacitance (μF)	Code	Capacitance (μF)	Code	ESR (mΩ)	Special code
SR	EEF	SR	SR	2.0	0D	68	680	220	221	4.5	R4
SS		SS	SS	2.5	0E	120	121	270	271	6 (2.0, 2.5 V)	R
ST		ST	ST	4.0	0G	180	181	330	331	9 (4.0, 6.3 V)	
LR		LR	LR	6.3	0J						
LS		LS	LS								
LT		LT	LT								

Characteristics list

Series	Rated voltage (V)	Capacitance (μF)	Case size (mm)			Specification		The number of terminals		Part number	Min. Packaging Q'ty ^{*3} (pcs)
			L	W	H	Ripple current ^{*1} (mA rms)	ESR ^{*2} (mΩ max.)	2	3		
SR	2.0	220	7.3	4.3	1.0 max.	7500	6	○		EEFSR0D221R	3500
			7.3	4.3	1.0 max.	8500	4.5	○		EEFSR0D221R4	3500
	2.5	180	7.3	4.3	1.0 max.	7500	6	○		EEFSR0E181R	3500
			7.3	4.3	1.0 max.	8500	4.5	○		EEFSR0E181R4	3500
	4.0	120	7.3	4.3	1.0 max.	6300	9	○		EEFSR0G121R	3500
	6.3	68	7.3	4.3	1.0 max.	6300	9	○		EEFSR0J680R	3500
LR	2.0	220	7.3	4.3	1.0 max.	7500	6		○	EEFLR0D221R	3500
			7.3	4.3	1.0 max.	8500	4.5		○	EEFLR0D221R4	3500
	2.5	180	7.3	4.3	1.0 max.	7500	6		○	EEFLR0E181R	3500
			7.3	4.3	1.0 max.	8500	4.5		○	EEFLR0E181R4	3500
	4.0	120	7.3	4.3	1.0 max.	6300	9		○	EEFLR0G121R	3500
	6.3	68	7.3	4.3	1.0 max.	6300	9		○	EEFLR0J680R	3500
SS	2.0	220	7.3	4.3	1.1	7500	6	○		EEFSS0D221R	3500
	2.5	180	7.3	4.3	1.1	7500	6	○		EEFSS0E181R	3500
LS	2.0	220	7.3	4.3	1.1	7500	6		○	EEFLS0D221R	3500
	2.5	180	7.3	4.3	1.1	7500	6		○	EEFLS0E181R	3500
ST	2.0	330	7.3	4.3	1.4	7500	6	○		EEFST0D331R	3500
	2.5	270	7.3	4.3	1.4	7500	6	○		EEFST0E271R	3500
LT	2.0	330	7.3	4.3	1.4	7500	6		○	EEFLT0D331R	3500
	2.5	270	7.3	4.3	1.4	7500	6		○	EEFLT0E271R	3500

*1: Ripple current (100 kHz / +45 °C)

*2: ESR (100 kHz / +20 °C)

*3: Please contact us when 500 pcs packing is necessary.

◆ Please refer to each page in this catalog for "Reflow conditions" and "Taping specifications".

Temperature coefficient of ripple current

Temperature		T ≤ 45 °C	45 °C < T ≤ 85 °C	85 °C < T ≤ 105 °C
2.0 V to 6.3 V	Coefficient	1.0	0.7	0.25

◆ Ripple current should be controlled so that surface temperature of capacitor does not exceed the category temperature.

**Conductive Polymer Aluminum
Electrolytic Capacitors
Surface Mount Type**

GY series [Super low ESR]

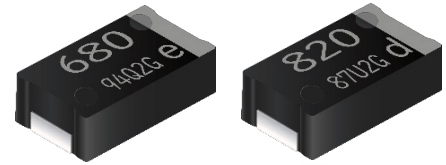

When SP-Cap is designed to be used under constant high load application such as represented in but not limited to the following products such as AI servers, switches, routers, and base stations, we strongly recommend using the long-life series (JX/KX/TX series) and avoid choosing standard series (GY series).

Features

- Super low ESR (3 mΩ max.)
- Large capacitance (820 μF max.)
- High ripple current (10200 mA rms max.)
- RoHS compliance, Halogen free

Specifications

Series	GY	
Category temp. range	-55 °C to +105 °C	
Rated voltage range	2.0 V to 2.5 V	
Rated cap. range	680 μF to 820 μF	
Capacitance tolerance	±20 % (120 Hz / +20 °C)	
DC leakage current	I ≤ 0.1 CV (μA) 2 minutes	
Dissipation factor (tan δ)	≤ 0.06 (120 Hz / + 20 °C)	
Surge voltage (V)	Rated voltage × 1.25 (15 °C to 35 °C)	
Endurance	+105 °C 2000 h, rated voltage applied	
	Capacitance change	Within ±20 % of the initial value
	Dissipation factor (tan δ)	≤ 2 times of the initial limit
	DC leakage current	≤ 3 times of the initial limit
Damp heat (Steady state)	+60 °C, 90 % RH, 500 h, No-applied voltage	
	Capacitance change of initial measured value	2.0 V to 2.5 V
		+70 %, -20 %
	Dissipation factor (tan δ)	≤ 2 times of the initial limit
DC leakage current	Within the initial limit	

Marking

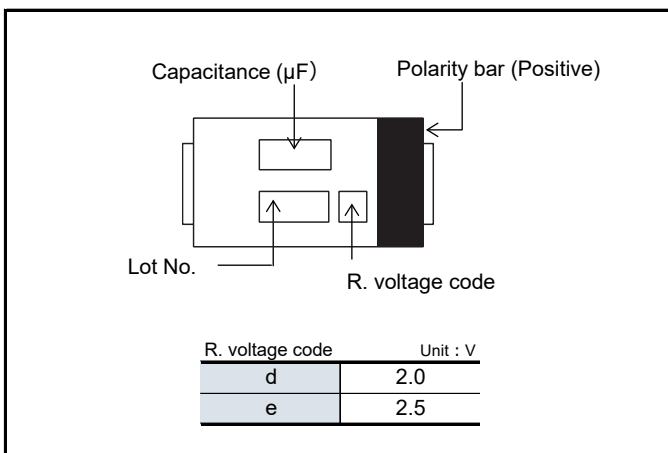

Dimensions (not to scale)

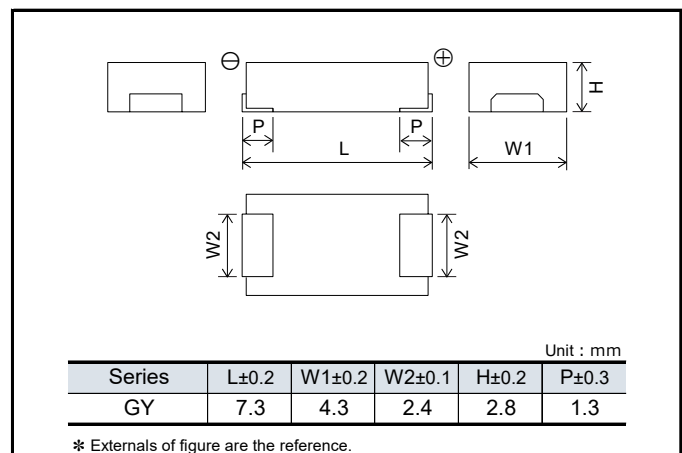

Explanation of part numbers

◇ Part number system e.g.: EEFGY0D821R

EEF		GY		0D		821		R	
Series	Product classification	Series	Code	Rated Voltage (V)	Code	Capacitance (μF)	Code	ESR (mΩ)	Special code
GY	EEF	GY	GY	2.0	0D	680	681	3	R
				2.5	0E	820	821		

Characteristics list

Series	Rated voltage (V)	Capacitance (μF)	Case size (mm)			Specification		Part number	Min. Packaging Q'ty (pcs)
			L	W	H	Ripple current ^{*1} (mA rms)	ESR ^{*2} (mΩ max.)		
GY	2.0	820	7.3	4.3	2.8	10200	3	EEFGY0D821R	2000
	2.5	680	7.3	4.3	2.8	10200	3	EEFGY0E681R	2000

*1: Ripple current (100 kHz / +45 °C)

*2: ESR (100 kHz / +20 °C)

◆ Please refer to each page in this catalog for "Reflow conditions" and "Taping specifications".

Temperature coefficient of ripple current

Temperature		T ≤ 45 °C	45 °C < T ≤ 85 °C	85 °C < T ≤ 105 °C
2.0 V to 2.5 V	Coefficient	1.0	0.7	0.25

◆ Ripple current should be controlled so that surface temperature of capacitor does not exceed the category temperature.

**Conductive Polymer Aluminum
Electrolytic Capacitors
Surface Mount Type**

CY/SY series [Guaranteed at 85 °C]

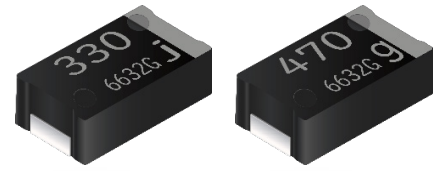

When SP-Cap is designed to be used under constant high load application such as represented in but not limited to the following products such as AI servers, switches, routers, and base stations, we strongly recommend using the long-life series (JX/KX/TX series) and avoid choosing standard series (CY/SY series).

Features

- Endurance 85 °C 2000 h
- Product height (3.0 mm max.)
- High ripple current (5100 mA rms to 6300 mA rms max.)
- RoHS compliance, Halogen free

Specifications

Series	CY / SY		
Category temp. range	-55 °C to +85 °C		
Rated voltage range	4.0 V, 6.3V		
Rated cap. range	330 μF to 470 μF		
Capacitance tolerance	±20 % (120 Hz / +20 °C)		
DC leakage current	I ≤ 0.1 CV (μA) 2 minutes		
Dissipation factor (tan δ)	≤ 0.06 (120 Hz / + 20 °C)		
Surge voltage (V)	Rated voltage × 1.25 (15 °C to 35 °C)		
Endurance	+85 °C 2000 h, rated voltage applied		
	Capacitance change	Within ±20 % of the initial value	
	Dissipation factor (tan δ)	≤ 2 times of the initial limit	
	DC leakage current	≤ 3 times of the initial limit	
Damp heat (Steady state)	+60 °C, 90 % RH, 500 h, No-applied voltage		
	Capacitance change of initial measured value	4.0 V	6.3 V
		+60 %, -20 %	+50 %, -20 %
	Dissipation factor (tan δ)	≤ 2 times of the initial limit	
DC leakage current	Within the initial limit		

Marking

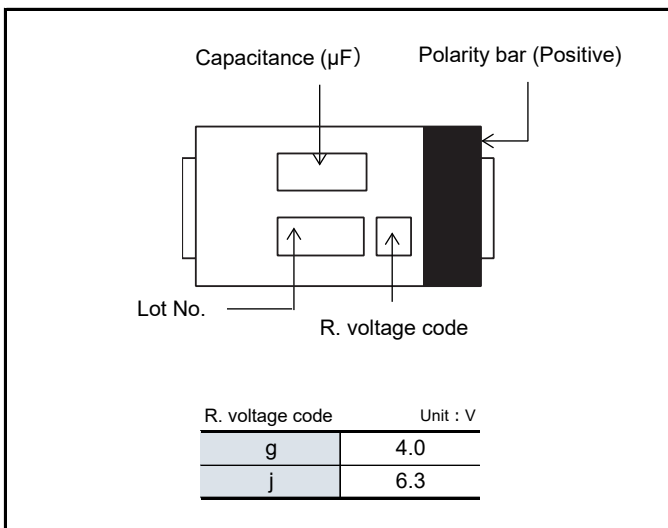

Dimensions (not to scale)

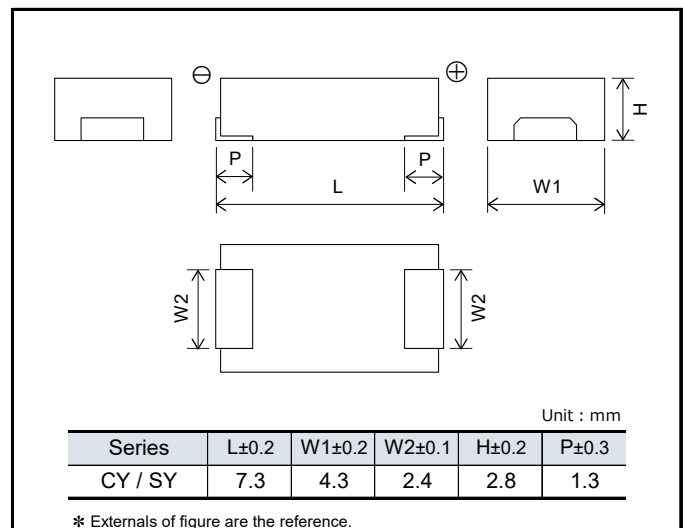

Explanation of part numbers

◇ Part number system e.g.: ECGCY0G471R

ECG		CY		0G		471		R	
Series	Product classification	Series	Code	Rated Voltage (V)	Code	Capacitance (μF)	Code	ESR (mΩ)	Special code
CY	ECG	CY	CY	4.0	0G	330	331	9, 15	R
SY		SY	SY	6.3	0J	470	471		

Characteristics list

Series	Rated voltage (V)	Capacitance (μF)	Case size (mm)			Specification		Part number	Min. Packaging Q'ty ^{*3} (pcs)
			L	W	H	Ripple current ^{*1} (mA rms)	ESR ^{*2} (mΩ max.)		
CY	4.0	470	7.3	4.3	2.8	5100	15	ECGCY0G471R	2000
	6.3	330	7.3	4.3	2.8	5100	15	ECGCY0J331R	2000
SY	4.0	470	7.3	4.3	2.8	6300	9	ECGSY0G471R	2000
	6.3	330	7.3	4.3	2.8	6300	9	ECGSY0J331R	2000

*1: Ripple current (100 kHz / +45 °C)

*2: ESR (100 kHz / +20 °C)

*3: Please contact us when 500 pcs packing is necessary.

◆ Please refer to each page in this catalog for "Reflow conditions" and "Taping specifications".

Temperature coefficient of ripple current

Temperature		$T \leq 45 \text{ }^\circ\text{C}$	$45 \text{ }^\circ\text{C} < T \leq 65 \text{ }^\circ\text{C}$	$65 \text{ }^\circ\text{C} < T \leq 85 \text{ }^\circ\text{C}$
4.0 V to 6.3 V	Coefficient	1.0	0.7	0.25

◆ Ripple current should be controlled so that surface temperature of capacitor does not exceed the category temperature.

Conductive Polymer Aluminum Electrolytic Capacitors
Surface Mount Type

HX series [Guaranteed at 125 °C]

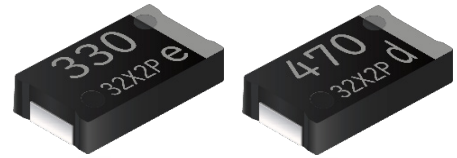

When SP-Cap is designed to be used under constant high load application such as represented in but not limited to the following products such as AI servers, switches, routers, and base stations, we strongly recommend using the long-life series (JX/KX/TX series) and avoid choosing standard series (HX series).

Features

- Endurance 125 °C 1000 h
- High voltage & Large capacitance (2.0 V / 560 μF to 25 V / 33 μF)
- Low ESR (4.5 mΩ max.)
- RoHS compliance, Halogen free

Specifications

Series	HX		
Category temp. range	-55 °C to +125 °C		
Rated voltage range	2.0 V to 2.5 V, 10 V to 25 V		
Category voltage range	1.6 V to 2.0 V, 8.0 V to 20 V		
Rated cap. range	15 μF to 470 μF		
Capacitance tolerance	±20 % (120 Hz / +20 °C)		
DC leakage current	I ≤ 0.1 CV(μA) [2.0 V to 2.5 V, 2 min], I ≤ 0.3 CV(μA) [10 V to 25 V, 2 min]		
Dissipation factor (tan δ)	≤ 0.1 (120 Hz / +20 °C)		
Surge voltage (V)	Rated voltage × 1.25 [2.0 V to 16 V], × 1.15 [20 V to 25 V] (15 °C to 35 °C)		
Endurance	+125 °C 1000 h, category voltage applied		
	Capacitance change	Within ±20 % of the initial value	
	Dissipation factor (tan δ)	≤ 2 times of the initial limit	
	DC leakage current	Within the initial limit	
Damp heat (Steady state)	After storing for 500 hours at +60 °C, 90 % RH		
	Capacitance change of initial measured value	2.0 V to 2.5 V	10 V to 25 V
		+70 %, -20 %	+60 %, -20 %
	Dissipation factor (tan δ)	≤ 2 times of the initial limit	
DC leakage current	Within the initial limit : 2.0 V to 2.5 V ≤ 3 times of the initial limit : 10 V to 25 V		

Marking

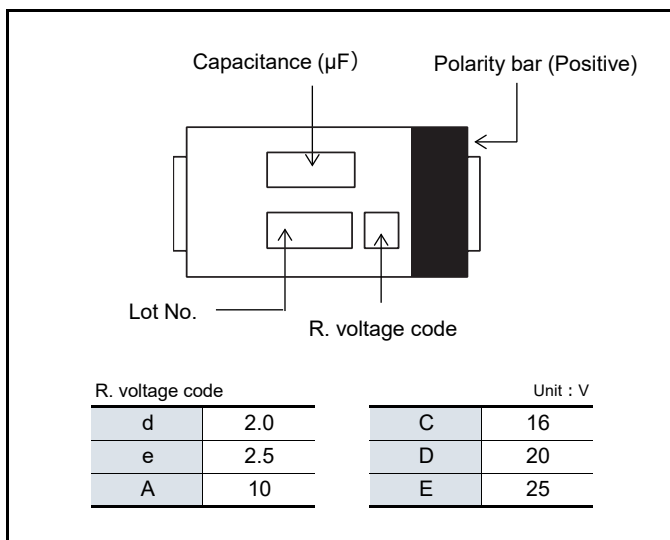

Dimensions (not to scale)

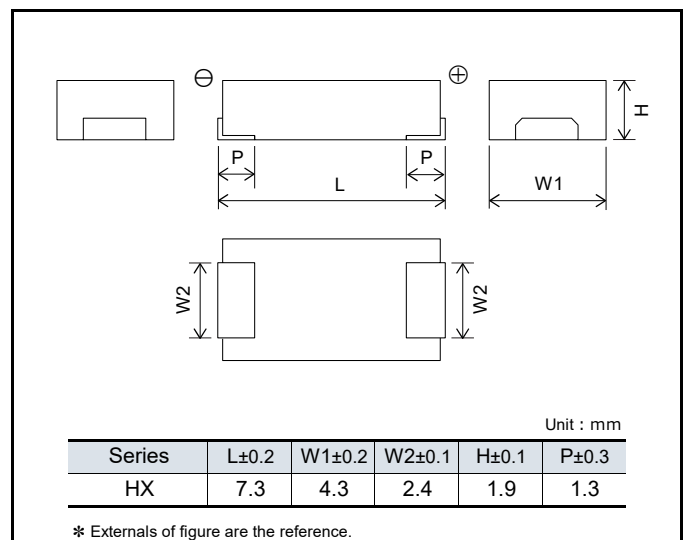

Explanation of part numbers

◇ **Part number system**

e.g.: EEFHX0D471R9

EEF		HX		0D		471		R9			
Series	Product classification	Series	Code	Rated Voltage (V)	Code	Capacitance (μF)	Code	Capacitance (μF)	Code	ESR (mΩ)	Special Code
HX	EEF	HX	HX	2.0	0D	15	150	68	680	15 (2.0, 2.5 V)	R
				2.5	0E	22	220	100	101	40 (10 to 25 V)	
				10	1A	33	330	330	331	4.5	R4
				16	1C	47	470	470	471	6	R6
				20	1D	56	560			9	R9
				25	1E						

Characteristics list

■ **2.0 V to 2.5 V**

Series	Rated voltage [105 °C] (V)	Category voltage [125 °C] (V)	Capacitance (μF)	Case size (mm)			Specification		Part number	Min. Packaging Q'ty ^{*3} (pcs)
				L	W	H	Ripple current ^{*1} (mA rms)	ESR ^{*2} (mΩ max.)		
HX	2.0	1.6	470	7.3	4.3	1.9	5100	15	EEFHX0D471R	3500
				7.3	4.3	1.9	6300	9	EEFHX0D471R9	3500
				7.3	4.3	1.9	7500	6	EEFHX0D471R6	3500
				7.3	4.3	1.9	8500	4.5	EEFHX0D471R4	3500
	2.5	2.0	330	7.3	4.3	1.9	5100	15	EEFHX0E331R	3500
				7.3	4.3	1.9	6300	9	EEFHX0E331R9	3500
				7.3	4.3	1.9	7500	6	EEFHX0E331R6	3500
				7.3	4.3	1.9	8500	4.5	EEFHX0E331R4	3500

■ **10 V to 25 V**

Not Recommended for New Design

For replacement

Series	Rated voltage [105 °C] (V)	Category voltage [125 °C] (V)	Capacitance (μF)	Case size (mm)			Specification		Part number	Min. Packaging Q'ty ^{*3} (pcs)
				L	W	H	Ripple current ^{*1} (mA rms)	ESR ^{*2} (mΩ max.)		
HX	10	8.0	47	7.3	4.3	1.9	3200	40	EEFHX1A470R	3500
			68	7.3	4.3	1.9	3200	40	EEFHX1A680R	3500
			100	7.3	4.3	1.9	3200	40	EEFHX1A101R	3500
	16	12.8	15	7.3	4.3	1.9	3200	40	EEFHX1C150R	3500
			22	7.3	4.3	1.9	3200	40	EEFHX1C220R	3500
			33	7.3	4.3	1.9	3200	40	EEFHX1C330R	3500
			47	7.3	4.3	1.9	3200	40	EEFHX1C470R	3500
	20	16	68	7.3	4.3	1.9	3200	40	EEFHX1C680R	3500
			22	7.3	4.3	1.9	3200	40	EEFHX1D220R	3500
			33	7.3	4.3	1.9	3200	40	EEFHX1D330R	3500
			47	7.3	4.3	1.9	3200	40	EEFHX1D470R	3500
	25	20	56	7.3	4.3	1.9	3200	40	EEFHX1D560R	3500
			15	7.3	4.3	1.9	3200	40	EEFHX1E150R	3500
			22	7.3	4.3	1.9	3200	40	EEFHX1E220R	3500
			33	7.3	4.3	1.9	3200	40	EEFHX1E330R	3500

*1: Ripple current (100 kHz / +45 °C)

*2: ESR (100 kHz / +20 °C)

*3: Please contact us when 500 pcs packing is necessary.

◆ Please refer to each page in this catalog for "Reflow conditions" and "Taping specifications".

Temperature coefficient of ripple current

Temperature		T ≤ 45 °C	45 °C < T ≤ 85 °C	85 °C < T ≤ 105 °C	105 °C < T ≤ 125 °C
2.0 V to 2.5 V	Coefficient	1.0	0.7	0.25	0.25
10 V to 25 V		1.0	0.8	0.5	0.25

◆ Ripple current should be controlled so that surface temperature of capacitor does not exceed the category temperature.

Design and specifications are each subject to change without notice. Ask factory for the current technical specifications before purchase and/or use.

Should a safety concern arise regarding this product, please be sure to contact us immediately.

If delivery specifications suitable for the intended use was not exchanged at the time of product purchase, we will not bear any responsibility.

Replacement list for “Not recommended for new design”

* If you are using any of the following models on the deleted list, please substitute them with the suggested alternative model as soon as possible.

Non-recommended part number						Replacement part number							
Series	Cate-gory temp. range max. (°C)	Rated voltage (V)	Capaci-tance (µF)	ESR (mΩ)	Part number	Series	Size code	Cate-gory temp. range max. (°C)	Rated voltage (V)	Capaci-tance (µF)	ESR (mΩ)	Part number	
CS	105	10	47	40	EEFCS1A470R	POSCAP TQC	D15	105	16	47	55	16TQC47MYFT	
						POSCAP TPE	B2	85	10	47	35	10TPE47MAZB	
						OS-CON SVP	C6	105	10	47	50	10SVP47M	
						Hybrid ZA	D	105	25	47	50	EEHZA1E470P	
	105	16	15	40	EEFCS1C150R	POSCAP TQC	D15	105	16	47	55	16TQC47MYFT	
						OS-CON SVP	B6	105	16	22	90	16SVP22M	
						Hybrid ZA	C	105	25	22	80	EEHZA1E220R	
	105	16	22	40	EEFCS1C220R	POSCAP TQC	D15	105	16	47	55	16TQC47MYFT	
						OS-CON SVP	B6	105	16	22	90	16SVP22M	
						Hybrid ZA	C	105	25	22	80	EEHZA1E220R	
	105	16	33	40	EEFCS1C330R	POSCAP TQC	D15	105	16	47	55	16TQC47MYFT	
						OS-CON SVPC	B6	105	16	39	27	16SVPC39MV	
						Hybrid ZA	C	105	25	33	80	EEHZA1E330R	
	105	20	10	40	EEFCS1D100R	POSCAP TQC	D15	105	20	47	55	20TQC47MYFT	
						OS-CON SVPA	B6	105	20	10	40	20SVPA10M	
						Hybrid ZA	C	105	35	10	100	EEHZA1V100R	
	105	20	15	40	EEFCS1D150R	POSCAP TQC	D15	105	20	47	55	20TQC47MYFT	
						OS-CON SVPA	C6	105	20	22	35	20SVPA22M	
						Hybrid ZA	C	105	25	22	80	EEHZA1E220R	
	105	20	22	40	EEFCS1D220R	POSCAP TQC	D15	105	20	47	55	20TQC47MYFT	
						OS-CON SVPA	C6	105	20	22	35	20SVPA22M	
						Hybrid ZA	C	105	25	22	80	EEHZA1E220R	
	105	25	10	40	EEFCS1E100R	POSCAP TQC	D2	105	25	22	60	25TQC22MYFD	
						POSCAP TQS	D15	105	35	47	100	35TQS47MEX	
POSCAP TQC						D2	105	25	15	90	25TQC15MYFD		
OS-CON SVPD						C6	125	25	10	65	25SVPD10M		
105	25	15	40	EEFCS1E150R	Hybrid ZA	C	105	35	10	100	EEHZA1V100R		
					POSCAP TQC	D2	105	25	22	60	25TQC22MYFD		
					POSCAP TQS	D15	105	35	47	100	35TQS47MEX		
					POSCAP TQC	D2	105	25	15	90	25TQC15MYFD		
105	35	10	40	EEFCS1V100R	OS-CON SVPK	B6	125	25	33	35	25SVPK33M		
					Hybrid ZA	C	105	25	22	80	EEHZA1E220R		
					POSCAP TQC	D2	105	35	10	120	35TQC10MYF		
CT	105	10	68	40	EEFCT1A680R	OS-CON SVPK	B6	125	35	22	35	35SVPK22M	
						Hybrid ZA	C	105	35	10	100	EEHZA1V100R	
						POSCAP TQC	D15	105	16	47	55	16TQC47MYFT	
						POSCAP TPC	D2	105	10	100	45	10TPC100M	
						OS-CON SVPC	B6	105	10	68	30	10SVPC68M	
	105	16	47	40	EEFCT1C470R	Hybrid ZA	D8	105	25	68	30	EEHZA1E680XP	
						Hybrid ZA	D8	105	35	68	35	EEHZA1V680XP	
						POSCAP TQC	D15	105	16	47	55	16TQC47MYFT	
	105	20	33	40	EEFCT1D330R	OS-CON SVF	B6	125	16	82	27	16SVF82M	
						Hybrid ZA	D	105	25	47	50	EEHZA1E470P	
						POSCAP TQC	D15	105	20	47	55	20TQC47MYFT	
	105	20	47	40	EEFCT1D470R	OS-CON SVPK	B6	125	25	33	35	25SVPK33M	
						Hybrid ZA	C	105	25	33	80	EEHZA1E330R	
						POSCAP TQC	D15	105	20	47	55	20TQC47MYFT	
	105	25	22	40	EEFCT1E220R	OS-CON SVPF	C6	105	25	47	30	25SVPF47M	
						Hybrid ZA	D	105	25	47	50	EEHZA1E470P	
						POSCAP TQC	D15	105	25	22	70	25TQC22MYFT	
						POSCAP TQS	D15	105	35	47	100	35TQS47MEX	
	105	35	15	40	EEFCT1V150R	OS-CON SVPF	B6	105	25	27	40	25SVPF27MX	
						Hybrid ZA	C	105	25	22	80	EEHZA1E220R	
						POSCAP TQC	D2	105	35	15	150	35TQC15MYF	
													35SVPK22M
													EEHZA1V220R

Replacement list for “Not recommended for new design”

* If you are using any of the following models on the deleted list, please substitute them with the suggested alternative model as soon as possible.

Non-recommended part number						Replacement part number						
Series	Cate-gory temp. range max. (°C)	Rated voltage (V)	Capaci-tance (μF)	ESR (mΩ)	Part number	Series	Size code	Cate-gory temp. range max. (°C)	Rated voltage (V)	Capaci-tance (μF)	ESR (mΩ)	Part number
CX	105	10	100	40	EEFCX1A101R	POSCAP TPC	D2	105	10	100	45	10TPC100M
						OS-CON SVPC	C6	105	10	120	22	10SVPC120MV
						Hybrid ZA	D8	105	25	100	30	EEHZA1E101XP
	105	10	47	40	EEFCX1A470R	POSCAP TPE	D2E	105	10	68	25	10TPE68M
						POSCAP TPE	B2	85	10	47	35	10TPE47MAZB
						OS-CON SVP	C6	105	10	47	50	10SVP47M
						Hybrid ZA	D	105	25	47	50	EEHZA1E470P
	105	10	68	40	EEFCX1A680R	POSCAP TPC	D2	105	10	100	45	10TPC100M
						POSCAP TQC	D2	105	16	68	50	16TQC68MYF
						OS-CON SVPC	B6	105	10	68	23	10SVPC68MV
						Hybrid ZA	D8	105	25	68	30	EEHZA1E680XP
						Hybrid ZA	D8	105	35	68	35	EEHZA1V680XP
	105	16	15	40	EEFCX1C150R	POSCAP TQC	D2	105	16	47	40	16TQC47MW
						POSCAP TQC	B2	105	16	15	90	16TQC15M
						OS-CON SVP	B6	105	16	22	90	16SVP22M
						Hybrid ZA	C	105	25	22	80	EEHZA1E220R
	105	16	22	40	EEFCX1C220R	POSCAP TQC	B2	105	16	22	90	16TQC22MYFB
						OS-CON SVP	B6	105	16	22	90	16SVP22M
						Hybrid ZA	C	105	25	22	80	EEHZA1E220R
	105	16	33	40	EEFCX1C330R	POSCAP TQC	B2	105	16	33	90	16TQC33MYFB
						OS-CON SVPC	B6	105	16	39	27	16SVPC39MV
						Hybrid ZA	C	105	25	33	80	EEHZA1E330R
	105	16	47	40	EEFCX1C470R	OS-CON SVPF	B6	105	16	82	27	16SVPF82M
						Hybrid ZA	D	105	25	47	50	EEHZA1E470P
	105	16	68	40	EEFCX1C680R	POSCAP TQC	D2	105	16	68	50	16TQC68MYF
						POSCAP TQC	D2	105	16	100	50	16TQC100MYF
						OS-CON SVPC	C6	105	16	68	25	16SVPC68MV
						Hybrid ZA	D8	105	25	68	30	EEHZA1E680XP
						Hybrid ZA	D8	105	35	68	35	EEHZA1V680XP
	105	20	22	40	EEFCX1D220R	POSCAP TQC	D2	105	20	33	60	20TQC33MYFD
						POSCAP TQC	B2	105	20	22	90	20TQC22MYFB
						OS-CON SVPA	C6	105	20	22	35	20SVPA22M
						Hybrid ZA	C	105	25	22	80	EEHZA1E220R
	105	20	33	40	EEFCX1D330R	POSCAP TQC	D2	105	20	33	60	20TQC33MYFD
						POSCAP TQC	D2	105	20	47	55	20TQC47MYF
						OS-CON SVPK	B6	125	25	33	35	25SVPK33M
						Hybrid ZA	C	105	25	33	80	EEHZA1E330R
	105	20	47	40	EEFCX1D470R	POSCAP TQC	D15	105	20	47	55	20TQC47MYFT
						OS-CON SVPF	C6	105	25	47	30	25SVPF47M
						Hybrid ZA	D	105	25	47	50	EEHZA1E470P
	105	20	56	40	EEFCX1D560R	POSCAP TQC	D2	105	20	100	100	20TQC100MD2
						OS-CON SVPF	B6	105	20	56	30	20SVPF56MX
	105	25	15	40	EEFCX1E150R	Hybrid ZA	C	105	25	56	50	EEHZA1E560P
						POSCAP TQC	B2	105	25	15	100	25TQC15MYFB
						OS-CON SVPK	B6	125	25	33	35	25SVPK33M
	105	25	22	40	EEFCX1E220R	Hybrid ZA	C	105	25	22	80	EEHZA1E220R
						POSCAP TQC	D2	105	25	22	60	25TQC22MYFD
OS-CON SVPF						B6	105	25	27	40	25SVPF27M	
105	25	33	40	EEFCX1E330R	Hybrid ZA	C	105	25	22	80	EEHZA1E220R	
					POSCAP TQC	D2	105	25	22	60	25TQC22MYFD	
					OS-CON SVPK	B6	125	25	33	35	25SVPK33M	
105	35	15	40	EEFCX1V150R	Hybrid ZA	C	105	25	33	80	EEHZA1E330R	
					POSCAP TQC	D2	105	35	15	150	35TQC15MYF	
					OS-CON SVPK	B6	125	35	22	35	35SVPK22M	
105	35	22	40	EEFCX1V220R	Hybrid ZA	C	105	35	22	100	EEHZA1V220R	
					POSCAP TQC	D2	105	35	15	150	35TQC15MYF	
					OS-CON SVPK	B6	125	35	22	35	35SVPK22M	
					Hybrid ZA	C	105	35	22	100	EEHZA1V220R	

Replacement list for “Not recommended for new design”

* If you are using any of the following models on the deleted list, please substitute them with the suggested alternative model as soon as possible.

Non-recommended part number					Replacement part number							
Series	Cate-gory temp. range max. (°C)	Rated voltage (V)	Capaci-tance (μF)	ESR (mΩ)	Part number	Series	Size code	Cate-gory temp. range max. (°C)	Rated voltage (V)	Capaci-tance (μF)	ESR (mΩ)	Part number
HX	125	10	47	40	EEFHX1A470R	POSCAP TDC	D2	125	16	100	50	16TDC100MYF
						OS-CON SVPD	C6	125	10	56	45	10SVPD56M
						Hybrid ZC	D	125	25	47	50	EEHZC1E470P
	125	10	68	40	EEFHX1A680R	POSCAP TDC	D2	125	16	100	50	16TDC100MYF
						OS-CON SVPK	B6	125	20	68	30	20SVPK68M
						Hybrid ZC	D8	125	25	68	30	EEHZC1E680XP
	125	10	100	40	EEFHX1A101R	POSCAP TDC	D2	125	16	100	50	16TDC100MYF
						POSCAP TCF	D3L	105	10	150	15	10TCF150ML
						OS-CON SVPK	B6	125	16	100	27	16SVPK100M
	125	16	15	40	EEFHX1C150R	Hybrid ZC	D8	125	25	100	30	EEHZC1E101XP
						POSCAP TDC	D2	125	16	100	50	16TDC100MYF
						POSCAP TDC	B2	125	16	33	90	16TDC33MYFB
	125	16	22	40	EEFHX1C220R	Hybrid ZC	C	125	25	22	80	EEHZC1E220R
						POSCAP TDC	D2	125	16	100	50	16TDC100MYF
						POSCAP TDC	B2	125	16	33	90	16TDC33MYFB
	125	16	33	40	EEFHX1C330R	OS-CON SVPK	B6	125	35	22	35	35SVPK22M
						Hybrid ZC	C	125	25	22	80	EEHZC1E220R
						POSCAP TDC	D2	125	16	100	50	16TDC100MYF
	125	16	47	40	EEFHX1C470R	POSCAP TDC	B2	125	16	33	90	16TDC33MYFB
						OS-CON SVPK	B6	125	25	33	35	25SVPK33M
						Hybrid ZC	C	125	25	33	80	EEHZC1E330R
	125	16	68	40	EEFHX1C680R	POSCAP TDC	D2	125	16	100	50	16TDC100MYF
						OS-CON SVF	B6	125	16	82	27	16SVF82M
						Hybrid ZC	D8	125	25	68	30	EEHZC1E680XP
	125	20	22	40	EEFHX1D220R	OS-CON SVPK	B6	125	35	22	35	35SVPK22M
						Hybrid ZC	C	125	25	22	80	EEHZC1E220R
						POSCAP TDC	B2	125	20	22	90	20TDC22MYFB
	125	20	33	40	EEFHX1D330R	OS-CON SVPK	B6	125	25	33	35	25SVPK33M
						Hybrid ZC	C	125	25	33	80	EEHZC1E330R
	125	20	47	40	EEFHX1D470R	OS-CON SVPK	C6	125	35	47	27	35SVPK47M
						Hybrid ZC	D	125	25	47	50	EEHZC1E470P
	125	20	56	40	EEFHX1D560R	OS-CON SVF	B6	125	20	56	30	20SVF56M
						Hybrid ZC	D	125	25	56	50	EEHZC1E560P
	125	25	15	40	EEFHX1E150R	POSCAP TDC	D3L	125	25	68	70	25TDC68MYF
						POSCAP TDC	B2	125	25	15	100	25TDC15MYFB
						OS-CON SPF	B6	125	25	27	40	25SVF27M
						Hybrid ZC	C	125	25	22	80	EEHZC1E220R
	125	25	22	40	EEFHX1E220R	POSCAP TDC	D3L	125	25	68	70	25TDC68MYF
						OS-CON SVF	B6	125	25	27	40	25SVF27M
						Hybrid ZC	C	125	25	22	80	EEHZC1E220R
	125	25	33	40	EEFHX1E330R	POSCAP TDC	D3L	125	25	68	70	25TDC68MYF
						OS-CON SVPK	B6	125	25	33	35	25SVPK33M
						Hybrid ZC	C	125	25	33	80	EEHZC1E330R

Safety Precautions

When using our products, no matter what sort of equipment they might be used for, be sure to confirm the applications and environmental conditions with our specifications in advance.

Panasonic
INDUSTRY

Panasonic Industry Co., Ltd.
Device Solutions Business Division

1006 Kadoma, Kadoma City, Osaka
571-8506 Japan