

Mechanical Relays

Power Relays (Over 2 A) /

High-capacity DC cut off Relays /

Signal Relays (2 A or less) /

Microwave Devices / Safety Relays

SELECTION GUIDE

IN Better Solution

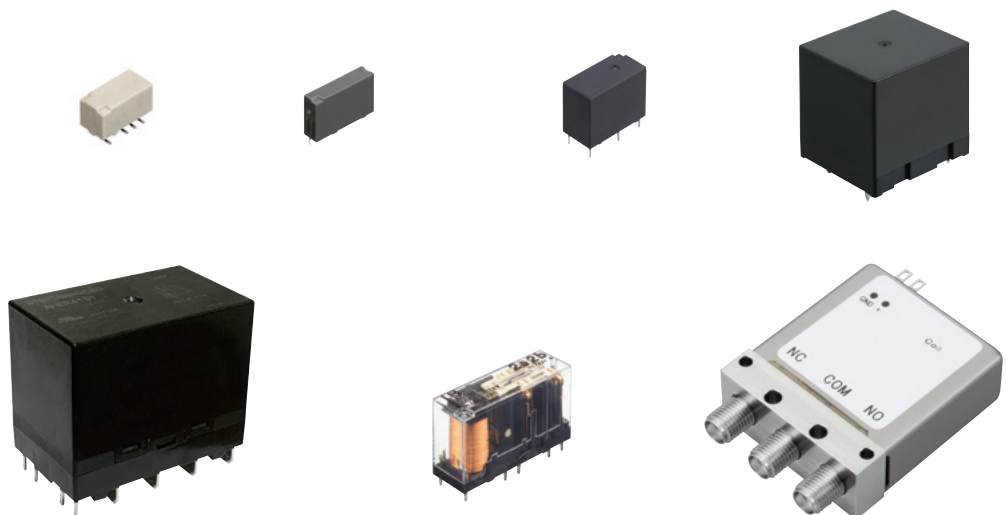

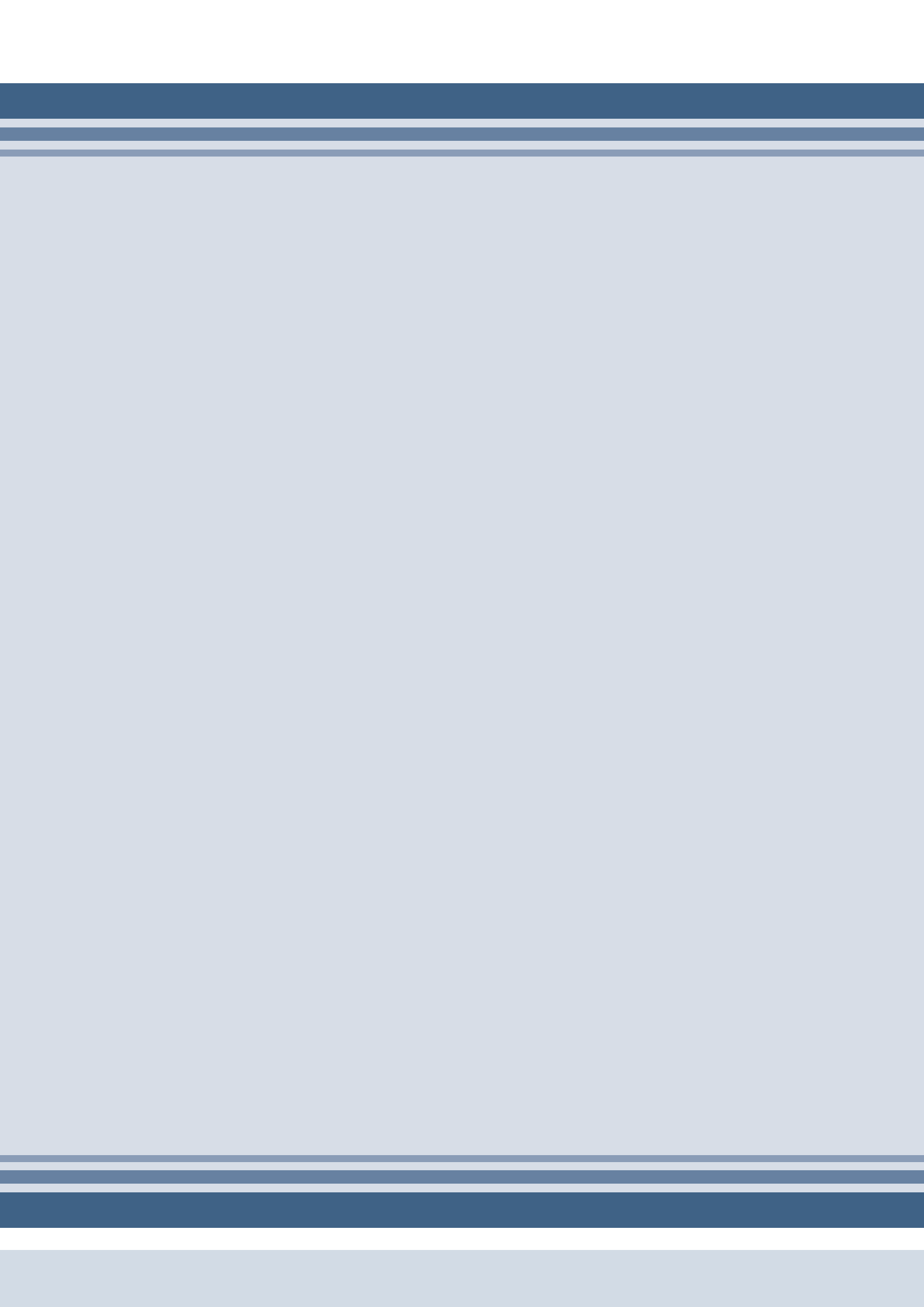

INDEX

◆ Power relays (Over 2A) line up	2
◆ DC load switching capacity (reference value)	3
◆ Signal relays (2A or less) line up	4
◆ Microwave devices line up	6
◆ Safety relays line up	8
◆ Power relays (Over 2A) selector chart	10
◆ High-capacityDC cut off relays selector chart	20
◆ Signal relays (2A or less) selector chart	21
◆ Microwave devices selector chart	25
◆ Safety relays selector chart	27
◆ Characteristics	29

Power relays line up

Non polarized type power relays

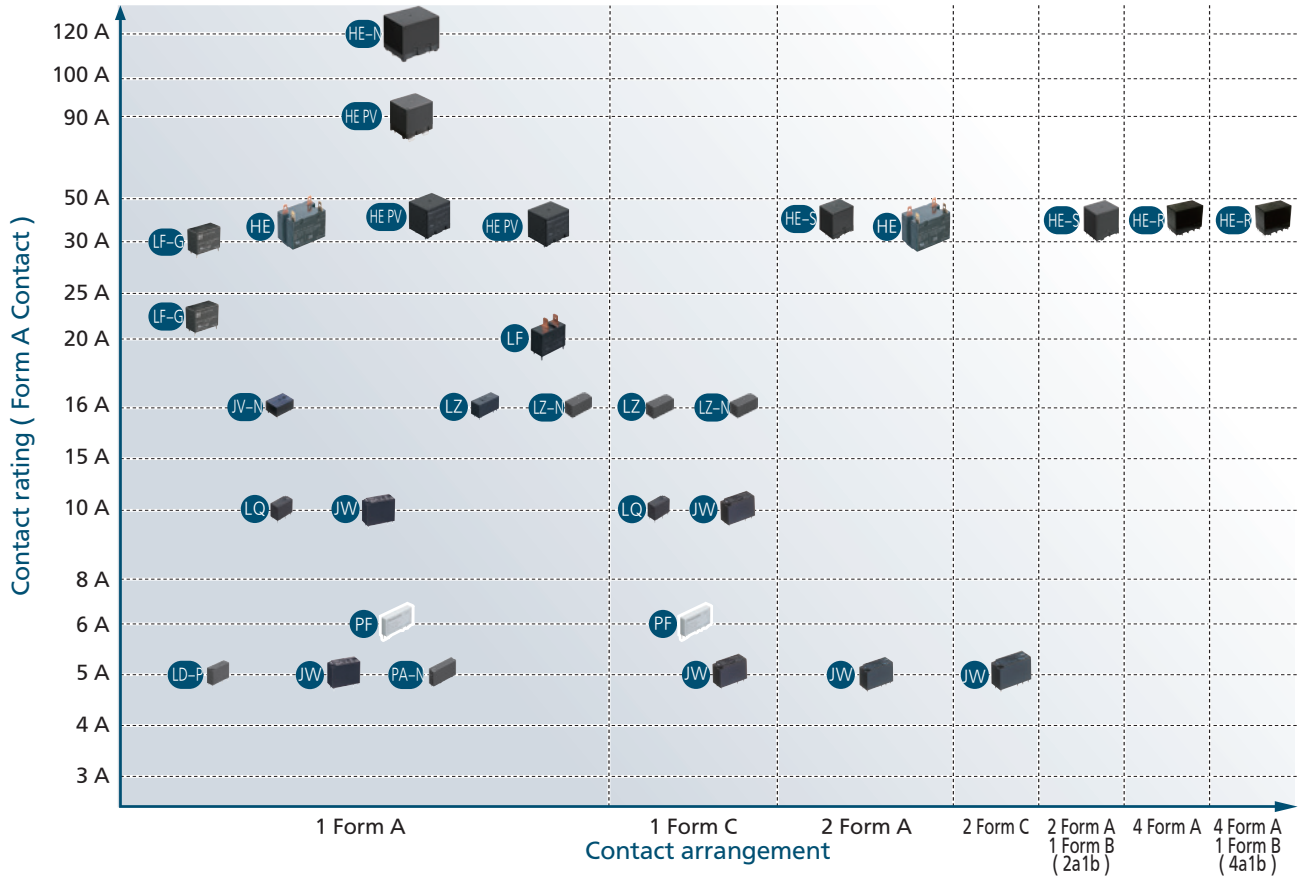



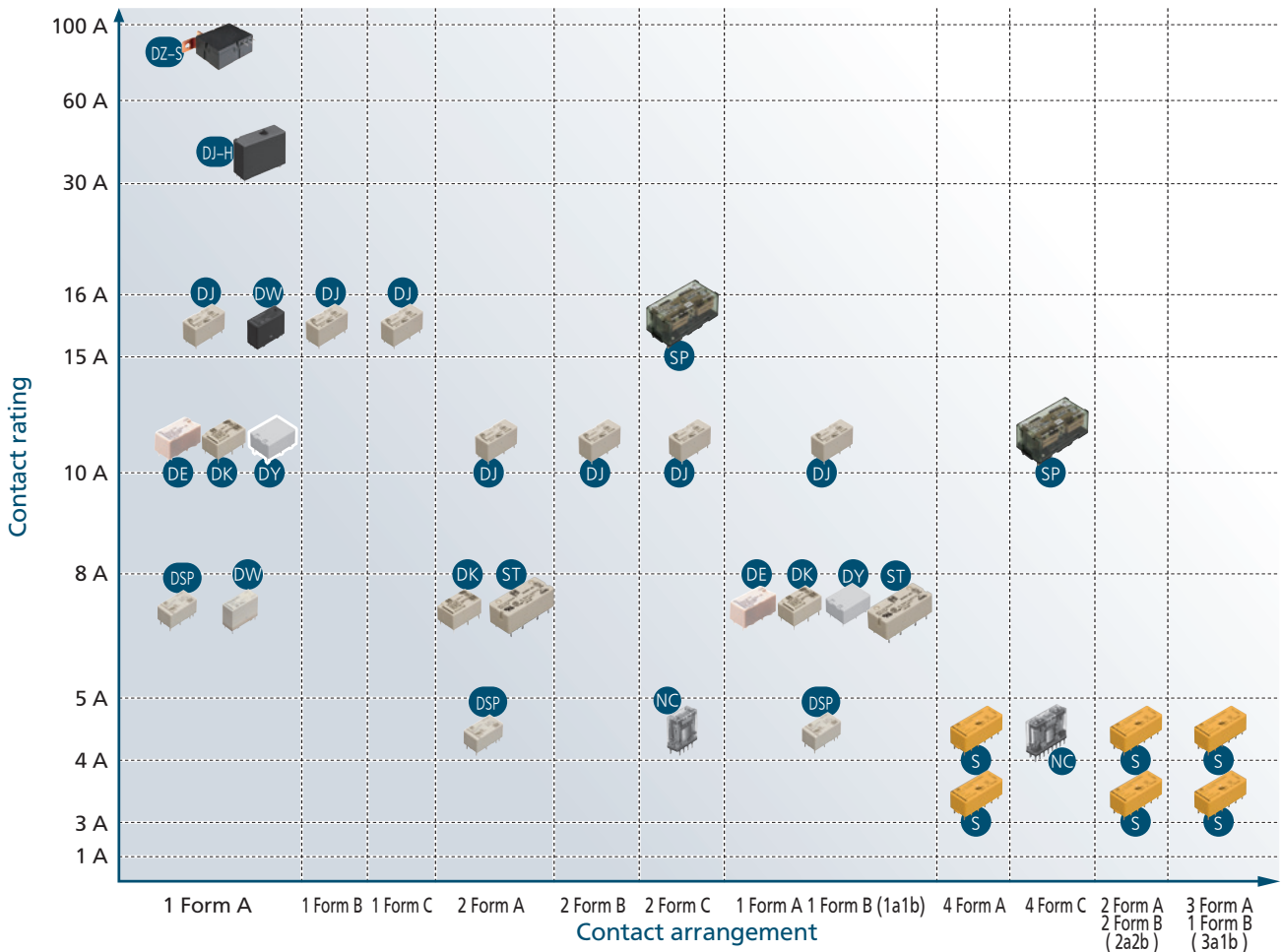

Polarized type power relays (with latching)



DC load switching capacity (reference value)

AC load relays shown below can switch DC load as following chart

Appearance	Product name	Contact	Load voltage	Current	Electrical expected life(resistive load)	Remarks
	LF-G (33A)	1 Form A	30 V DC	33 A	10 ⁴	—
	HE PV (48A)	1 Form A	75 V DC	35 A		—
			110 V DC	10 A		—
	HE PV (90A)	1 Form A	60 V DC	80 A		—
	HE-N (120A)	1 Form A	60 V DC	120 A		—
	HE-S (35A)	2 Form A	75 V DC	35 A	1 Form A contact only	
			110 V DC	10 A	1 Form A contact only	
			220 V DC	10 A	Each 1 Form A contact connected in series	

This chart is guideline for using DC load. Please test actual condition before use.

Maximum DC load switching capacity

Conditions: resistive load, electrical expected life of 10⁴ cycles (reference value)

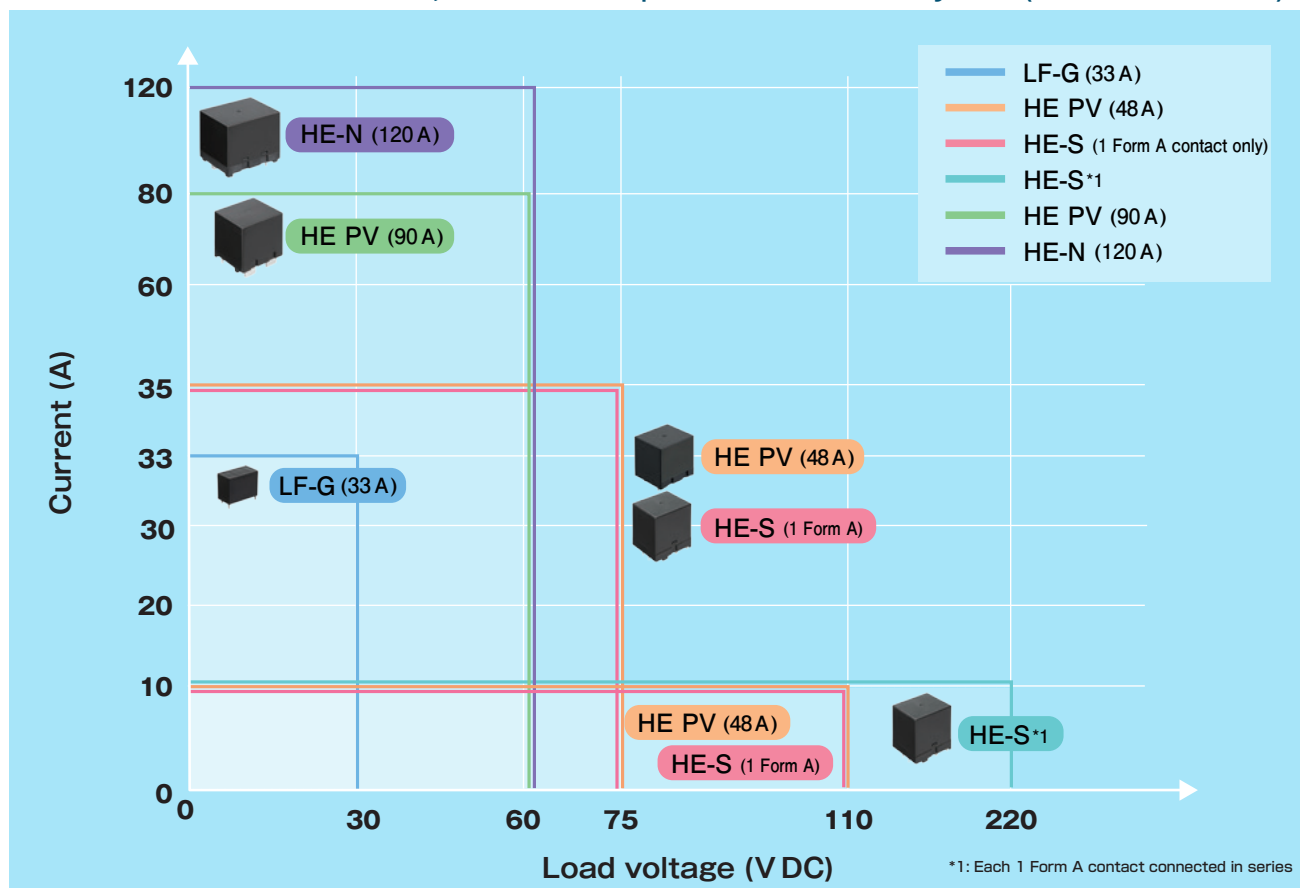

Wide variety of signal relays leading on the global market with high



Communication Network Equipment

Signal Relays

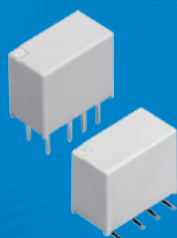

GN

- Bottom surface area 5.7 × 10.6 mm²
- Compact slim body
- High sensitivity 100 mW type



GQ

- Low profile : 5.2 mm
- Compact flat body
- High sensitivity 100 mW type

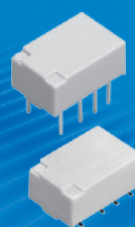

GQ (TH)

- Small size controlled 3.5 A inrush current possible

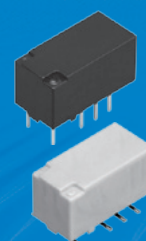

TX

- High contact capacity
- High dielectric strength

OA Equipment / Thermostat

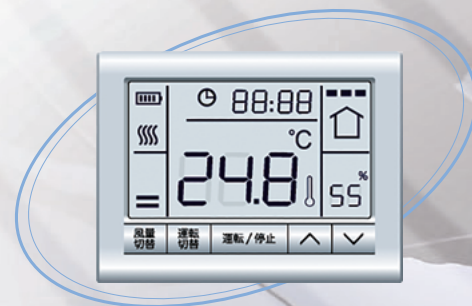

performance and quality

Signal Relays



Security



**TX
(TH)**

- Controlled 7.5 A inrush current possible

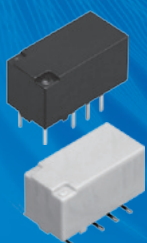

TX-S

- High sensitivity 50 mW type

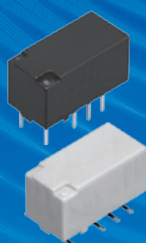

TX-D

- Surge Withstand voltage 6,000 V

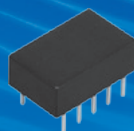

TQ

- Low profile : 5 mm



**TQ
(SMD)**

- Low profile : 5.6 mm

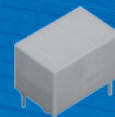

DS

- High switching capacity : 2 A

Precision / Industrial Equipment

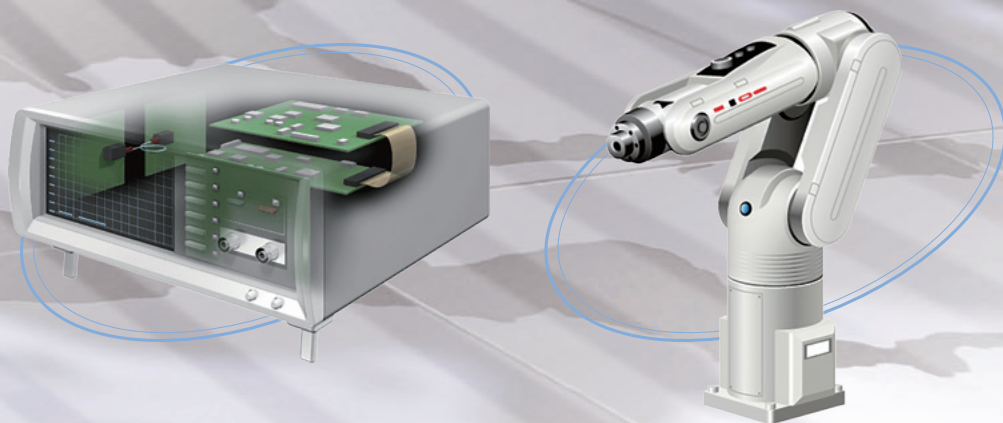

Our Superior Microwave Devices Product Lineup

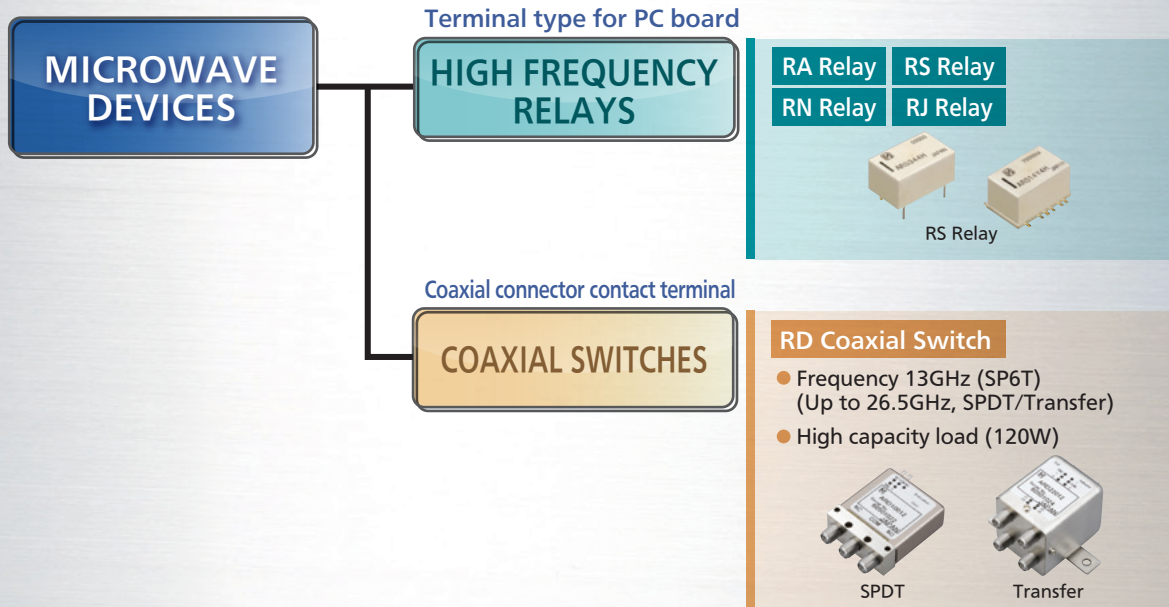



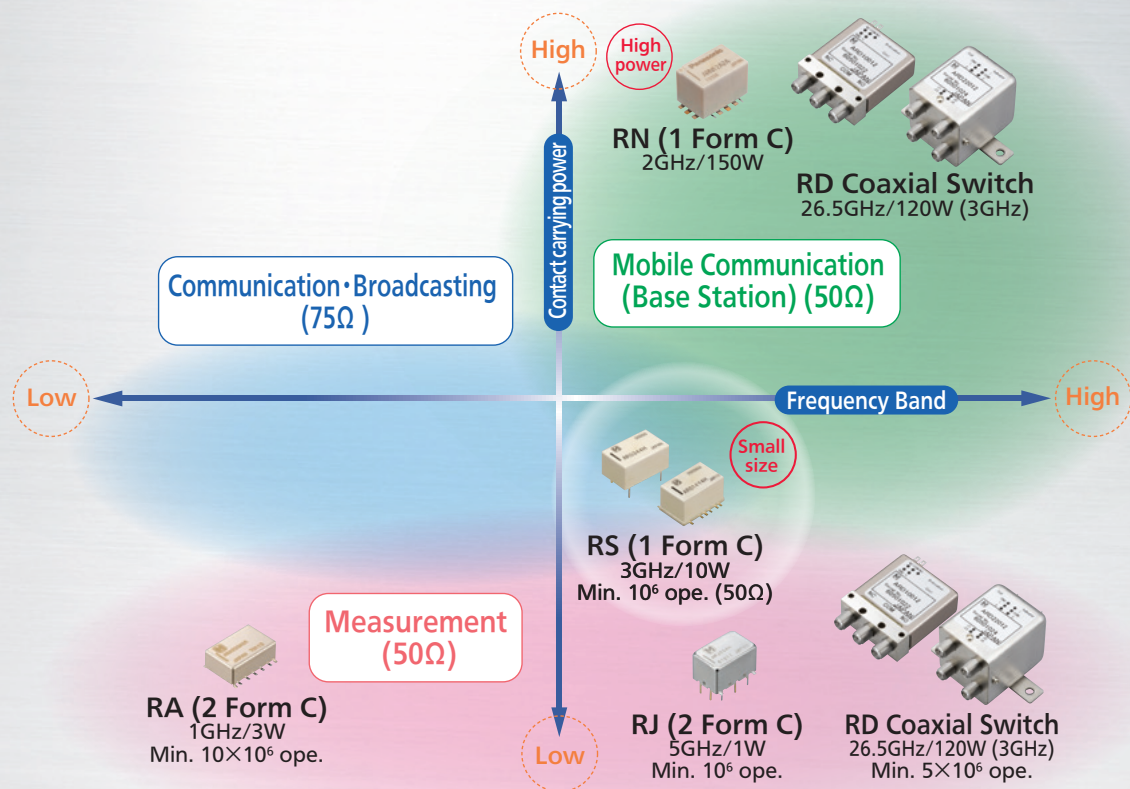

Application



Support for Wide Range of Frequencies

Microwave Devices

Product lineup

Features	Impedance (Ω)	Contact arrangement	Frequency range (GHz)							
			1	2	3	8	13	18	26.5	
RA  10 million operations For measurement equipment	50	2 Form C	█							
RJ  8GHz* ¹ capable Surface mount terminal available	50	2 Form C				█				
RS  Small size microwave relay Silent type available	50/75	1 Form C 1 Form C reversed			█					
RN  8GHz capable* ² 150W carrying power available (at 2GHz)	50	1 Form C 1 Form C reversed				█				
RD  Long life and high sensitivity coaxial switch	50	SPDT				█				
		Transfer				█				
		SP6T				█				

*1: Ratings are 5GHz
*2: Ratings are 6GHz

Lineup of Safety relays and Accessories

Rich lineup Panasonic safety relays

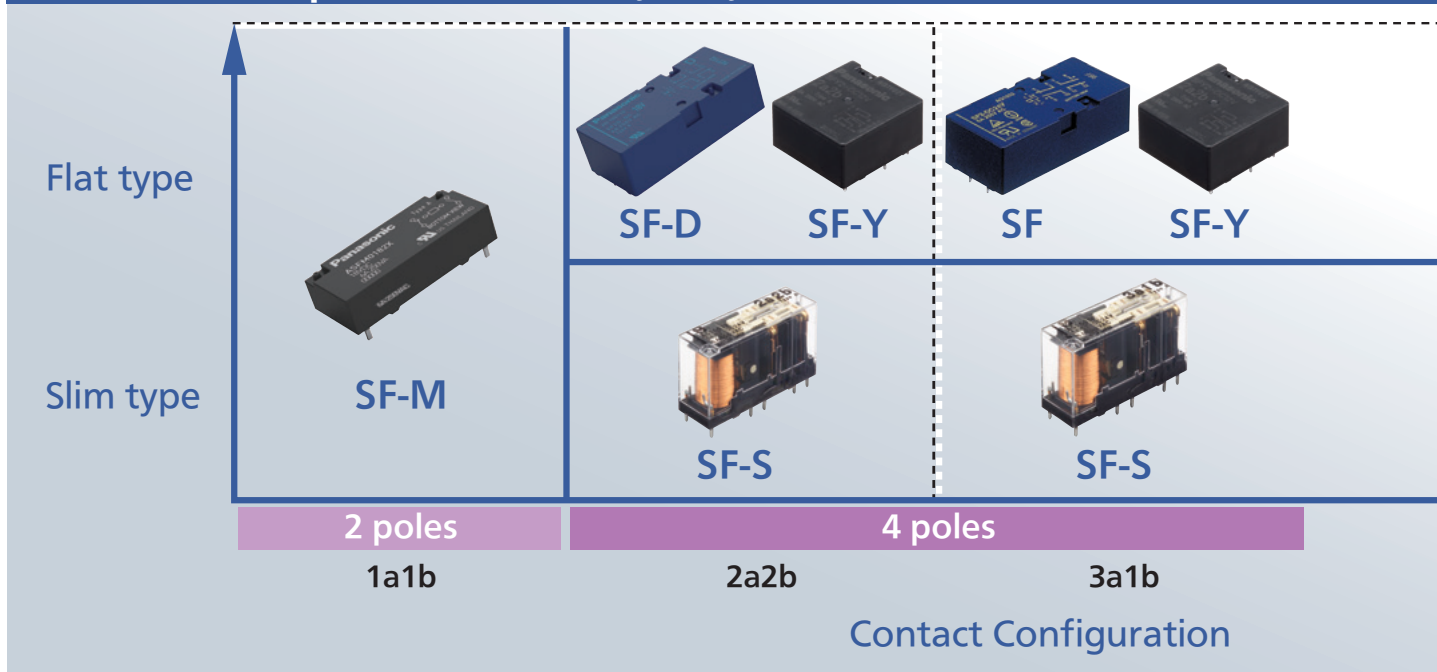

Accessories

DIN rail terminal sockets are available
 Spade and ring tongue terminal compatible
 Compatible with the following types of wire-pressed terminals

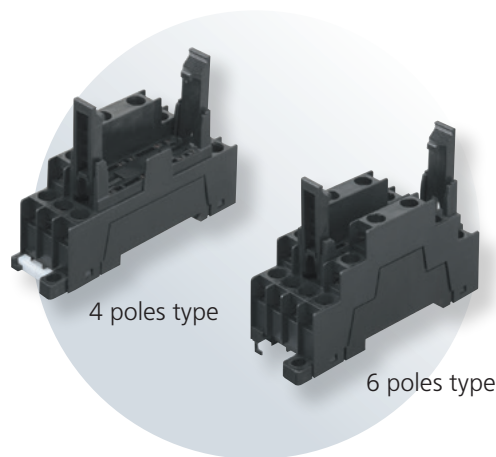
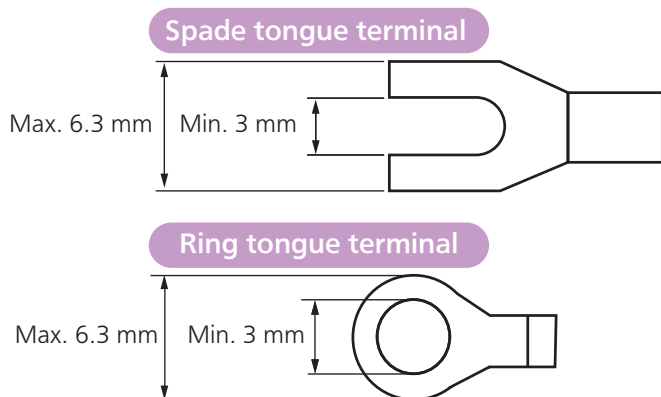

Forcibly guided contact structure

Complies with safety standard (IEC/EN61810-3)

Equipped with forcibly guided contact structure that enables detection of contact welding and construction of safety circuit.

- Designed so that contacts 1 Form A (a) and 1 Form B (b) will not close at the same time.
- Designed with at least 0.5 mm space between contacts.

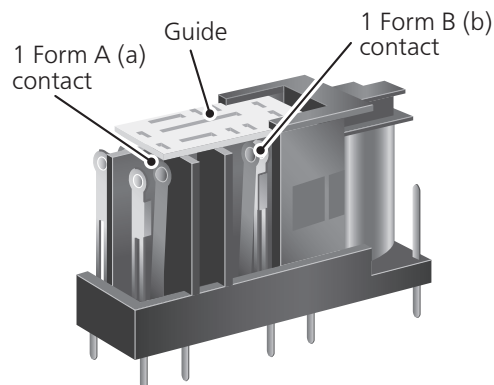

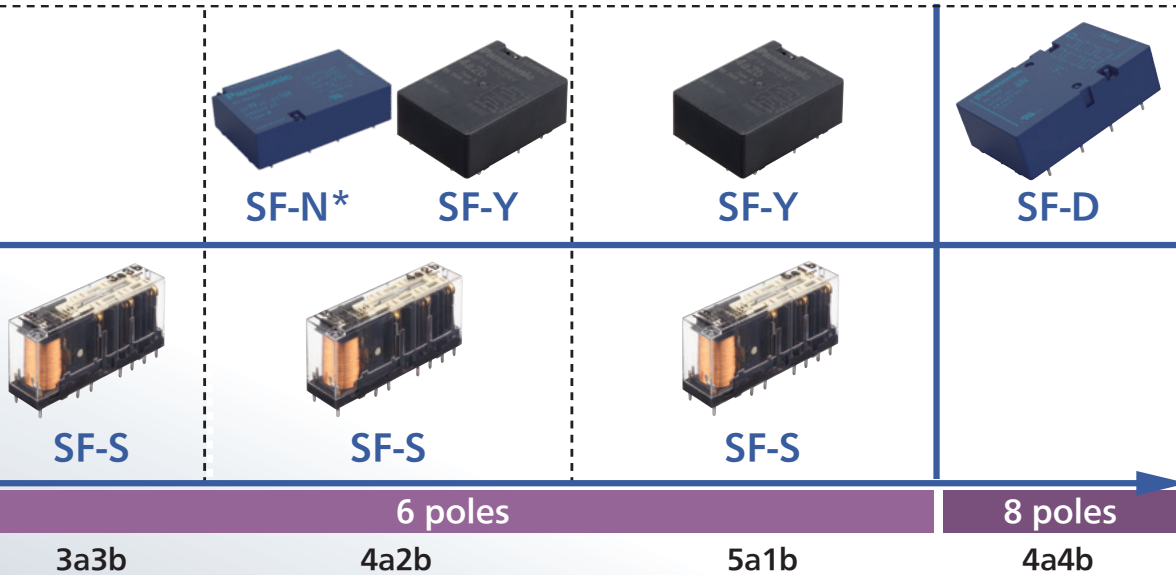

*SF-N is available for production only in Europe

(Example) – SF Relay Slim type 4a2b –

Condition	Coil	
	De-energized	Energized
Normal		
Abnormal		

Other contact gaps when contacts are welded

		State of other contacts					
		3-4 (b contact)	5-6 (b contact)	7-8 (a contact)	9-10 (a contact)	11-12 (a contact)	13-14 (a contact)
Welded contact No.	3-4 (b contact)	—	—	>0.5	>0.5	>0.5	>0.5
	5-6 (b contact)	—	—	>0.5	>0.5	>0.5	>0.5
	7-8 (a contact)	>0.5	>0.5	—	—	—	—
	9-10 (a contact)	>0.5	>0.5	—	—	—	—
	11-12 (a contact)	>0.5	>0.5	—	—	—	—
	13-14 (a contact)	>0.5	>0.5	—	—	—	—

>0.5: contact gap is kept at min. 0.5 mm .020 inch
Empty cells: either ON or OFF — : welded contact

Note: The table above shows the state of the other contacts.
In case of form a contact weld the coil applied voltage is "Non-energized".
In case of form b contact weld the coil applied voltage is nominal (energized).

Note: Contact gaps are shown at the initial state.
If the contact transfer is caused by load switching, it is necessary to check the actual loading.

Schematic (BOTTOM VIEW)
Standard

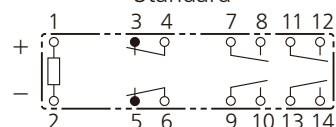

Power Relays (Over 2A) selector chart

[Order of products: Max.contact rating (small to large)]

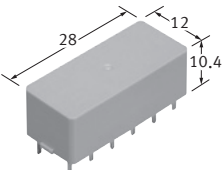
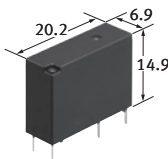
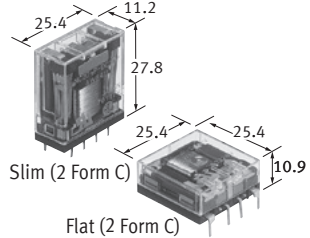
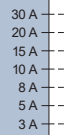
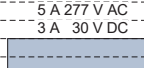
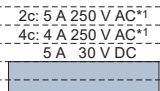
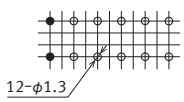
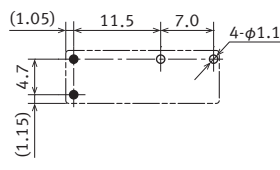
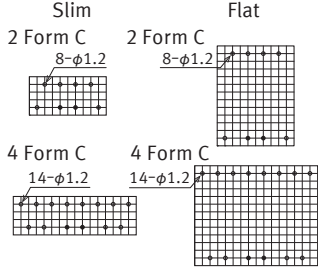
Category		Power Relays (~5 A)		
Product name		S RELAYS	LD-P RELAYS	NC RELAYS
Type of relay (Height includes standoff unit = mm)				
Initial of part number		AG3	ALDP	AW8
Features		<ul style="list-style-type: none"> • 2 Form A 2 Form B/3 Form A 1 Form B/4 Form A 4A polarized power relays 	<ul style="list-style-type: none"> • Compliant with IEC/EN60335-1/ EN60079-15 (VDE approved) • 1 Form A 5A slim power relays 	<ul style="list-style-type: none"> • Transistor drive • 2 Form C/4 Form C 5A slim power relays
Contact data	Contact arrangement	2 Form A 2 Form B, 3 Form A 1 Form B, 4 Form A	1 Form A	2 Form C, 4 Form C
	Contact shape	Twin	Single	Twin
	Contact material	Double layer contact of AgNi-AgSnO ₂ type +Au clad	AgNi type	AgNi type +Au clad
	Contact rating (resistive)			
	Min. switching load (reference value)	100 μA 100 mV DC	100 mA 5 V DC	100 μA 1 V DC
	Max. switching voltage	250 V AC, 48 V DC	277 V AC, 30 V DC	250 V AC, 220 V DC
Latching types availability		•	-	-
Coil data	Rated operating power	200 mW	200 mW	360 mW (2 Form C)* ² , 720 mW (4 Form C)* ²
	Operate [Set] voltage (initial)	Max.70% V	Max.75% V	Max.80% V
	Release [Reset] voltage (initial)	Min.10% V [Max.70% V]	Min.5% V	Min.10% V
Time Characteristics (initial)	Operate [Set] time (initial)	Max.15 ms	Max.10 ms	Max.20 ms
	Release [Reset] time (initial)	Max.10 ms [Max.15 ms]	Max.10 ms (with diode)	Max.10 ms
Expected life	Mechanical life (ope.)	Min.100 x10 ⁶	Min.5 x10 ⁶	Min.50 x10 ⁶
Dielectric strength (initial)	Between open contacts	750 V rms for 1 min	750 V rms for 1 min	1,000 V rms for 1 min
	Between contact sets	1,000 V rms for 1 min	-	1,000 V rms for 1 min
	Between contact and coil	1,500 V rms for 1 min	4,000 V rms for 1 min	2,000 V rms for 1 min
Surge withstand voltage (between contact and coil) (initial)		-	10,000 V	-
Ambient temperature		-55 to +65°C	-40 to +85°C	-40 to +70°C (2 Form C)* ² -40 to +55°C (4 Form C)
Protective construction	Dust cover	-	-	•
	Flux-resistant	-	-	-
	Sealed	•	•	•
PC board pattern (BOTTOM VIEW) • indicates input terminal 2.54mm grid		<p>Single side stable</p> 		<p>Slim Flat</p> 
Safety standards		UL, CSA	UL/C-UL, VDE, CQC (Excluding Class F insulation)	UL, CSA
Unit weight (Approx.)		8 g	4 g	16 g (2 Form C), 19 g (4 Form C: slim), 18 g (4 Form C: Flat)
Option		Socket	-	Socket, Terminal socket
Remarks		-	-	*1: Dust cover *2: Max.48 V DC

Power Relays (Over 2A) selector chart

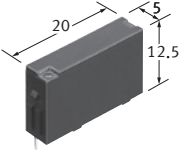
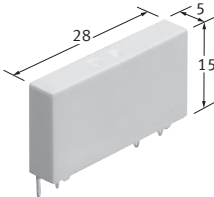
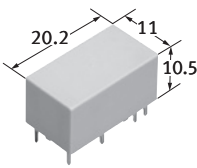
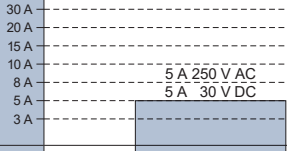
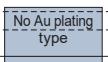
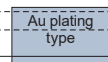
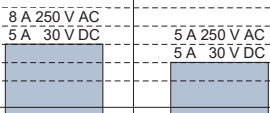
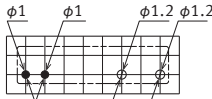
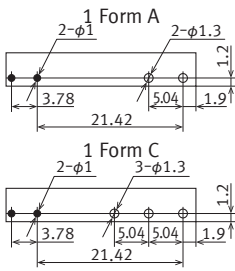
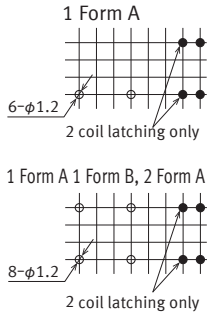
Category		Power Relays (~5 A)	Power Relays (~10 A)		
Product name		PA-N RELAYS	PF RELAYS	DS-P RELAYS	
Type of relay (Height includes standoff unit = mm)					
Initial of part number		APAN3	APF	AGP	
Features		• 1 Form A 5A Slim power relays meet IEC61010 reinforced insulation	• Compliant with European standards • 1 Form A/1 Form C 6A Slim power relays	• 1 Form A 8A (AC) 5A(DC), 1 Form A 1 Form B/2 Form A 5A (AC/DC) small polarized power relays	
Contact data	Contact arrangement	1 Form A	1 Form A, 1 Form C		
	Contact shape	Twin	Single		
	Contact material	AgNi type +Au	AgNi type, AgNi type +Au plated		
	Contact rating (resistive)				
	Min. switching load (reference value)	100 μA 100m V DC	100 mA 5 V DC	1 mA 1 V DC	10 mA 5 V DC
	Max. switching voltage	250 V AC, 110 V DC (0.4 A)	250 V AC		250 V AC, 125 V DC (0.2 A)
	Latching types availability	-	-		•
Coil data	Rated operating power	110 mW	170 mW (4.5 to 24 V DC) 217 mW (48 V DC), 175 mW (60 V DC)		
	Operate [Set] voltage (initial)	Max.70% V	Max.70% V		
	Release [Reset] voltage (initial)	Min.5% V	Min.5% V		
Time Characteristics (initial)	Operate [Set] time (initial)	Max.10 ms	Max.8 ms		
	Release [Reset] time (initial)	Max.5 ms	Max.4 ms		
Expected life	Mechanical life (ope.)	Min.20×10 ⁶	Min.5 x10 ⁶		
Dielectric strength (initial)	Between open contacts	1,000 V rms for 1 min	1,000 V rms for 1 min		
	Between contact sets	-	-		
	Between contact and coil	3,000 V rms for 1 min	4,000 V rms for 1 min		
Surge withstand voltage (between contact and coil) (initial)		6,000 V	6,000 V		
Ambient temperature		-40 to +90°C	-40 to +85°C		
Protective construction	Dust cover	-	-		
	Flux-resistant	-	-		
	Sealed	•	•		
PC board pattern (BOTTOM VIEW) • indicates input terminal 2.54mm grid					
Safety standards		UL/C-UL, VDE	UL/C-UL, VDE		
Unit weight (Approx.)		3 g	5 g		
Option		Socket	-		
Remarks		-	-		
					

Power Relays (Over 2A) selector chart

Category		Power Relays (~10 A)					
Product name		DW RELAYS		ST RELAYS		DE RELAYS	
Type of relay (Height includes standoff unit = mm)							
Initial of part number		ADW		AR2		ADE	
Features		<ul style="list-style-type: none"> • 1 Form A 8A/16A (TV-8 rated)*, small polarized power relays 		<ul style="list-style-type: none"> • TV-3 rated • 1 Form A 1 Form B/2 Form A 8A polarized power relays 		<ul style="list-style-type: none"> • Meet European standards • 1 Form A/2 Form A/1 Form A 1 Form B 10A/8A polarized power relays 	
Contact data	Contact arrangement	1 Form A		1 Form A 1 Form B, 2 Form A		1 Form A 1 Form B, 2 Form A	
	Contact shape	Single		Single		Single	
	Contact material	AgSnO ₂ type		AgSnO ₂ type +Au flashed		AgSnO ₂ type	
	Contact rating (resistive)						
	Min. switching load (reference value)	100 mA 5 V DC		100 mA 5 V DC		100 mA 5 V DC	
	Max. switching voltage	250 V AC, 277 V AC		250 V AC, 30 V DC		250 V AC, 30 V DC	
Latching types availability		● (Latching type only)		●		●	
Coil data	Rated operating power	200 mW (1 coil latching) 400 mW (2 coil latching)		Approx 240 mW		200 mW	
	Operate [Set] voltage (initial)	Max.80% V		Max.80% V		Max.70% V	
	Release [Reset] voltage (initial)	Max.80% V		Min.10% V [Max.80% V]		Min.10% V [Max.70% V]	
Time Characteristics (initial)	Operate [Set] time (initial)	Max.15 ms		Max.15 ms		Max.10 ms	
	Release [Reset] time (initial)	Max.15 ms		Max.10 ms [Max.15 ms]		Max.5 ms [Max.10 ms]	
Expected life	Mechanical life (ope.)	Min.10 ⁶		Min.10 x10 ⁶		Min.10 x10 ⁶	
Dielectric strength (initial)	Between open contacts	1,000 V rms for 1 min		1,200 V rms for 1 min		1,000 V rms for 1 min	
	Between contact sets	-		2,000 V rms for 1 min		-	
	Between contact and coil	5,000 V rms for 1 min		3,750 V rms for 1 min		5,000 V rms for 1 min	
Surge withstand voltage (between contact and coil) (initial)		12,000 V		6,000 V		12,000 V	
Ambient temperature		-40 to +85°C (Max.8 A) -40 to +70°C (Max.8 to 16 A)		-40 to +60°C		-40 to +70°C	
Protective construction	Dust cover	-		-		-	
	Flux-resistant	●		-		-	
	Sealed	-		●		●	
PC board pattern (BOTTOM VIEW) ● indicates input terminal 2.54mm grid							
Safety standards		UL/C-UL, VDE, CQC		UL, CSA, VDE		UL/C-UL, VDE	
Unit weight (Approx.)		8 g (Low profile type: 7.5 g)		10 g		7 g	
Option		-		Socket		-	
Remarks		* TV-8 rated and inrush type: 16 A only		-		-	



Power Relays (Over 2A) selector chart

Category		Power Relays (~10 A)				
Product name		DK RELAYS		DY RELAYS		LQ RELAYS
Type of relay (Height includes standoff unit = mm)						
Initial of part number		AW3		ADY		ALQ
Features		<ul style="list-style-type: none"> 1 Form A 10A, 1 Form A 1 Form B/2 Form A 8A small polarized power relays 		<ul style="list-style-type: none"> 1 Form A 10A, 1 Form A 1 Form B 8A small polarized power relays 		<ul style="list-style-type: none"> Compliant with IEC/EN60335-1* /EN60079-15 (VDE approved) 1 Form A/1 Form C 10A small power relays
Contact data	Contact arrangement	1 Form A	1 Form A 1 Form B, 2 Form A	1 Form A	1 Form A 1 Form B	1 Form A, 1 Form C
	Contact shape	Single		Single		Single
	Contact material	AgSnO ₂ type + Au flashed	AgNi type + Au flashed	AgSnO ₂ type + Au flashed		AgNi type
	Contact rating (resistive)					
	Min. switching load (reference value)	10 mA 5 V DC	10 mA 5 V DC	10 mA 5 V DC	10 mA 5 V DC	100 mA 5 V DC
	Max. switching voltage	250 V AC, 125 V DC (0.2 A)		250 V AC, 125 V DC (0.2 A)		250 V AC, 30 V DC
Latching types availability		●		●		—
Coil data	Rated operating power	200 mW		200 mW		200 mW (1 Form A), 400 mW (1 Form C)
	Operate [Set] voltage (initial)	Max.70% V		Max.70% V		Max.75% V
	Release [Reset] voltage (initial)	Min.10% V [Max.70% V]		Min.10% V [Max.70% V]		Min.5% V
Time Characteristics (initial)	Operate [Set] time (initial)	Max.10 ms		Max.10 ms		Max.20 ms
	Release [Reset] time (initial)	Max.8 ms [Max.10 ms]		Max.8 ms [Max.10 ms]		Max.20 ms (With diode)
Expected life	Mechanical life (ope.)	Min.50 x10 ⁶		Min.50 x10 ⁶		Min.10 x10 ⁶
Dielectric strength (initial)	Between open contacts	1,000 V rms for 1 min		1,000 V rms for 1 min		1,000 V rms for 1 min (1 Form A), 750 V rms for 1 min (1 Form C)
	Between contact sets	—	4,000 V rms for 1 min	—	4,000 V rms for 1 min	—
	Between contact and coil	4,000 V rms for 1 min		4,000 V rms for 1 min		4,000 V rms for 1 min
Surge withstand voltage (between contact and coil) (initial)		10,000 V		10,000 V		8,000 V
Ambient temperature		-40 to +65°C		-40 to +70°C		-40 to +85°C
Protective construction	Dust cover	—		—		—
	Flux-resistant	—		—		—
	Sealed	●		●		●
PC board pattern (BOTTOM VIEW) ● indicates input terminal 2.54mm grid		 		 		
Safety standards		UL, CSA, (VDE: special order only)		UL, CSA, VDE		UL/C-UL, VDE, CQC
Unit weight (Approx.)		5 g	6 g	6 g		7 g
Option		Socket		Socket		—
Remarks		—		—		*1 Form A type is compatible except for the bottom surface

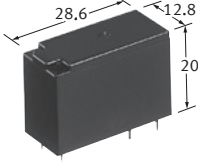
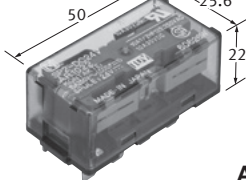
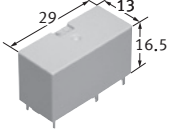
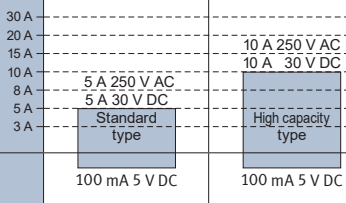
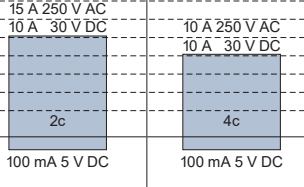
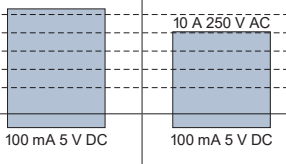
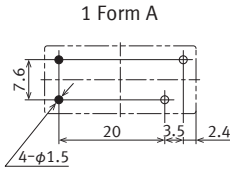
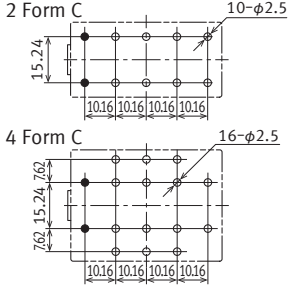
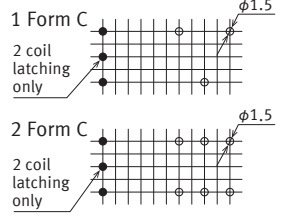
Power Relays (Over 2A) selector chart

Category		Power Relays (~10 A)		Power Relays (~20 A)			
Product name		JW RELAYS		SP RELAYS		DJ RELAYS	
Type of relay (Height includes standoff unit = mm)							
Initial of part number		AJW		AR1		ADJ	
Features		<ul style="list-style-type: none"> TV-5 rated (1a)* 1 Form A/1 Form C/2 Form A/2 Form C 5A/10A universal power relays 		<ul style="list-style-type: none"> 2 Form C 15A, 4 Form C 10A polarized power relays 		<ul style="list-style-type: none"> 1-pole/2-pole 16A polarized power relays Clearance and creepage distance is Min.8mm (Contact and coil) 	
Contact data	Contact arrangement	1 Form A, 1 Form C, 2 Form A, 2 Form C	1 Form A, 1 Form C	2 Form C	4 Form C	1 Form C, 1 Form A, 1 Form B	1 Form A 1 Form B, 2 Form C, 2 Form A, 2 Form B
	Contact shape	Single		Twin		Single	
	Contact material	1 Form A: AgSnO ₂ type 1 Form C, 2 Form A, 2 Form C: AgNi type		Stationary: AgSnO ₂ type +Au flashed Movable: AgSnO ₂ type		AgSnO ₂ type	AgSnO ₂ type + Au flashed
	Contact rating (resistive)						
	Min. switching load (reference value)	100 mA 5 V DC		100 mA 5 V DC		100 mA 5 V DC	100 mA 5 V DC
	Max. switching voltage	250 V AC, 30 V DC		250 V AC, 30 V DC		250 V AC	
Latching types availability		-		•		•	
Coil data	Rated operating power	530 mW		300 mW		150 mW (1 coil latching) 250 mW (Single side stable, 2 coil latching)	
	Operate [Set] voltage (initial)	Max.70% V		Max.70% V		Max.75% V [Max.70% V]	
	Release [Reset] voltage (initial)	Min.10% V		Min.10% V [Max.70% V]		Min.10% V [Max.70% V]	
Time Characteristics (initial)	Operate [Set] time (initial)	Max.15 ms		Max.50 ms		Max.20 ms	
	Release [Reset] time (initial)	Max.5 ms		Max.20 ms [Max.50 ms]		Max.20 ms	
Expected life	Mechanical life (ope.)	Min.5 x10 ⁶		Min.50 x10 ⁶		Min.5 x10 ⁶	
Dielectric strength (initial)	Between open contacts	1,000 V rms for 1 min		1,500 V rms for 1 min		1,000 V rms for 1 min	
	Between contact sets	3,000 V rms for 1 min (2 poles)	-	3,000 V rms for 1 min		-	2,000 V rms for 1 min
	Between contact and coil	5,000 V rms for 1 min		3,000 V rms for 1 min		4,000 V rms for 1 min	
Surge withstand voltage (between contact and coil) (initial)		10,000 V		-		10,000 V	
Ambient temperature		-40 to +60°C (Class E) -40 to +85°C (Class B)		-50 to +60°C		-40 to +70°C	
Protective construction	Dust cover	-		•		-	
	Flux-resistant	•		-		•	
	Sealed	•		-		•*	
PC board pattern (BOTTOM VIEW) • indicates input terminal 2.54mm grid							
Safety standards		UL, CSA, VDE, CQC (AJW7211 only)		UL, CSA, VDE		UL/C-UL, VDE, CQC	
Unit weight (Approx.)		13 g		50 g	65 g	14 g	
Option		Socket		Terminal socket, Mounting board			
Remarks		* Please contact our sales representative for details		-			
				Test button type is available * Please contact our sales representative for details			

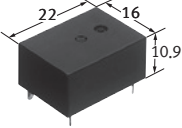
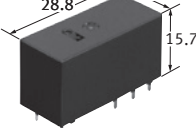
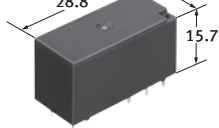
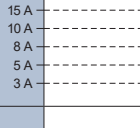
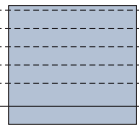
Power Relays (Over 2A) selector chart

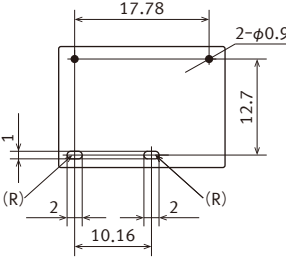
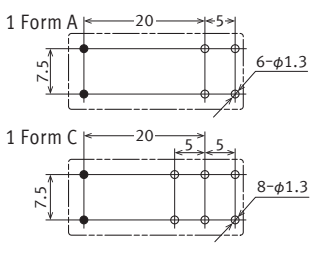
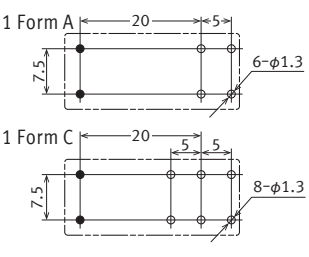
Category		Power Relays (~20 A)		
Product name		JV-N RELAYS	LZ RELAYS	LZ-N RELAYS
Type of relay (Height includes standoff unit = mm)				
Initial of part number		AJVN	ALZ	ALZN
Features		• 1 Form A 16A, low profile: 10.9 mm power relays for heater control	• TV-5 rated • Low profile: 15.7mm height 1 Form A/1 Form C 16A power relays	• TV-5 rated and meet EN60335-1 GWT Low profile: 15.7mm height 1 Form A/1 Form C 16A power relays
Contact data	Contact arrangement	1 Form A	1 Form A, 1 Form C	1 Form A, 1 Form C
	Contact shape	Single	Single	Single
	Contact material	AgSnO ₂ type	AgSnO ₂ type	AgSnO ₂ type
	Contact rating (resistive)	16 A 125 V AC 10 A 277 V AC 10 A 30 V DC 	16 A 250 V AC 	16 A 250 V AC 
	Min. switching load (reference value)	100 mA 5 V DC	100 mA 5 V DC	100 mA 5 V DC
	Max. switching voltage	277 V AC, 110 V DC (0.3 A)	440 V AC	440 V AC
Latching types availability		-	-	-
Coil data	Rated operating power	200 mW (4.5 to 48 V DC) 600 mW (100 V DC)	400 mW	400 mW
	Operate [Set] voltage (initial)	Max.75% V (4.5 to 48 V DC) Max.60 V DC (100 V DC)	Max.70% V	Max.70% V
	Release [Reset] voltage (initial)	Min.5% V (4.5 to 48 V DC) Min.4 V DC (100 V DC)	Min.10% V	Min.10% V
Time Characteristics (initial)	Operate [Set] time (initial)	Max.12 ms (4.5 to 48 V DC) Min.8 ms (100 V DC)	Max.15 ms	Max.15 ms
	Release [Reset] time (initial)	Max.5 ms	Max.5 ms	Max.5 ms
Expected life	Mechanical life (ope.)	Min. 20 x10 ⁶	Min.10 x10 ⁶	Min.10 ⁶
Dielectric strength (initial)	Between open contacts	1,000 V rms for 1 min	1,000 V rms for 1 min	1,000 V rms for 1 min
	Between contact sets	-	-	-
	Between contact and coil	2,500 V rms for 1 min	5,000 V rms for 1 min	5,000 V rms for 1 min
Surge withstand voltage (between contact and coil) (initial)		4,500 V	10,000 V	10,000 V
Ambient temperature		-40 to +70°C, -40 to +60°C (100 V DC)	-40 to +85°C (Class B) -40 to +105°C (Class F)	-40 to +85°C (Class B) -40 to +105°C (Class F)
Protective construction	Dust cover	-	-	-
	Flux-resistant	•	•	•
	Sealed	-	•*	-
PC board pattern (BOTTOM VIEW) • indicates input terminal			 1 Form A 1 Form C	 1 Form A 1 Form C
Safety standards		UL, CSA, VDE	UL/C-UL, VDE	UL/C-UL, VDE
Unit weight (Approx.)		8 g	12 g	11 g
Option		-	-	-
Remarks		-	* Please contact our sales representative for details	-

Power Relays (Over 2A) selector chart

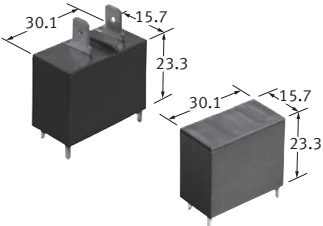
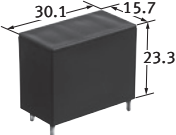
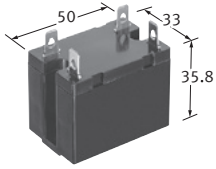
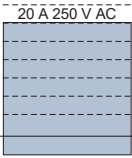
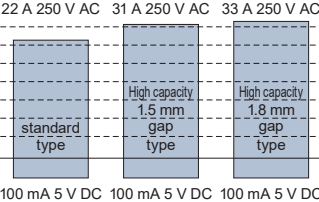
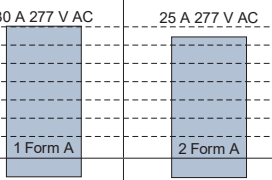
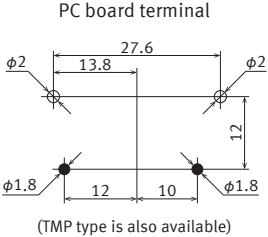
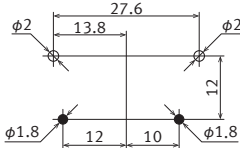
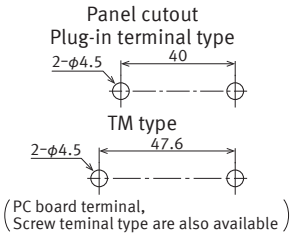
Category		Power Relays (~20 A)	Power Relays (~30 A)	
Product name		LF RELAYS	LF-G RELAYS	HE RELAYS
Type of relay (Height includes standoff unit = mm)				
Initial of part number		ALF	ALFG	AHE
Features		<ul style="list-style-type: none"> • TV-8 rated • 1 Form A 20A power relays for compress or and inverter load 	<ul style="list-style-type: none"> • 1 Form A 22A/33A Compact power relays for solar inverter load 	<ul style="list-style-type: none"> • TV-10/TV-15 rated • 1 Form A 30A, 2 Form A 25A power relays
Contact data	Contact arrangement	1 Form A	1 Form A	1 Form A 2 Form A
	Contact shape	Single	Single	Single
	Contact material	AgSnO ₂ type	AgSnO ₂ type	AgSnO ₂ type
	Contact rating (resistive)			
	Min. switching load (reference value)	100 mA 5 V DC	100 mA 5 V DC 100 mA 5 V DC 100 mA 5 V DC	100 mA 5 V DC 100 mA 5 V DC
	Max. switching voltage	250 V AC	250 V AC	277 V AC, 30 V DC
Latching types availability		-	-	-
Coil data	Rated operating power	900 mW	1.4 W	1.7 to 2.7 VA (AC) , 1.92 W (DC)
	Operate [Set] voltage (initial)	Max.70% V	Max.70% V	Max.70% V
	Release [Reset] voltage (initial)	Min.10% V	Min.10% V	Min.15% V (AC) , Min.10% V (DC)
Time Characteristics (initial)	Operate [Set] time (initial)	Max.20 ms	Max.20 ms	Max.30 ms
	Release [Reset] time (initial)	Max.15 ms (With diode)	Max.10 ms	Max.30 ms (AC) , Max.10 ms (DC)
Expected life	Mechanical life (ope.)	Min.2 x 10 ⁶	Min.10 ⁶ (Contact gap: 1.5 mm) Min.500 x 10 ³ (Contact gap: 1.8 mm)	Min.5 x 10 ⁶ (AC) Min.10 x 10 ⁶ (DC)
Dielectric strength (initial)	Between open contacts	1,000 V rms for 1 min	2,500 V rms for 1 min	2,000 V rms for 1 min
	Between contact sets	-	-	4,000 V rms for 1 min
	Between contact and coil	5,000 V rms for 1 min	4,000 V rms for 1 min	5,000 V rms for 1 min
Surge withstand voltage (between contact and coil) (initial)		10,000 V	6,000 V	10,000 V
Ambient temperature		-40 to +60°C	-40 to +60°C, -40 to +85°C*	-50 to +55°C
Protective construction	Dust cover	-	-	•
	Flux-resistant	•	•	• (PC board terminal)
	Sealed	-	-	-
PC board pattern (BOTTOM VIEW) • indicates input terminal				
Safety standards		UL/C-UL, VDE	UL/C-UL, VDE	UL, CSA, VDE, CQC
Unit weight (Approx.)		23 g	23 g	80 to 120 g
Option		-	-	Terminal socket
Remarks		-	* Coil holding voltage is 45 to 85%V	-

Power Relays (Over 2A) selector chart

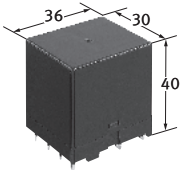
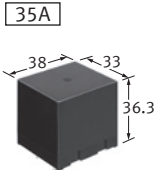
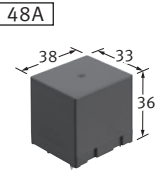
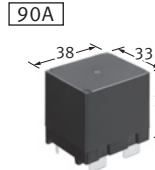
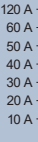
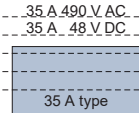
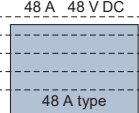
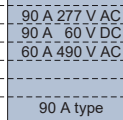
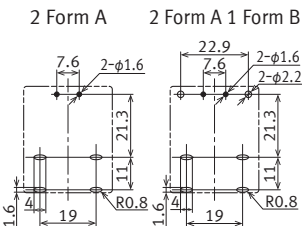
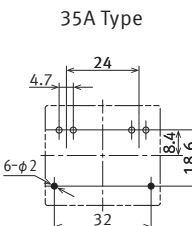
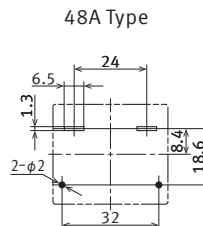
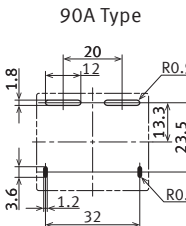
Category		Power Relays (30 A~)				
Product name		HE-S RELAYS		HE RELAYS PV TYPE		
Type of relay (Height includes standoff unit = mm)				  		
Initial of part number		AHES		AHE		
Features		<ul style="list-style-type: none"> • TV-8 / TV-10 rated • 2 Form A/2 Form A 1 Form B 40A compact power relays 		<ul style="list-style-type: none"> • 1 Form A 35A/48A/90A compact power relays for inverter 		
Contact data	Contact arrangement	2 Form A, 2 Form A 1 Form B		1 Form A		
	Contact shape	Single		Single		
	Contact material	AgSnO ₂ type (Form A) AgNi type +Au flashed (Form B)		AgSnO ₂ type (35 A)	AgNi type (48 A/90 A)	
	Contact rating (resistive)	 40 A 277 V AC Form A		 35 A type	 48 A type	 90 A type
	Min. switching load (reference value)	100 mA 5 V DC		100 mA 5 V DC	100 mA 5 V DC	100 mA 5 V DC
	Max. switching voltage	480 V AC, 110 V DC		490 V AC, 48 V DC		490 V AC
Latching types availability		-		-		
Coil data	Rated operating power	1.88 W		1.92 W		
	Operate [Set] voltage (initial)	Max.75% V		Max.70% V		
	Release [Reset] voltage (initial)	Min.5% V		Min.10% V		
Time Characteristics (initial)	Operate [Set] time (initial)	Max.30 ms		Max.30 ms		
	Release [Reset] time (initial)	Max.10 ms		Max.10 ms		
Expected life	Mechanical life (ope.)	Min.5 x 10 ⁶		Min.10 x 10 ⁶ (35 A/48 A)	Min.10 ⁶ (90 A)	
Dielectric strength (initial)	Between open contacts	2,000 V rms for 1 min (Between open Form A contacts)		2,000 V rms for 1 min		
	Between contact sets	5,000 V rms for 1 min (Between Form A contact sets)		-		
	Between contact and coil	5,000 V rms for 1 min (Between Form A contact and coil)		5,000 V rms for 1 min		
Surge withstand voltage (between contact and coil) (initial)		10,000 V (Between Form A contact and coil)		10,000 V		
Ambient temperature		-40 to 70°C (Max. carrying current 40 A) -40 to 85°C (Max. carrying current 35 A, transport and storage) *		-50 to +55°C, -50 to +85°C*		
Protective construction	Dust cover	-		-		
	Flux-resistant	●		●		
	Sealed	-		-		
PC board pattern (BOTTOM VIEW) ● indicates input terminal						
Safety standards		UL/C-UL, VDE, CQC		UL, CSA, VDE	UL/C-UL, VDE	
Unit weight (Approx.)		64 g		80 g	85 g	
Option		-		-		
Remarks		* When using at 55°C or higher, the coil holding voltage should be 30 to 60% V.		* Coil holding voltage is 50 to 60% V		

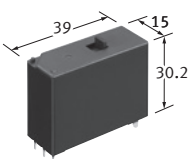
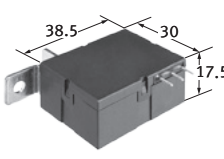
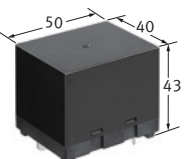
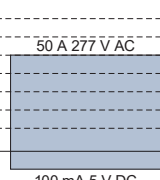
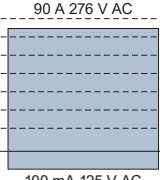
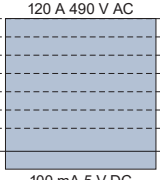
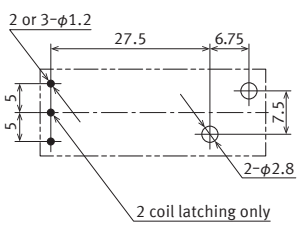
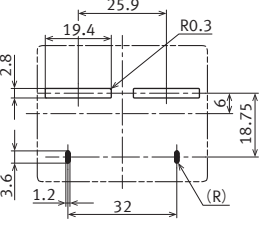

Power Relays (Over 2A) selector chart

Category		Power Relays (30 A~)		
Product name		DJ-H RELAYS	DZ-S RELAYS	HE-N RELAYS
Type of relay (Height includes standoff unit = mm)				
Initial of part number		ADJH	ADZS	AHE6
Features		• 1 Form A 50A latching relays for lighting and motor load	• Meet IEC62055-31 UC3 1 Form A 90A power latching relays	• High capacity 120A 490V AC 1 Form A power relays
Contact data	Contact arrangement	1 Form A	1 Form A	1 Form A
	Contact shape	Single	Single	Single
	Contact material	AgSnO ₂ type	AgSnO ₂ type	AgNi type
	Contact rating (resistive)			
	Min. switching load (reference value)	100 mA 5 V DC	100 mA 125 V AC	100 mA 5 V DC
Max. switching voltage		480 V AC	276 V AC	800 V AC
Latching types availability		• (Latching only)	• (Latching only)	-
Coil data	Rated operating power	1 W (1 coil latching) 2 W (2 coil latching)	1.5 W (1 coil latching) 3 W (2 coil latching)	2.5 W
	Operate [Set] voltage (initial)	Max. 75% V	Max. 70% V	Max. 75% V
	Release [Reset] voltage (initial)	Max. 75% V	Max. 70% V	Min. 5% V
Time Characteristics (initial)	Operate [Set] time (initial)	Max. 20 ms	Max. 20 ms	Max. 30 ms
	Release [Reset] time (initial)	Max. 20 ms	Max. 20 ms	Max. 10 ms
Expected life	Mechanical life (ope.)	Min. 10 ⁶	Min. 100 x 10 ³	Min. 10 ⁶
Dielectric strength (initial)	Between open contacts	1,500 V rms for 1 min	2,000 V rms for 1 min	2,000 V rms for 1 min
	Between contact sets	-	-	-
	Between contact and coil	4,000 V rms for 1 min	4,000 V rms for 1 min	5,000 V rms for 1 min
Surge withstand voltage (between contact and coil) (initial)		12,000 V	12,000 V	10,000 V
Ambient temperature		-40 to +85°C	-40 to +85°C	-40 to +55°C*1 -40 to +85°C*2
Protective construction	Dust cover	-	•	-
	Flux-resistant	•	-	•
	Sealed	-	-	-
PC board pattern (BOTTOM VIEW) • indicates input terminal			-	
Safety standards		UL/C-UL, VDE	-	UL/C-UL, VDE
Unit weight (Approx.)		31 g	45 g	115 g
Option		-	-	-
Remarks		Reverse polarity type is available	IEC62055-31 UC3	*1: Coil holding voltage is 40 to 100%V (at 20°C) *2: Coil holding voltage is 50 to 60%V (at 85°C)

Power Relays (Over 2A) selector chart

Category		Power Relays (30 A~)
Product name		HE-R RELAYS
Type of relay (Height includes standoff unit = mm)		
Initial of part number		4 Form A 1 Form B AHER
Features		<ul style="list-style-type: none"> • Compact size 4 Form A and 1 Form B 40A power relays for EVSE and industrial equipment
Contact data	Contact arrangement	4 Form A, 4 Form A 1 Form B
	Contact shape	Single
	Contact material	Form A contact: AgSnO ₂ type Form B contact: Au plated AgNi type
	Contact rating (resistive)	
	Min. switching load (reference value)	Form A contact: 100 mA 24 V DC Form B contact: 10 mA 5 V DC
	Max. switching voltage	480 V AC
Latching types availability		-
Coil data	Rated operating power	4 W
	Operate [Set] voltage (initial)	Max. 75% V
	Release [Reset] voltage (initial)	Max. 5% V
Time Characteristics (initial)	Operate [Set] time (initial)	Max. 50 ms
	Release [Reset] time (initial)	Max. 30 ms
Expected life	Mechanical life (ope.)	Min. 100 x 10 ⁵
Dielectric strength (initial)	Between open contacts	2,000 Vrms for 1 min (Between open Form A contacts)
	Between contact sets	5,000 V rms for 1 min (Between Form A contact sets)
	Between contact and coil	5,000 V rms for 1 min (Between Form A contact and coil)
Surge withstand voltage (between contact and coil) (initial)		10,000 V (Between From A contact and coil)
Ambient temperature		-40 to 55°C, -40 to 85°C *
Protective construction	Dust cover	-
	Flux-resistant	●
	Sealed	-
PC board pattern (BOTTOM VIEW) ● indicates input terminal		
Safety standards		UL/C-UL, VDE
Unit weight (Approx.)		approx. 180 g
Option		-
Remarks		* Coil holding voltage is 35 to 50% V

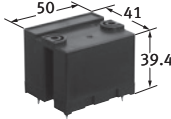
High-capacity DC cut off Relays selector chart

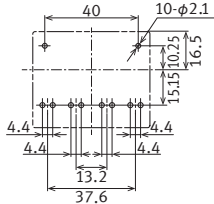
Category		High-capacity DC cut off relays	
Product name		HE-V RELAYS	
Type of relay (Height includes standoff unit = mm)			
Initial of part number		AHEV	
Features		<ul style="list-style-type: none"> High capacity Max. 1,000 V DC, 20 A cut-off power relay 	
Contact data	Contact arrangement	2 Form A	
	Contact shape	Single	
	Contact material	AgNi type	
	Contact rating (resistive)	100 A 80 A 60 A 40 A 20 A 10 A 5 A	
Min. switching load (reference value)		100 mA 5 V DC	
Latching types availability		-	
Coil data	Rated operating power	1.92 W	
	Operate [Set] voltage (initial)	Max. 70% V	
	Release [Reset] voltage (initial)	Min. 5% V	
Time Characteristics (initial)	Operate [Set] time (initial)	Max. 30 ms	
	Release [Reset] time (initial)	Max. 10 ms	
Expected life	Mechanical life (ope.)	Min. 10 ⁶	
Dielectric strength (initial)	Between open contacts	2,000 V rms for 1 min	
	Between contact sets	4,000 V rms for 1 min	
	Between contact and coil	5,000 V rms for 1 min	
Surge withstand voltage (between contact and coil) (initial)		10,000 V	
Ambient temperature		-40 to +55°C -40 to +85°C *2	
Protective construction	Dust cover	-	
	Flux-resistant	●	
	Sealed	-	
PC board pattern (BOTTOM VIEW) ● indicates input terminal			
Safety standards		UL/C-UL, VDE	
Unit weight (Approx.)		120 g	
Option socket		-	
Remarks		*1: Each 1 Form A contact connected in series *2: When coil holding voltage is 33 to 60% of rated coil voltage	

Signal Relays (2 A or less) selector chart

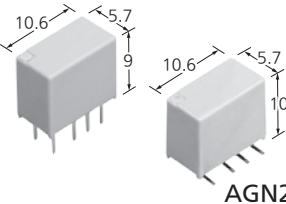
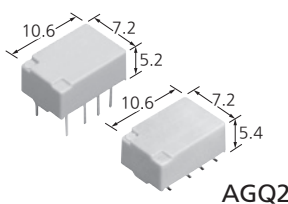
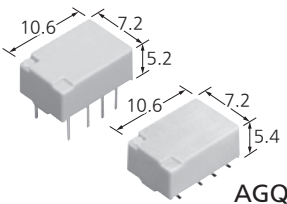
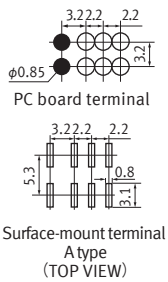
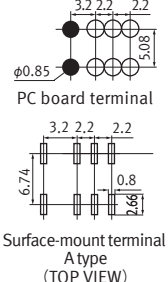
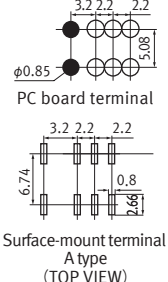
Category		Signal Relays (2 A or less)		
Product name		GN RELAYS	GQ RELAYS	GQ RELAYS (TH type)
Type of relay (Height includes standoff unit: mm)				
Initial of part number		AGN2	AGQ2	AGQ2
Features		<ul style="list-style-type: none"> High sensitivity 100 mW type 2 Form C and 1 A Compact, Slim body type relays 	<ul style="list-style-type: none"> High sensitivity 100 mW type 2 Form C and 1 A Compact flat body type relays 	<ul style="list-style-type: none"> Small size controlled 3.5 A inrush current possible 2.4 V coil voltage type newly available DC battery operation
Contact data	Contact arrangement	2 Form C	2 Form C	2 Form C
	Contact shape	Crossbar Twin	Crossbar Twin	Crossbar Twin
	Contact material	Stationary: AgPd + Au-clad Movable : AgPd	Stationary: AgPd + Au-clad Movable : AgPd	AgNi + Au-plating
	Contact rating (resistive)	4 A 3 A 2 A 1 A	2 A 30 V DC	2 A 30 V DC
	Min. switching load (reference value)	10 μA 10 mV DC	10 μA 10 mV DC	10 μA 10 mV DC
Latching types availability		●	●	●
Coil data	Rated coil voltage	1.5, 3, 4.5, 6, 9, 12, 24 V DC	1.5, 3, 4.5, 6, 9, 12, 24 V DC	1.5, 2.4, 3, 4.5, 6, 9, 12, 24 V DC
	Rated operating power	Single side stable: 140 mW (1.5 to 12 V DC), 230 mW (24 V DC) Latching type & High sensitivity: 100 mW (1.5 to 12 V DC), 120 mW (24 V DC)	Single side stable: 140 mW (1.5 to 12 V DC), 230 mW (24 V DC) Latching type & High sensitivity: 100 mW (1.5 to 12 V DC), 120 mW (24 V DC)	Single side stable: 140 mW (1.5 to 12 V DC), 230 mW (24 V DC) Latching type: 100 mW (1.5 to 12 V DC), 120 mW (24 V DC)
	Operate [Set] voltage (initial)	Max. 75% V, Max. 80% V (High sensitivity)	Max. 75% V, Max. 80% V (High sensitivity)	Max. 75 % V [Max. 75 % V]
	Release [Reset] voltage (initial)	Min. 10% V [Max. 75% V]	Min. 10% V [Max. 75% V]	Min. 10% V [Max. 75% V]
Time characteristics (initial)	Operate [Set] time (initial)	Max. 4 ms	Max. 4 ms	Max. 4 ms
	Release [Reset] time (initial)	Max. 4 ms	Max. 4 ms	Max. 4 ms
Expected life	Mechanical life (ope.)	Min. 50 × 10 ⁶	Min. 50 × 10 ⁶	Min. 50 × 10 ⁶
Dielectric strength (initial)	Between open contacts	750 Vrms for 1 min	750 Vrms for 1 min	750 Vrms for 1 min
	Between contact and coil	1,500 Vrms for 1 min	1,500 Vrms for 1 min	1,500 Vrms for 1 min
	Between contact sets	1,000 Vrms for 1 min	1,000 Vrms for 1 min	1,000 Vrms for 1 min
Surge withstand voltage (initial)	Between open contacts	1,500 V 10 × 160 μs (FCC Part 68)	1,500 V 10 × 160 μs (FCC Part 68)	1,500 V (10 × 160 μs) (FCC Part 68)
	Between contact and coil	2,500 V 2 × 10 μs	2,500 V 2 × 10 μs	2,500 V 2 × 10 μs (Telcordia)
Ambient temperature		-40 to +85 °C/ -40 to +70 °C (High sensitivity)	-40 to +85 °C/ -40 to +70 °C (High sensitivity)	-40 to +85 °C
Protective construction	Dust cover	—	—	—
	Flux-resistant	—	—	—
	Sealed	●	●	●
PC board pattern (BOTTOM VIEW) ● indicates input terminal				
Safety standards		UL/C-UL, BSI	UL/C-UL, BSI	UL/C-UL, BSI
Unit weight (Approx.)		1 g	1 g	1 g
Option		—	—	—
Remarks		—	—	—

Signal Relays (2 A or less) selector chart

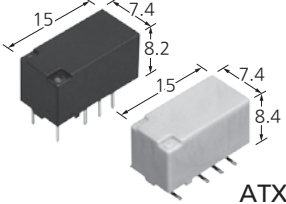
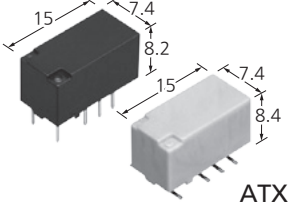
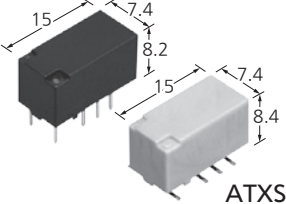
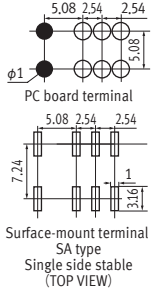
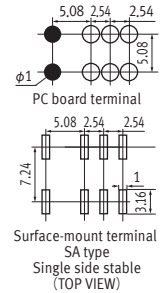
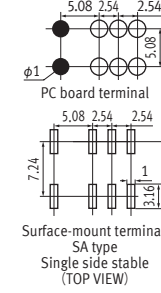
Category		Signal Relays (2 A or less)		
Product name		TX RELAYS	TX RELAYS (TH type)	TX-S RELAYS
Type of relay (Height includes standoff unit: mm)				
Initial of part number		ATX2	ATX2	ATXS2
Features		<ul style="list-style-type: none"> • 2,000 V rms dielectric strength • 2 Form C and 2 A relays 	<ul style="list-style-type: none"> • Controlled 7.5 A inrush current possible • 2 Form C Compact body type relays 	<ul style="list-style-type: none"> • High sensitivity 50 mW type • 2 Form C and 1 A Compact body type relays
Contact data	Contact arrangement	2 Form C	2 Form C	2 Form C
	Contact shape	Crossbar Twin	Crossbar Twin	Crossbar Twin
	Contact material	Standard: Ag + Au-clad	Ag + Au-plating	Standard: Ag + Au-clad
	Contact rating (resistive)	4 A 3 A 2 A 1 A	2 A 30 V DC	1 A 30 V DC
	Min. switching load (reference value)	10 μA 10 mV DC	10 μA 10 mV DC	10 μA 10 mV DC
Latching types availability		●	●	●
Coil data	Rated coil voltage	1.5, 3, 4.5, 5, 6, 9, 12, 24, 48 V DC (48 V ; Only single side stable type)	1.5, 2.4, 3, 4.5, 5, 6, 9, 12, 24, 48 V DC (48 V ; Only single side stable type, 2.4 V ; Only latching type)	1.5, 3, 4.5, 6, 9, 12, 24 V DC
	Rated operating power	Single side stable: 140 mW (1.5 to 24 V DC), 270 mW (48 V DC) Latching type: 200 mW (1.5 to 24 V DC)	Single side stable: 140 mW (1.5 to 24 V DC), 270 mW (48 V DC) Latching type: 140 mW (1.5 to 24 V DC)	Single side stable: 50 mW (1.5 to 12V DC), 70 mW (24 V DC) Latching type: 70 mW (1.5 to 12V DC), 150 mW (24 V DC)
	Operate [Set] voltage (initial)	Max. 75% V	Max. 75% V	Max. 80% V
	Release [Reset] voltage (initial)	Min. 10% V [Max. 75% V]	Min. 10% V [Max. 75% V]	Min. 10% V [Max. 80% V]
Time characteristics (initial)	Operate [Set] time (initial)	Max. 4 ms	Max. 4 ms	Max. 5 ms
	Release [Reset] time (initial)	Max. 4 ms	Max. 4 ms	Max. 5 ms
Expected life	Mechanical life (ope.)	Min. 100 × 10 ⁶	Min. 100 × 10 ⁶	Min. 50 × 10 ⁶
Dielectric strength (initial)	Between open contacts	1,000 Vrms for 1 min	1,000 Vrms for 1 min	750 Vrms for 1 min
	Between contact and coil	2,000 Vrms for 1 min	2,000 Vrms for 1 min	1,800 Vrms for 1 min
	Between contact sets	1,000 Vrms for 1 min	1,000 Vrms for 1 min	1,000 Vrms for 1 min
Surge withstand voltage (initial)	Between open contacts	1,500 V 10 × 160 μs (FCC Part 68)	1,500 V 10 × 160 μs (FCC Part 68)	1,500 V 10 × 160 μs (FCC Part 68)
	Between contact and coil	2,500 V 2 × 10 μs	2,500 V 2 × 10 μs	2,500 V 2 × 10 μs
Ambient temperature		-40 to +85 °C (1.5 to 24 V DC) / -40 to +70 °C (48 V DC)	-40 to +85 °C (1.5 to 24 V DC) / -40 to +70 °C (48 V DC)	-40 to +70 °C
Protective construction	Dust cover	—	—	—
	Flux-resistant	—	—	—
	Sealed	●	●	●
PC board pattern (BOTTOM VIEW) ● indicates input terminal				
Safety standards		UL/C-UL, BSI	UL/C-UL, BSI	UL/C-UL, BSI
Unit weight (Approx.)		2 g	2 g	2 g
Option		—	—	—
Remarks		—	—	—

Signal Relays (2 A or less) selector chart

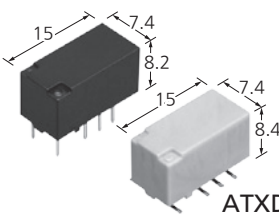
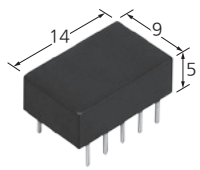
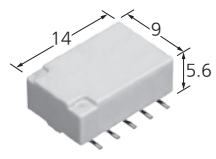
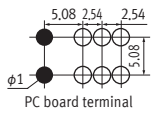
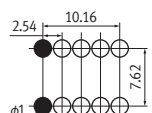
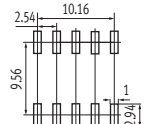
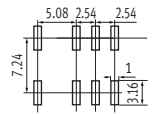
Category		Signal Relays (2 A or less)			
Product name		TX-D RELAYS	TQ RELAYS*	TQ RELAYS (SMD)	
Type of relay (Height includes standoff unit: mm)					
Initial of part number		ATXD2	ATQ	ATQ	
Features		<ul style="list-style-type: none"> 6,000 V Surge withstand voltage type 2 Form A, 2 A and High dielectric strength type relays 	<ul style="list-style-type: none"> 5 mm Low profile 2 Form C, 1 A type relays 	<ul style="list-style-type: none"> 5.6 mm Low profile 2 Form C 2 A Surface-mount type relays 	
Contact data	Contact arrangement	2 Form C	2 Form C	2 Form C	
	Contact shape	Crossbar Twin	Crossbar Twin	Crossbar Twin	
	Contact material	Standard: Ag + Au-clad	Ag + Au-clad	AgNi + Au-clad	
	Contact rating (resistive)	4 A 3 A 2 A 1 A	2 A 30 V DC	1 A 30 V DC	2 A 30 V DC
	Min. switching load (reference value)	10 μA 10 mV DC	10 μA 10 mV DC	10 μA 10 mV DC	
Latching types availability		●	●	●	
Coil data	Rated coil voltage	1.5, 3, 4.5, 6, 9, 12, 24 V DC	3, 4.5, 5, 6, 9, 12, 24, 48 V DC (48 V ; Only single side stable type)	1.5, 3, 4.5, 5, 6, 9, 12, 24, 48 V DC (48 V ; Only single side stable type)	
	Rated operating power	2 Form C Single side stable: 200 mW (1.5 to 12 V DC), 230 mW (24 V DC) 2 Form C Latching type: 150 mW (1.5 to 12 V DC), 170 mW (24 V DC)	2 Form C Single side stable: 140 mW (3 to 12 V DC) 200 mW (24 V DC), 300 mW (48 V DC)	Single side stable: 140 mW (1.5 to 12 V DC) 200 mW (24 V DC), 300 mW (48 V DC)	
	Operate [Set] voltage (initial)	Max. 75% V	Max. 75% V	Max. 75% V	
	Release [Reset] voltage (initial)	Min. 10% V [Max. 75% V]	Min. 10% V [Max. 75% V]	Min. 10% V [Max. 75% V]	
Time characteristics (initial)	Operate [Set] time (initial)	Max. 4 ms	Max. 3 ms	Max. 4 ms	
	Release [Reset] time (initial)	Max. 4 ms	Max. 3 ms	Max. 4 ms	
Expected life	Mechanical life (ope.)	Min. 100 × 10 ⁶	Min. 100 × 10 ⁶	Min. 100 × 10 ⁶	
Dielectric strength (initial)	Between open contacts	1,000 Vrms for 1 min	750 Vrms for 1 min	1,000 Vrms for 1 min	
	Between contact and coil	3,000 Vrms for 1 min	1,000 Vrms for 1 min	1,500 Vrms for 1 min	
	Between contact sets	1,000 Vrms for 1 min	1,000 Vrms for 1 min	1,500 Vrms for 1 min	
Surge withstand voltage (initial)	Between open contacts	1,500 V 10 × 160 μs (FCC Part 68)	1,500 V 10 × 160 μs (FCC Part 68)	1,500 V 10 × 160 μs (FCC Part 68)	
	Between contact and coil	6,000 V 1.2 × 50 μs	—	2,500 V 2 × 10 μs	
Ambient temperature		−40 to +85°C	−40 to +70 °C	−40 to +85 °C (1 A or less for use over 70 °C)	
Protective construction	Dust cover	—	—	—	
	Flux-resistant	—	—	—	
	Sealed	●	●	●	
PC board pattern (BOTTOM VIEW) ● indicates input terminal	PC board terminal				
	Surface-mount terminal SA type Single side stable (TOP VIEW)				
Safety standards		UL/C-UL, BSI	UL/C-UL	UL/C-UL	
Unit weight (Approx.)		2 g	1.5 g	2 g	
Option		—	—	—	
Remarks		MBB contact available	MBB contact available	—	

* Standard PC board terminal and self-clinching terminal.

Signal Relays (2 A or less) selector chart

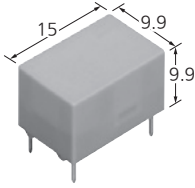
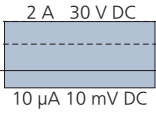
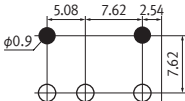
Category		Signal Relays (2 A or less)
Product name		DS RELAYS
Type of relay (Height includes standoff unit: mm)		
Initial of part number		AG2
Features		<ul style="list-style-type: none"> • High sensitivity 200 mW type • 1 Form C, 2 A type relays
Contact data	Contact arrangement	1 Form C
	Contact shape	Twin
	Contact material	Ag + Au-clad
	Contact rating (resistive)	4 A 3 A 2 A 1 A
	Min. switching load (reference value)	 2 A 30 V DC 10 μA 10 mV DC
Latching types availability		●
Coil data	Rated coil voltage	1.5, 3, 5, 6, 9, 12, 24, 48 V DC
	Rated operating power	Single side stable: 400 mW (Standard), 200 mW (High sensitivity) Latching type: 360 mW (Standard), 180 mW (High sensitivity)
	Operate [Set] voltage (initial)	Max. 70% V, Max. 80% V (High sensitivity)
	Release [Reset] voltage (initial)	Min. 10% V [Max. 70% V, Max. 80% V (High sensitivity)]
Time characteristics (initial)	Operate [Set] time (initial)	Max. 10 ms
	Release [Reset] time (initial)	Max. 5 ms [Max. 10 ms]
Expected life	Mechanical life (ope.)	Min. 100 × 10 ⁶ (Single side stable), Min. 10 × 10 ⁶ (2 coil latching)
Dielectric strength (initial)	Between open contacts	1,000 Vrms for 1 min (Standard), 500 Vrms for 1 min (High sensitivity)
	Between contact and coil	1,500 Vrms for 1 min (Standard), 1,000 Vrms for 1 min (High sensitivity)
	Between contact sets	—
Surge withstand voltage (initial)	Between open contacts	—
	Between contact and coil	—
Ambient temperature		−40 to +70 °C
Protective construction	Dust cover	—
	Flux-resistant	—
	Sealed	●
PC board pattern (BOTTOM VIEW) ● indicates input terminal		 PC board terminal Single side stable
Safety standards		UL, CSA
Unit weight (Approx.)		3 g
Option		—
Remarks		—

Microwave Devices Selector Chart

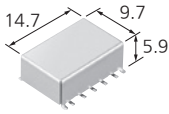
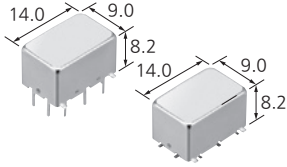
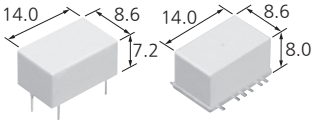
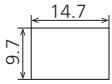
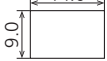
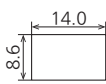
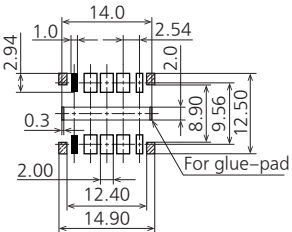
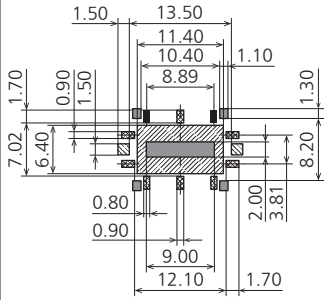
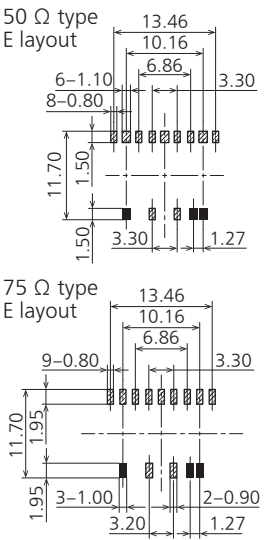
Category		Microwave Devices		
Product name		RA RELAYS	RJ RELAYS	RS RELAYS
Type of relay (Height includes standoff unit = mm)				
Initial of part number		ARA	ARJ	ARS
Features		1 GHz capable, 3 W carrying power (at 1 GHz), 50 Ω impedance and 2 Form C relays	8 GHz max. capable, 1 W carrying power (at 5 GHz), 50 Ω impedance and 2 Form C relays	3 GHz capable, 10 W carrying power (at 3 GHz), 50 W/75 Ω impedance and 1 Form C relays
Contact data	Contact arrangement	2 Form C	2 Form C	1 Form C
	Contact material	Ag alloy / Au-clad Ag alloy	Au	Au
	Contact input power	3 W (at 1 GHz)	1 W (at 5 GHz)	10 W (at 3 GHz)
Latching types availability		●	●	●
Coil data	Rated coil voltage	1.5, 3, 4.5, 5, 6, 9, 12, 24, 48 V DC (48 V: Only single side stable)	3, 4.5, 12, 24 V DC	3, 4.5, 9, 12, 24 V DC
	Rated operating power	140 mW (1.5 to 12 V) 200 mW (24 V) 300 mW (48 V)	(Single) 200 mW (-L2) 150 mW	(Single) 200 mW (-L) 200 mW (-L2) 400 mW
	Operate [Set] voltage (initial)	Max. 75 % V	Max. 75 % V	Max. 75 % V
	Release [Reset] voltage (initial)	Min. 10 % V	Min. 10 % V	Min. 10 % V
Operate [Set] time (initial)		Max. 4 ms (about 2 ms)	Max. 5 ms	Max. 10 ms
Release [Reset] time (initial)		Max. 4 ms (about 1 ms)	Max. 5 ms	Max. 6 ms
Expected life	Mechanical life	Min. 100×10 ⁶	Min. 10×10 ⁶	Min. 5×10 ⁶
	Electrical life	Min. 10×10 ⁶	Min. 10 ⁶	Min. 300×10 ³ (75 Ω) Min. 10 ⁶ (50 Ω)
Surge withstand voltage (initial)	Between open contacts	750 V rms for 1 min	500 V rms for 1 min	500 V rms for 1 min
	Between contact and coil	1,000 V rms for 1 min	500 V rms for 1 min	1,000 V rms for 1 min
Ambient temperature		-40 to +85 °C	-30 to +70 °C	-40 to +70 °C -40 to +60 °C (silent)
Protective construction	Dust cover	-	-	-
	Flux-resistant	-	-	-
	Sealed	●	●	●
Dimensions	Height (Height includes standoff unit = mm)	5.9	8.2	8
	Bottom (mm)			
PC board pattern (TOP VIEW) ■ indicates input terminal				
		■: Earth for metal case	■: Relay terminals ■: Ground. Note that soldering is required. ■: Ground. Note that you must determine the necessity of solder based on effect of heat when soldering. ■: Ground. Note that some extra work is required due to the effect of lifting when soldering.	
Safety standards		-	-	-
Unit weight (Approx.)		2 g	3 g	2 g
Option		-	-	-
Remarks		-	-	Reverse contact type available.

Microwave Devices Selector Chart

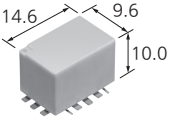
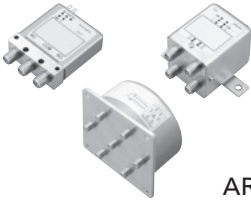
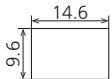
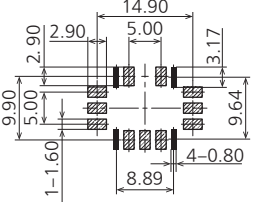
Category		Microwave Devices	
Product name		RN RELAYS	RD COAXIAL SWITCHES
Type of relay (Height includes standoff unit = mm)			
Initial of part number		ARN	ARD
Features		8 GHz max. capable, 150 W carrying power (at 2 GHz), compact SMD type, 50 Ω impedance and 1 Form C relays	26.5 GHz max. coaxial switches coming in SPDT, Transfer, and SP6T types
Contact data	Contact arrangement	1 Form C	SPDT, Transfer, SP6T
	Contact material	Au	Au
	Contact input power	Max. 150 W (at 2 GHz)	Max. 120 W (at 3 GHz)
Latching types availability		●	●
Coil data	Rated coil voltage	4.5, 12, 24 V DC	4.5, 5, 12, 24 V DC (4.5 V: Excepting Latching with TTL driver , 5 V: Latching with TTL driver)
	Rated operating power	(Single) 320 mW (-L2) 400 mW	(SPDT, SP6T) 840 mW (Transfer) 1,540 mW
	Operate [Set] voltage (initial)	Max. 75 % V	-
	Release [Reset] voltage (initial)	Min. 10 % V	-
Operate [Set] time (initial)		Max. 5 ms	Max. 15 ms (SPDT) Max. 20 ms (Transfer, SP6T)
Release [Reset] time (initial)		Max. 5 ms	-
Expected life	Mechanical life	Min. 10 ⁶	Min. 5 × 10 ⁶
	Electrical life	Min. 10 ³	Min. 5 × 10 ⁶ (SPDT)
Surge withstand voltage (initial)	Between open contacts	500 V rms for 1 min	500 V rms for 1 min
	Between contact and coil	500 V rms for 1 min	500 V rms for 1 min
Ambient temperature		-40 to +85 °C	-55 to +85 °C
Protective construction	Dust cover	-	-
	Flux-resistant	●	-
	Sealed	-	-
Dimensions	Height (Height includes standoff unit = mm)	10	-
	Bottom (mm)		-
PC board pattern (TOP VIEW) ■ indicates input terminal			-
Safety standards		-	-
Unit weight (Approx.)		2.5 g	-
Option		-	-
Remarks		Reverse contact type available.	-

Safety Relays Selector Chart

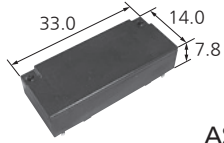
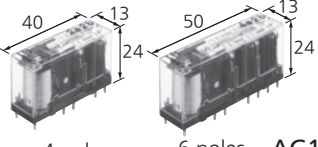
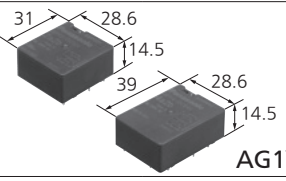
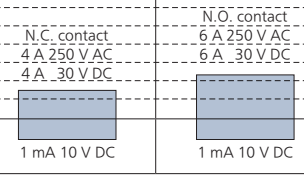
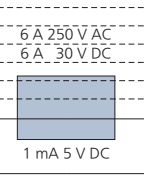
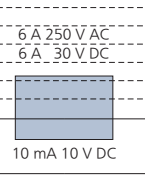
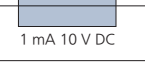
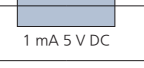
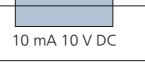
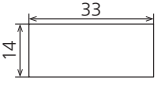
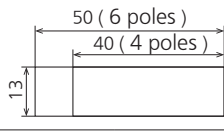
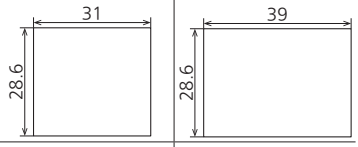
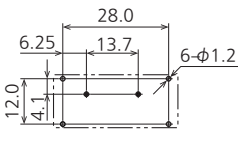
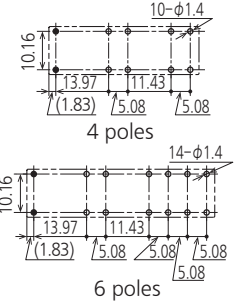
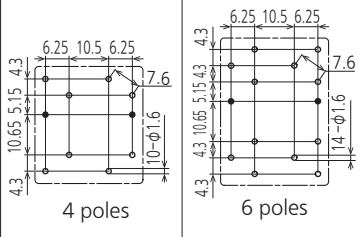
Category		Safety Relays					
Product name		SF-M RELAYS		SF RELAYS Slim type		SF-Y RELAYS	
Type of relay (Height includes standoff unit = mm)							
Initial of part number		ASFMO		4 poles 6 poles AG1S		AG1Y0	
Features		Flat type safety relays (1 Form A 1 Form B)		Slim type safety relays		Compact Relay Family with Forcibly Guided Contacts	
Contact data	Contact arrangement	1 Form A 1 Form B		4 poles: 2 Form A 2 Form B, 3 Form A 1 Form B 6 poles: 4 Form A 2 Form B, 5 Form A 1 Form B, 3 Form A 3 Form B		4 poles: 2 Form A 2 Form B, 3 Form A 1 Form B 6 poles: 4 Form A 2 Form B, 5 Form A 1 Form B	
	Contact shape	Single		Single		Single	
	Contact material	RTII: Au flashed AgNi type RTIII: Au flashed AgSnO ₂ type		Au flashed AgSnO ₂ type		Au flashed AgNi type	
	Contact rating chart Maximum (cos φ = 1)						
	Minimum (For Reference)						
Latching types availability		-		-		-	
Coil data	Nominal coil voltage	3, 5, 12, 16, 18, 21, 24 V DC		12, 24, 48 V DC		5, 12, 16, 18, 21, 24 V DC	
	Rated operating power	270 mW (When input) 100 mW (When retained)		360 mW 500 mW		670 mW	
	Operate [Set] voltage (initial)	Max. 75 %		Max. 75 % V		Max. 75 % V	
	Release [Reset] voltage (initial)	Min. 10 % V		Min. 10 % V		Min. 15 % V	
Time characteristics	Operate [Set] time (initial)	Max. 15 ms		Max. 20 ms		Max. 20 ms	
	Release [Reset] time (initial)	Max. 10 ms		Max. 20 ms		Max. 10 ms	
Expected life	Mechanical life (ope.)	Min. 10×10 ⁶		Min. 10×10 ⁶		Min. 10×10 ⁶	
	Dielectric strength (initial)	Between open contacts: 1,500 Vrms for 1 min Between contact and coil: NC contact (3-4 terminal) - coil; 2,500 Vrms for 1 min; NO contact (5-6 terminal) - coil; 4,000 Vrms for 1 min		1,500 Vrms for 1 min 4,000 Vrms for 1 min		1,500 Vrms for 1 min NC contact (5-6 terminal) - coil; 2,500 Vrms for 1 min; NO contact (7-8 terminal) - coil; 4,000 Vrms for 1 min	
Surgewithstandvoltage (initial) Between contact and coil		-		-		-	
Ambient temperature		-40 to +85 °C		-40 to +85 °C		-40 to +70 °C	
Protective construction	Dust cover	-		-		-	
	Flux-resistant	● (RTII)		●		-	
	Sealed	● (RTIII)		-		● (RTIII) *1	
External dimension	height (mm) Including Standoff	7.8		24		14.5	
	Bottom (mm)						
Suggested PC board pattern (BOTTOM VIEW) ●: coil terminal							
Safety standards		UL/C-UL, TÜV		UL/C-UL, Korean S, TÜV, CQC		UL/C-UL, TÜV	
Unit weight (Approx.)		6.5 g		20 g 23 g		19 g 23 g	
Option		-		Sockets, DIN rail terminal socket		-	
Remarks		-		With LED indication type available		-	

*1: According to EN 61810-1:2015, table 2

Safety Relays Selector Chart

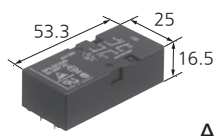
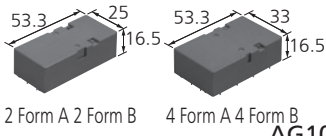
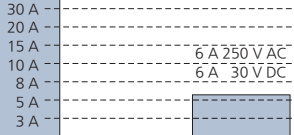
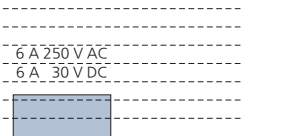
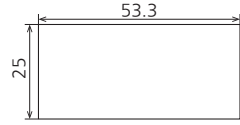
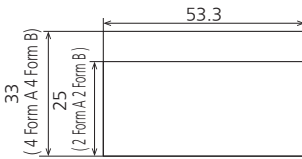
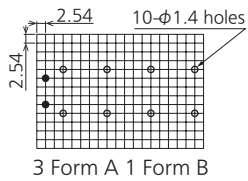
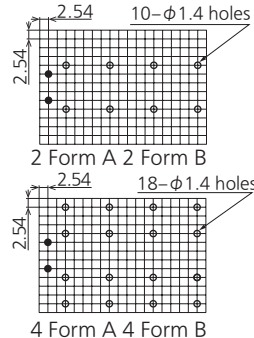
Category		Safety Relays	
Product name		SF RELAYS	SF RELAYS Double Contact Type
Type of relay (Height includes standoff unit = mm)			
Initial of part number		AG103	AG10
Features		Flat type safety relays	Flat type safety relays (double contact)
Contact data	Contact arrangement	3 Form A 1 Form B	2 Form A 2 Form B 4 Form A 4 Form B
	Contact shape	Single	Double Contact
	Contact material	Au flashed AgSnO ₂ type	Au flashed AgSnO ₂ type
	Contact rating chart Maximum (cos φ = 1)		
	Minimum (For Reference)	100 mA 5 V DC	100 mA 5 V DC
Latching types availability		-	-
Coil data	Nominal coil voltage	5, 12, 24, 48, 60 V DC	5, 12, 24, 48, 60 V DC
	Rated operating power	500 mW	500 mW
	Operate [Set] voltage (initial)	Max. 80 % V	Max. 75 % V
	Release [Reset] voltage (initial)	Min. 10 % V	Min. 10 % V
Time characteristics	Operate [Set] time (initial)	Max. 30 ms	Max. 30 ms
	Release [Reset] time (initial)	Max. 15 ms	Max. 15 ms
Expected life	Mechanical life (ope.)	Min. 10×10 ⁶	Min. 10×10 ⁶
Dielectric strength (initial)	Between open contacts	2,500 Vrms for 1 min	1,300 Vrms for 1 min
	Between contact and coil	2,500 Vrms for 1 min	2,500 Vrms for 1 min
Surgewithstandvoltage (initial) Between contact and coil		-	-
Ambient temperature		-40 to +70 °C	-40 to +70 °C
Protective construction	Dust cover	-	-
	Flux-resistant	-	-
	Sealed	●	●
External dimension	height (mm) Including Standoff	16.5	16.5
	Bottom (mm)		
Suggested PC board pattern (BOTTOM VIEW) ●: coil terminal			
Safety standards		UL/C-UL, TÜV	UL/C-UL, TÜV
Unit weight (Approx.)		38 g	38 g 47 g
Option		-	-
Remarks		-	-

Characteristics

■ UL Coil Insulation

Coil Insulation	Relay
UL-B	LQ, LZ, LZ-N, JW
UL-F	LD-P, LF-G, LQ, LZ, LZ-N, HE, HE-PV, HE-N, HE-S, HE-V

■ TV rated

TV rated	Relay
TV-2	-
TV-3	ST, LQ (1 Form A) *
TV-4	-
TV-5	LZ, LZ-N, JW
TV-8	DW (Inrush type), LF, HE-S (STD type N.O.)
TV-10	HE (2 Form A), HE-S (Long life type N.O.)
TV-15	HE (1 Form A), HE-PV (35 A)

* For TV-3 type, please contact our sales representative for details.

■ Surge voltage between contact and coil

Surge voltage	Relay
5,000 V	DS-P
6,000 V	ST, PF, LF-G, PA-N
8,000 V	LQ
10,000 V	LF, LD-P, LZ, LZ-N, JW, HE, HE-PV, HE-N, HE-S, HE-V, DJ, DK, DY, HE-R
12,000 V	DE, DW

■ High frequency characteristics

Relay	Arrangement	Isolation	Insertion loss
RD COAXIAL SWITCH	SPDT Transfer SP6T	Min. 80 dB (1 to 4 GHz) SPDT Min. 60 dB (12.4 to 18 GHz) Transfer Min. 80 dB (1 to 4 GHz) SP6T	Max. 0.2 dB (1 to 4 GHz) SPDT Max. 0.5 dB (12.4 to 18 GHz) Transfer Max. 0.2 dB (1 to 4 GHz) SP6T
RN RELAY	1 Form C	Min. 30 dB (3 to 6 GHz)	Max. 0.5 dB (3 to 6 GHz)
RJ RELAY	2 Form C	Min. 30 dB (5 GHz) (Between contact sets)	Max. 0.5 dB (5 GHz)
RA RELAY	2 Form C	Min. 30 dB (1 GHz) (Between contact sets)	Max. 0.3 dB (1 GHz)
RS RELAY	1 Form C	Min. 30 dB (3 GHz) 50 Ω Surface-mount terminal Min. 35 dB (3 GHz) 75 Ω PC board terminal	Max. 0.5 dB (3 GHz) 50 Ω Surface-mount terminal Max. 0.35 dB (3 GHz) 75 Ω PC board terminal

■ Terminal socket

SP, NC, HE, SFS

■ Socket

S, ST, NC, PA-N, DK, DS-P, JW, SFS

■ LED operation indication type

SFS

SAFETY STANDARDS Each standard may be updated at any time, so please check our Website for the latest information.

<https://www3.panasonic.biz/ac/e/service/export/information/standards/relay/index.jsp?c=search>

Please refer to "the latest product specifications" when designing your product.

- Requests to customers:
<https://industrial.panasonic.com/ac/e/salespolicies/>

■Global Sales Network Information: industrial.panasonic.com/ac/e/salesnetwork

Panasonic
INDUSTRY

Panasonic Industry Co., Ltd.

Electromechanical Control Business Division
■1006, Oaza Kadoma, Kadoma-shi, Osaka 571-8506, Japan
industrial.panasonic.com/ac/e/