

 Not Recommended for New Design
Effective date: October 1, 2024

PhotoIC Coupler (AlGaAs LED & PhotoIC) 20 Mbps type

Product Catalog

**IN Your
Future**

20 Mbps type

! Not Recommended for New Design
Effective date: October 1, 2024

Low input voltage and low power consumption achieved. High speed Photo Coupler with receiver circuit IC.

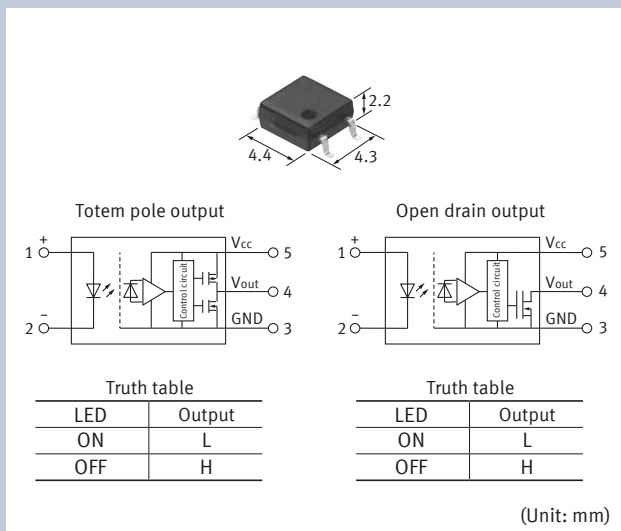

FEATURES

- Capable of high speed communication (Transfer rate Typ. 20 Mbps)
- Low power consumption: LED forward current: 6 to 12 mA, Supply current: Max. 3 mA
- High noise immunity (CMTI Min. 20 kV/μs)
- Guaranteed performance at high temperature (-40 to +105 °C)
- Isolation voltage: 3,750 Vrms
- Totem pole and Open drain output types available

TYPICAL APPLICATIONS

- Measuring equipment
- FA (Factory Automation) network
- I/O of high speed communication
- Microcomputer communication (SPI, I²C)
- Data communication equipment

Note) This product is not for automotive use.
Please contact our sales representative for automotive applications.

TYPES

Figure of output	Transfer rate	Supply voltage	Part No.		Packing quantity	
			Tube packing style	Tape and reel packing style X*	Tube	Tape and reel
Totem pole output	Typ. 20 Mbps	3 to 5 V DC	APS1241S	APS1241SX	1-tube : 100 pcs. Outer carton: 2,000 pcs.	1-reel : 1,000 pcs. Outer carton: 1,000 pcs.
Open drain output			APS2241S	APS2241SX		

* Tape and reel packing style X: picked from the 1/2-pin side. For part numbers with picked from the 3/4/5-pin side, change the " X " at the end to " Z " when ordering.

RATING

Totem pole output

Absolute maximum ratings (Ambient temperature: 25 °C)

Item		Symbol	APS1241S	Remarks
Input	LED forward current	I_F	25 mA	
	LED reverse voltage	V_R	5 V	
	Peak forward current	I_{FP}	1 A	f = 100 Hz, Duty Ratio = 0.1 %, 1 shot
Output	Supply voltage	V_{CC}	6 V	
	Output voltage	V_O	6 V	
	Output current	I_O	10 mA	
	Power dissipation	P_{out}	40 mW	
I/O isolation voltage		V_{iso}	3,750 Vrms	
Ambient temperature (Operating)		T_{opr}	-40 to +105 °C	(Avoid icing and condensation)
Ambient temperature (Storage)		T_{stg}	-40 to +125 °C	
Junction temperature		T_j	125 °C	

Electrical characteristics (Unless otherwise specified, $T_a = -40$ to $+105$ °C, $V_{CC} = 2.7$ to 5.5 V)

Item			Symbol	APS1241S	Condition
Input	Threshold input current	Maximum	I_{FHL}	4 mA	$V_{CC} = 5$ V $V_O < 0.4$ V
	LED dropout voltage	Minimum	V_F	1.45 V	$I_F = 10$ mA $T_a = 25$ °C
		Typical		1.6 V	
		Maximum		1.8 V	
Input capacitance	Typical	C_t	20 pF	f = 1 MHz $V_B = 0$ V $T_a = 25$ °C	
Output	Low level supply current	Maximum	I_{CCL}	3 mA	$I_F = 9$ mA
	High level supply current	Maximum	I_{CCH}	3 mA	$I_F = 0$ mA
	Low level output voltage	Maximum	V_{OL}	0.4 V	$I_F = 9$ mA $I_O = 4$ mA $V_{CC} = 5$ V
	High level output voltage	Minimum	V_{OH}	4 V	$I_F = 0$ mA $I_O = -4$ mA $V_{CC} = 5$ V

Item			Symbol	APS1241S	Condition
Transfer characteristics	Propagation delay time (H → L)	Maximum	t_{pHL}	55 ns	$V_{IN} = 0 \rightarrow 2.5$ V, $R_{IN} = 100$ Ω $C_{IN} = 15$ pF, $C_O = 15$ pF
	Propagation delay time (L → H)	Maximum	t_{pLH}	55 ns	$V_{IN} = 2.5 \rightarrow 0$ V, $R_{IN} = 100$ Ω $C_{IN} = 15$ pF, $C_O = 15$ pF
	Propagation delay skew	Maximum	t_{psk}	30 ns	—
	Pulse width distortion	Maximum	$ t_{pHL} - t_{pLH} $	30 ns	$V_{IN} = 2.5$ V/10 MHz, $R_{IN} = 100$ Ω $C_{IN} = 15$ pF, $C_O = 15$ pF
	Output fall time	Typical	t_f	2 ns	$V_{IN} = 0 \rightarrow 2.5$ V, $R_{IN} = 100$ Ω $C_{IN} = 15$ pF, $C_O = 15$ pF
	Output rise time	Typical	t_r	2 ns	$V_{IN} = 2.5 \rightarrow 0$ V, $R_{IN} = 100$ Ω $C_{IN} = 15$ pF, $C_O = 15$ pF
	Common mode transient immunity at low level output	Minimum	CM_L	20 kV/μs	$V_{CM} = 1000$ V _{pp} , $I_F = 9$ mA $V_{CC} = 5$ V, $V_{O(MIN)} = 0.4$ V $T_a = 25$ °C
	Common mode transient immunity at high level output	Minimum	CM_H	20 kV/μs	$V_{CM} = 1000$ V _{pp} , $I_F = 0$ mA $V_{CC} = 5$ V, $V_{O(MIN)} = 4$ V $T_a = 25$ °C
	I/O capacitance	Typical	C_{iso}	0.5 pF	f = 1 MHz, $V_B = 0$ V $T_a = 25$ °C
Initial I/O isolation resistance	Minimum	R_{iso}	1,000 MΩ	500 V DC, RH ≤ 60 % $T_a = 25$ °C	

● Test circuit for I_{CCL}

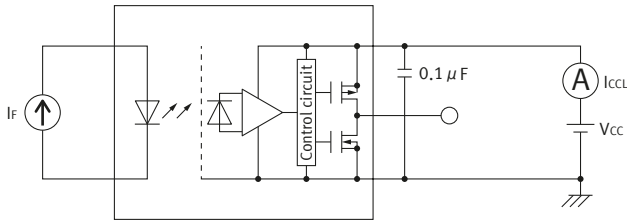

● Test circuit for I_{CCH}

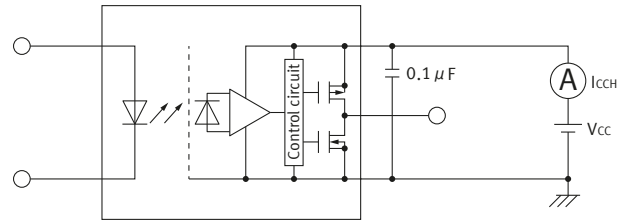

● Test circuit for V_{OL}

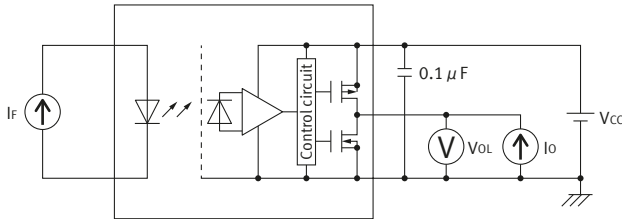

● Test circuit for V_{OH}

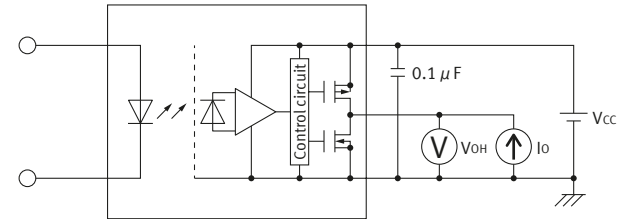

● Test circuit for propagation delay time

$V_{IN} = 0 \leftrightarrow 2.5 V$
 $f = 10 MHz$
Duty factor = 50 %

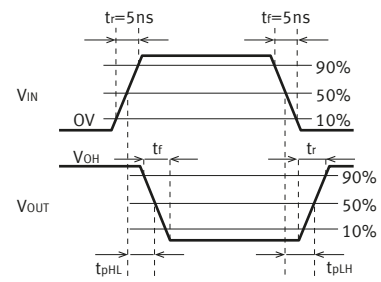
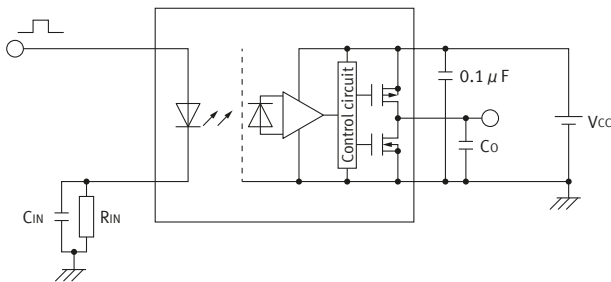

● Test circuit for common mode transient immunity

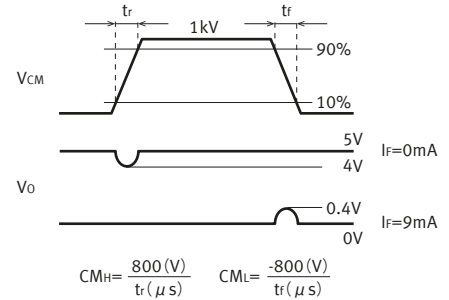
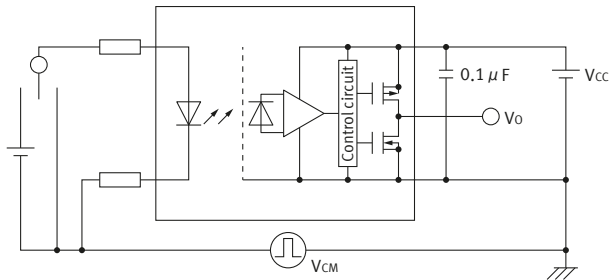

■ Recommended operating conditions

Please use under recommended operating conditions to obtain expected characteristics.

Item	Symbol	Min.	Max.	Unit
LED forward current	I_F	6	12	mA
Supply voltage	V_{CC}	2.7	5.5	V
LED off voltage	$V_{F(OFF)}$	0	0.8	V

REFERENCE DATA

Totem pole output

1. LED forward current vs. ambient temperature characteristics

Permissible ambient temperature: -40 to +105 °C

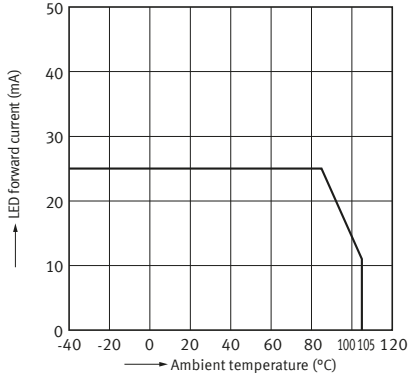

2. LED forward current vs. LED drop out voltage characteristics

Permissible ambient temperature: -40 to +105 °C

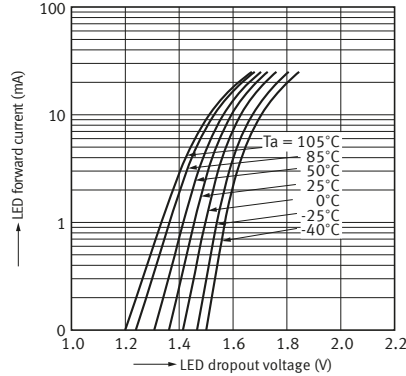

3. Threshold input current vs. ambient temperature characteristics

Supply voltage: 5 V
Output voltage: < 0.4 V

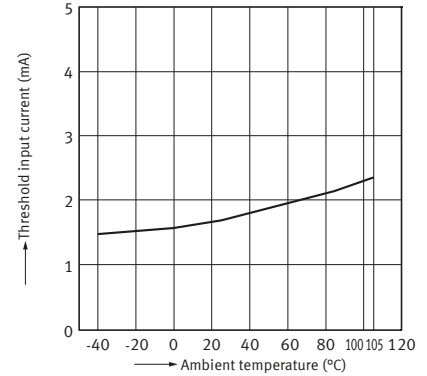

4. Low level/high level supply current vs. ambient temperature characteristics

Supply voltage: 5 V

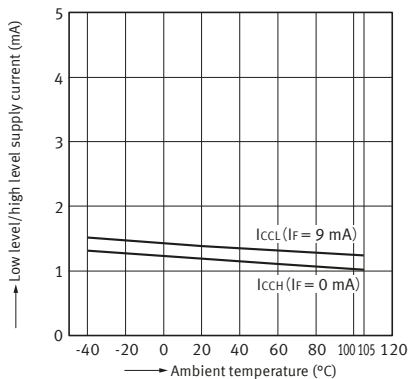

5. Low level output voltage vs. ambient temperature characteristics

Supply voltage: 5 V; LED current: 9 mA
Output current: 4 mA

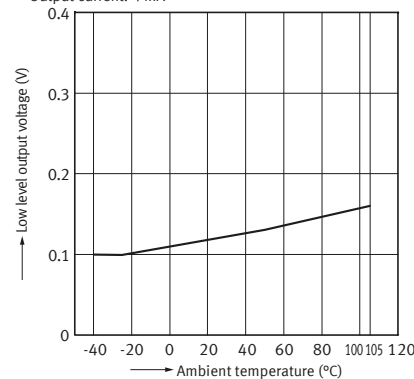

6. High level output voltage vs. ambient temperature characteristics

Supply voltage: 5 V; LED current: 0 mA
Output current: -4 mA

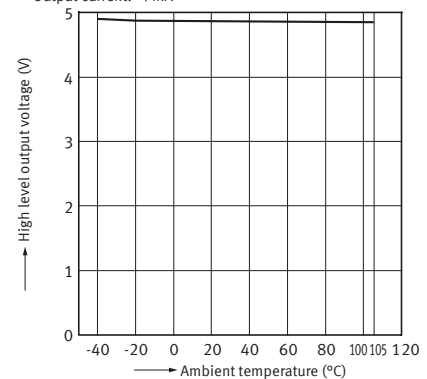

7. Propagation delay time (H → L/L → H) vs. ambient temperature characteristics

Supply voltage: 5 V
LED current: 9 mA

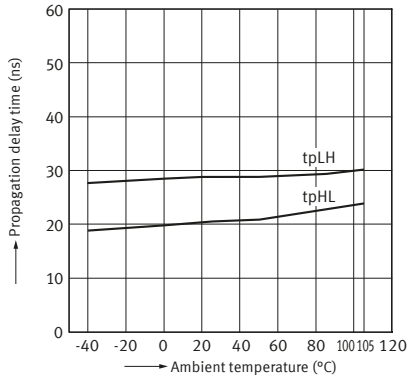

8. Pulse width distortion vs. ambient temperature characteristics

Supply voltage: 5 V
LED current: 9 mA

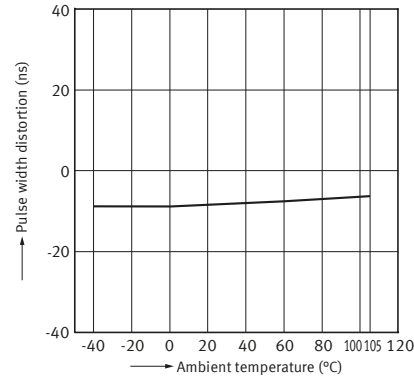

9. Propagation delay time (H → L/L → H) vs. LED forward current characteristics

Supply voltage: 5 V
Ambient temperature: 25 °C

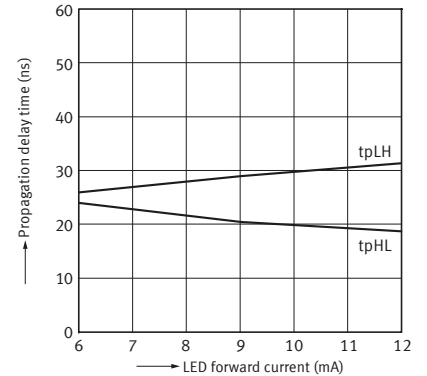

10. Pulse width distortion vs. LED forward current characteristics

Supply voltage: 5 V
Ambient temperature: 25 °C

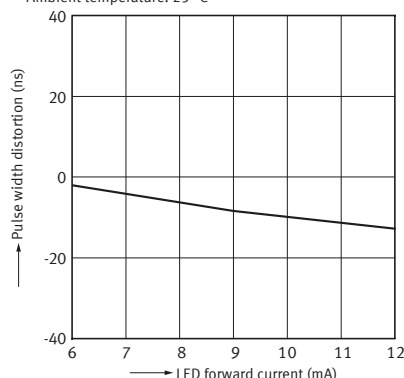

RATING

Open drain output

Absolute maximum ratings (Ambient temperature: 25 °C)

Item		Symbol	APS2241S	Remarks
Input	LED forward current	I_F	25 mA	
	LED reverse voltage	V_R	5 V	
	Peak forward current	I_{FP}	1 A	f = 100 Hz, Duty Ratio = 0.1 %, 1 shot
Output	Supply voltage	V_{CC}	6 V	
	Output voltage	V_O	6 V	
	Output current	I_O	25 mA	
	Power dissipation	P_{out}	40 mW	
I/O isolation voltage		V_{iso}	3,750 Vrms	
Ambient temperature (Operating)		T_{opr}	-40 to +105 °C	(Avoid icing and condensation)
Ambient temperature (Storage)		T_{stg}	-40 to +125 °C	
Junction temperature		T_j	125 °C	

Electrical characteristics (Unless otherwise specified, $T_a = -40$ to $+105$ °C, $V_{CC} = 2.7$ to 5.5 V)

Item			Symbol	APS2241S	Condition
Input	Threshold input current	Maximum	I_{FHL}	4 mA	$V_{CC} = 5$ V $V_O < 0.6$ V
		Minimum		1.45 V	$I_F = 10$ mA $T_a = 25$ °C
	Typical	V_F	1.6 V		
	Maximum		1.8 V		
Input capacitance	Typical	C_t	20 pF	f = 1 MHz $V_B = 0$ V $T_a = 25$ °C	
Output	Low level supply current	Maximum	I_{CCL}	3 mA	$I_F = 9$ mA
	High level supply current	Maximum	I_{CCH}	3 mA	$I_F = 0$ mA
	Low level output voltage	Maximum	V_{OL}	0.6 V	$I_F = 9$ mA $I_O = 13$ mA $V_{CC} = 5$ V
	High level output current	Minimum	I_{OH}	50 μA	$I_F = 0$ mA $V_{CC} = 5.5$ V $V_O = 5.5$ V

Item	Symbol	AP52241S	Condition
Propagation delay time (H → L)	Maximum	t_{pHL}	60 ns $V_{IN} = 0 \rightarrow 2.5 \text{ V}$, $R_{IN} = 100 \Omega$ $C_{IN} = 15 \text{ pF}$, $R_O = 360 \Omega$ $C_O = 15 \text{ pF}$
Propagation delay time (L → H)	Maximum	t_{pLH}	60 ns $V_{IN} = 2.5 \rightarrow 0 \text{ V}$, $R_{IN} = 100 \Omega$ $C_{IN} = 15 \text{ pF}$, $R_O = 360 \Omega$ $C_O = 15 \text{ pF}$
Propagation delay skew	Maximum	t_{psk}	40 ns —
Pulse width distortion	Maximum	$ t_{pHL} - t_{pLH} $	35 ns $V_{IN} = 2.5 \text{ V}/5 \text{ MHz}$, $R_{IN} = 100 \Omega$ $C_{IN} = 15 \text{ pF}$, $R_O = 360 \Omega$ $C_O = 15 \text{ pF}$
Output fall time	Typical	t_f	1 ns $V_{IN} = 0 \rightarrow 2.5 \text{ V}$, $R_{IN} = 100 \Omega$ $C_{IN} = 15 \text{ pF}$, $R_O = 360 \Omega$ $C_O = 15 \text{ pF}$
Output rise time	Typical	t_r	18 ns $V_{IN} = 2.5 \rightarrow 0 \text{ V}$, $R_{IN} = 100 \Omega$ $C_{IN} = 15 \text{ pF}$, $R_O = 360 \Omega$ $C_O = 15 \text{ pF}$
Common mode transient immunity at low level output	Minimum	CM_L	20 kV/ μ s $V_{CM} = 1000 \text{ V}_{pp}$, $I_f = 9 \text{ mA}$ $V_{CC} = 5 \text{ V}$, $V_{O(MAX)} = 0.8 \text{ V}$ $T_a = 25 \text{ }^\circ\text{C}$
Common mode transient immunity at high level output	Minimum	CM_H	20 kV/ μ s $V_{CM} = 1000 \text{ V}_{pp}$, $I_f = 0 \text{ mA}$ $V_{CC} = 5 \text{ V}$, $V_{O(MIN)} = 2 \text{ V}$ $T_a = 25 \text{ }^\circ\text{C}$
I/O capacitance	Typical	C_{iso}	0.5 pF $f = 1 \text{ MHz}$, $V_B = 0 \text{ V}$ $T_a = 25 \text{ }^\circ\text{C}$
Initial I/O isolation resistance	Minimum	R_{iso}	1,000 M Ω 500 V DC, RH \leq 60 % $T_a = 25 \text{ }^\circ\text{C}$

● Test circuit for I_{cCL}

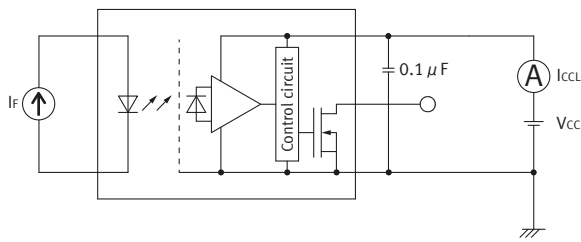

● Test circuit for I_{cCH}

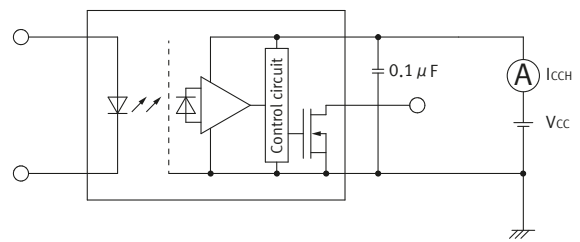

● Test circuit for V_{OL}

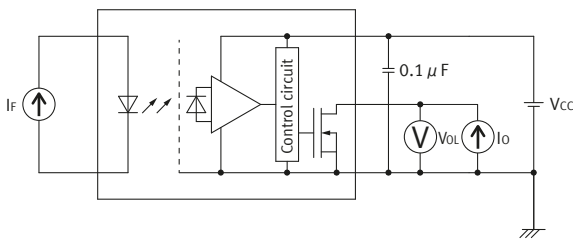

● Test circuit for I_{OH}

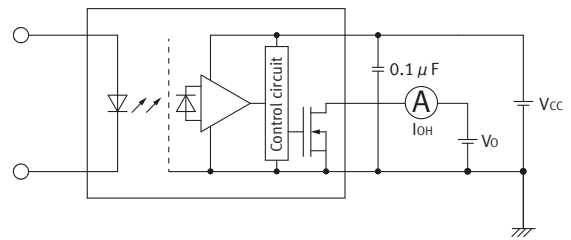

● Test circuit for propagation delay time

$V_{IN} = 0 \leftrightarrow 2.5\text{ V}$
 $f = 5\text{ MHz}$
Duty factor = 50 %

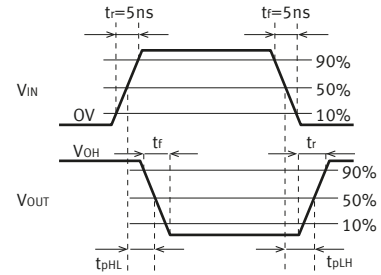
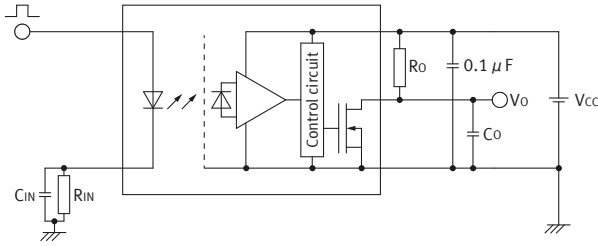

● Test circuit for common mode transient immunity

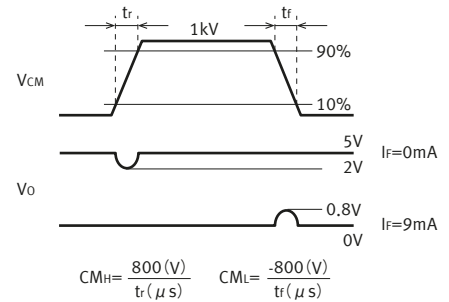
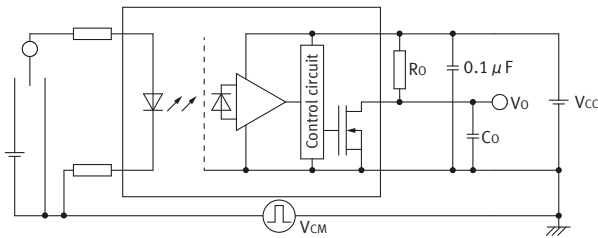

■ Recommended operating conditions

Please use under recommended operating conditions to obtain expected characteristics.

Item	Symbol	Min.	Max.	Unit
LED forward current	I_F	6	12	mA
Supply voltage	V_{CC}	2.7	5.5	V
LED off voltage	$V_{F(OFF)}$	0	0.8	V

REFERENCE DATA

Open drain output

1. LED forward current vs. ambient temperature characteristics

Permissible ambient temperature: -40 to $+105\text{ }^\circ\text{C}$

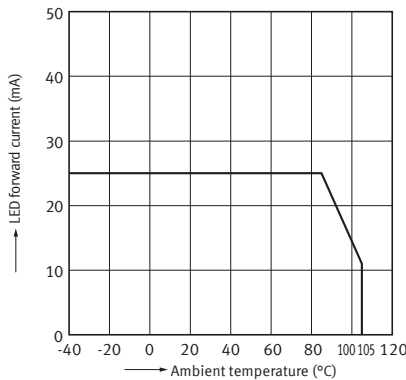

2. LED forward current vs. LED drop out voltage characteristics

Permissible ambient temperature: -40 to $+105\text{ }^\circ\text{C}$

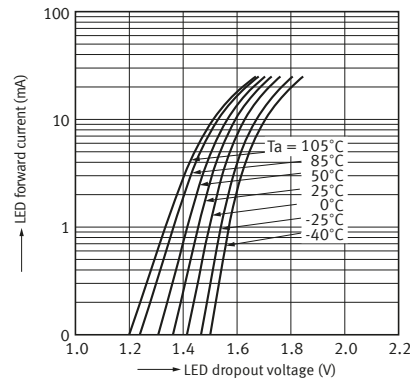

3. Threshold input current vs. ambient temperature characteristics

Supply voltage: 5 V
Output voltage: $< 0.6\text{ V}$

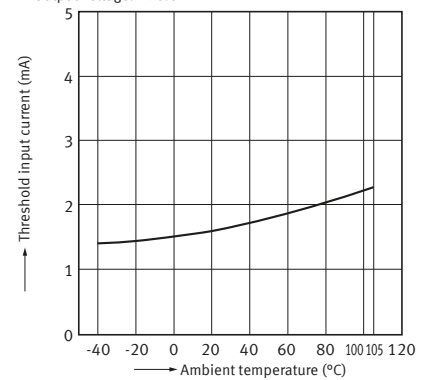

4. Low level/high level supply current vs. ambient temperature characteristics

Supply voltage: 5 V

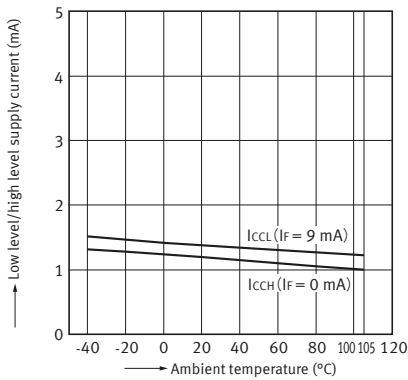

5. Low level output voltage vs. ambient temperature characteristics

Supply voltage: 5 V; LED current: 9 mA
Output current: 13 mA

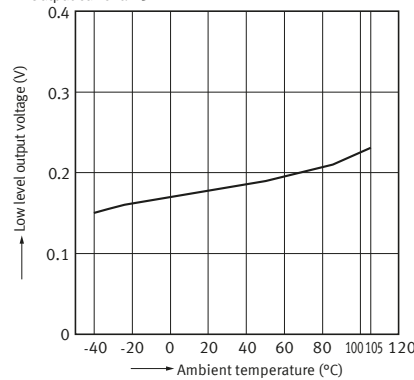

6. Propagation delay time (H → L/L → H) vs. ambient temperature characteristics

Supply voltage: 5 V
LED current: 9 mA

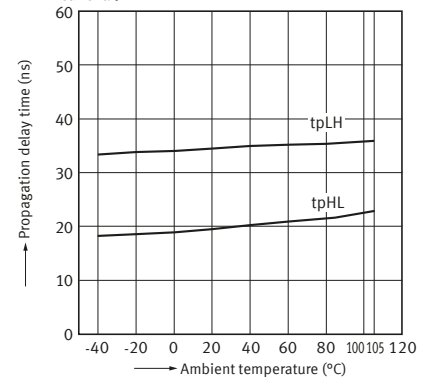

7. Pulse width distortion vs. ambient temperature characteristics

Supply voltage: 5 V
LED current: 9 mA

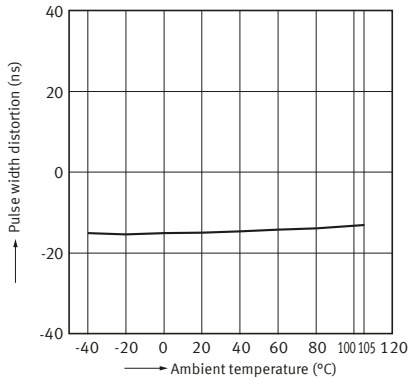

8. Propagation delay time (H → L/L → H) vs. LED forward current characteristics

Supply voltage: 5 V
Ambient temperature: 25 °C

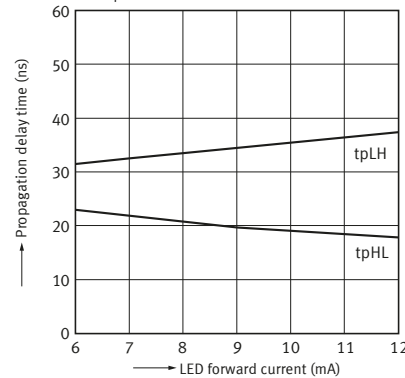

9. Pulse width distortion vs. LED forward current characteristics

Supply voltage: 5 V
Ambient temperature: 25 °C

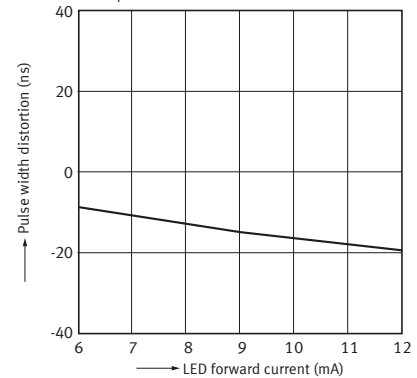

DIMENSIONS (Unit: mm)

CAD The CAD data of the products with a " CAD " mark can be downloaded from our Website.

CAD



External dimensions

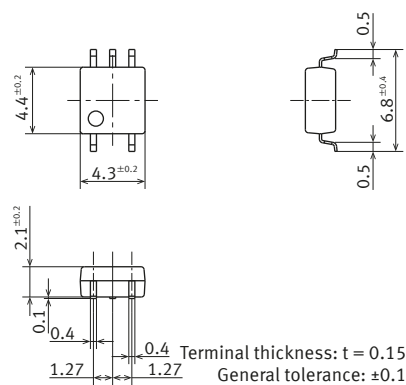

Recommended mounting pad (TOP VIEW)

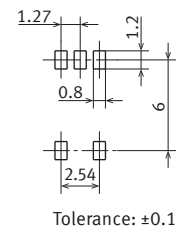

SAFETY STANDARDS

Each standard may be updated at any time, so please check our Website for the latest information.

Part No.		UL (Recognized)		CSA (Certified)	
		File No. (Standard No.)	Contact rating	File No. (Standard No.)	Contact rating
PhotoIC Coupler	20 Mbps	APS1241S	—	E191218 (UL1577)	(Certified by C-UL)
		APS2241S			

CAUTIONS FOR USE

■ For cautions for use, please read " CAUTIONS FOR USE OF PHOTOIC COUPLERS " .

■ Cautions for use PhotoIC Coupler 20 Mbps type**● Pull up resistor (Open drain output type)**

Please connect pull up resistor between Vo and Vcc. The pull up resistor affects the coupler transfer characteristics. Therefore, please evaluate the coupler under the actual condition.

● Ripple in the input power supply

If ripple is present in the input power supply, please keep the LED forward current from 6 (at Emin) to 12 mA (at Emax) .

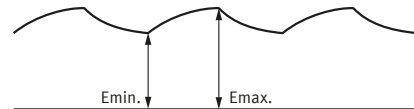

Please refer to " **the latest product specifications** " when designing your product.

• Requests to customers:

<https://industry.panasonic.com/global/en/salespolicies>

Cautions for Use of PhotoIC Couplers

⚠ SAFETY WARNINGS

- Do not use the product under conditions that exceed the range of its specifications. It may cause overheating, smoke, or fire.
- Do not touch the recharging unit while the power is on. There is a danger of electrical shock. Be sure to turn off the power when performing mounting, maintenance, or repair operations on the device (including connecting parts such as the terminal board and socket).
- Check the connection diagrams in the catalog and be sure to connect the terminals correctly. Erroneous connections could lead to unexpected operating errors, overheating, or fire.

■ Please visit our Automation Controls Products web site and refer to the caution for use and the explanations of technical terms.

■ About derating design

Derating is significant factor concerning on reliable design (product life). When the coupler is used continuously at upper limit of absolute maximum ratings (high temperature, high humidity, high current, high voltage, etc.), reliability may be lower significantly. Therefore, please derate sufficiently below the absolute maximum ratings and evaluate the coupler under the actual condition.

■ Wire connection

Please check the internal connection diagram in the catalog or specification, and connect the terminals correctly. If device is energized with short-circuit or any wrong connection, it may cause circuit damage by inner parts destruction, unexpected malfunction, abnormal heat, fire, and so on.

■ Bypass capacitor

Bypass capacitor of 0.1 μF is used between Vcc and GND near the coupler. Also, ensure that the distance between the leads of the coupler and capacitor is no more than 10 mm. Failure to provide the bypass may impair the switching property.

■ Deterioration and destruction caused by discharge of static electricity

This phenomenon is generally called static electricity destruction, and occurs when static electricity generated by various factors is discharged while the coupler terminals are in contact, producing internal destruction of the element. To prevent problems from static electricity, the following precautions and measures should be taken when using your device.

- 1) Employees handling the coupler should wear anti-static clothing and should be grounded through protective resistance of 500 k Ω to 1 M Ω .
- 2) A conductive metal sheet should be placed over the worktable. Measuring instruments and jigs should be grounded.
- 3) When using soldering irons, either use irons with low leakage current, or ground the tip of the soldering iron. (Use of low-voltage soldering irons is also recommended.)
- 4) Devices and equipment used in assembly should also be grounded.
- 5) When packing printed circuit boards and equipment, avoid using high-polymer materials such as foam styrene, plastic, and other materials which carry an electrostatic charge.
- 6) When storing or transporting the coupler, the environment should not be conducive to generating static electricity (for instance, the humidity should be between 45 and 60 %), and the coupler should be protected using conductive packing materials.

■ Caution for applying supply voltage

Just after supplying voltage, please note that current in the coupler will be not constant until circuit stability.

Cautions for Use of PhotoIC couplers

■ Soldering

① IR (Infrared reflow) soldering method

In case of automatic soldering, following conditions should be observed.

(recommended condition reflow: Max. 2 times, measurement point: soldering lead)

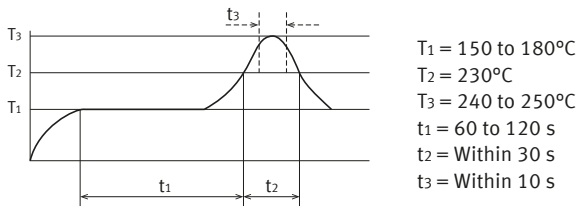

② Others soldering methods

Other soldering methods (VPS, hot-air, hot plate, laser heating, pulse heater, etc.) affect the coupler characteristics differently, please evaluate the coupler under the actual usage.

③ Manual soldering method

Soldering: Max. 350°C , within 3 s,
electrical power 30 to 60 W

■ Notes for mounting

1) When different kinds of packages are mounted on PC board, the temperature rise at soldering lead is highly dependent on package size. Therefore, please set the lower temperature soldering condition than above condition, and confirm the temperature condition of actual usage before soldering.

2) When soldering condition is out of recommendation, the coupler characteristics may be adversely affected. It may occur package crack or bonding wire breaking because of thermal expansion unconformity and resin strength reduction. Please contact us about the propriety of the condition.

3) Please confirm the heat stress by using actual board because it may be changed by board condition or manufacturing process condition.

4) Solder creepage, wettability, or soldering strength will be affected by the soldering condition or used solder type. Please check them under the actual production condition in detail.

5) Please apply coating when the coupler returns to the room temperature.

■ Cleaning solvents compatibility

Cleaning the solder flux should use the immersion washing with a cleaning solvent (Asahiklin AK-225). If you have to use ultrasonic cleaning, please adopt the following conditions and check that there are no problems in the actual usage.

- Frequency : 27 to 29 kHz
- Ultrasonic output: No greater than 0.25 W/cm^2 *
- Cleaning time : 30 s or less
- Others : Float PC board and the device in cleaning solvent to prevent from contacting the ultrasonic vibrator.

* Applies to unit area of ultrasonic output for ultrasonic baths.

■ Transportation and storage

1) Extreme vibration during transport may deform the lead or damage the coupler. Please handle the outer and inner boxes with care.

2) Inadequate storage condition may degrade soldering, appearance and characteristics.

The following storage conditions are recommended:

- Temperature: 0 to 45°C
- Humidity : Max. 70 % RH
- Atmosphere : No harmful gasses such as sulfurous acid gas and not dusty.

3) In case the heat stress of soldering is applied to the coupler which absorb moisture inside of its package, the evaporation of the moisture increases the pressure inside the package and it may cause the package blister or crack. This coupler is sensitive to moisture and it is packed in the sealed moisture-proof package. Please make sure the following condition after unsealing.

*Please use the coupler immediately after unsealing.
(within 30 days at 0 to 30°C and Max. 70% RH)

*If the coupler will be kept for a long time after unsealing, please pack in the another moisture-proof package containing silica gel and store. (Please use within 90 days)

■ Water condensation

Water condensation occurs when the ambient temperature changes suddenly from a high temperature to low temperature at high humidity, or the coupler is suddenly transferred from a low ambient temperature to a high temperature and humidity.

Condensation causes the failures such as insulation deterioration. Panasonic Industry does not guarantee the failures caused by water condensation.

The heat conduction by the equipment the coupler is mounted may accelerate inside equipment water condensation. Please confirm no that there are condensation in the worst condition of the actual usage.

(Special attention should be paid when high temperature heating parts are close to the coupler.)

Cautions for Use of PhotoIC couplers

■ Coupler packaging format

1) Tape and reel

Unit: mm

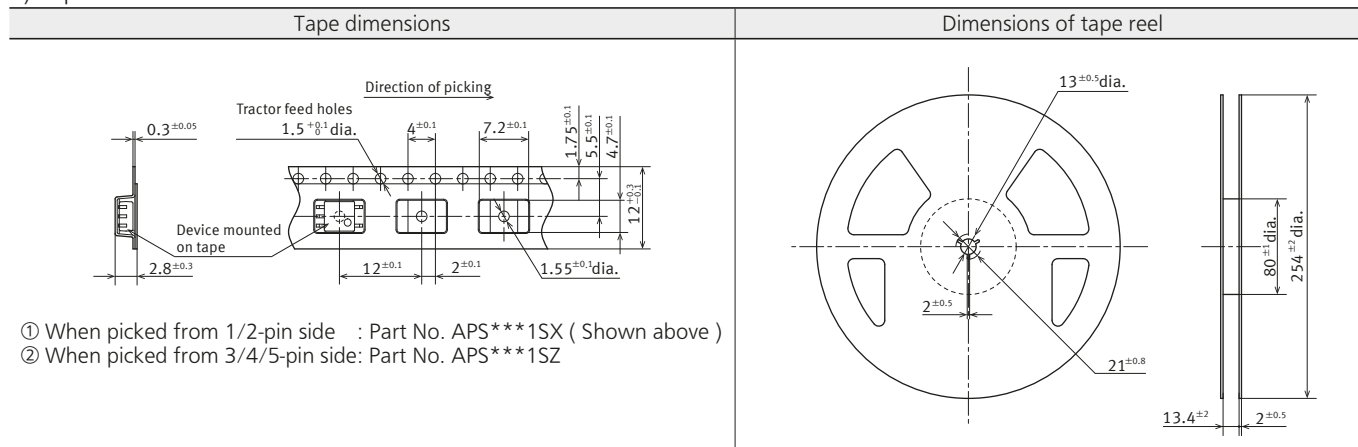

Please refer to " the latest product specifications " when designing your product.

- Requests to customers:
<https://industry.panasonic.com/global/en/salespolicies>

■ Global Sales Network Information: industry.panasonic.com/global/en/salesnetwork/globalnetwork

Panasonic
INDUSTRY

Panasonic Industry Co., Ltd.

Electromechanical Control Business Division

■ 1006, Oaza Kadoma, Kadoma-shi, Osaka 571-8506, Japan
industry.panasonic.com