

Products Catalog

**Conductive Polymer Hybrid Aluminum  
Electrolytic Capacitors**  
**Hybrid**

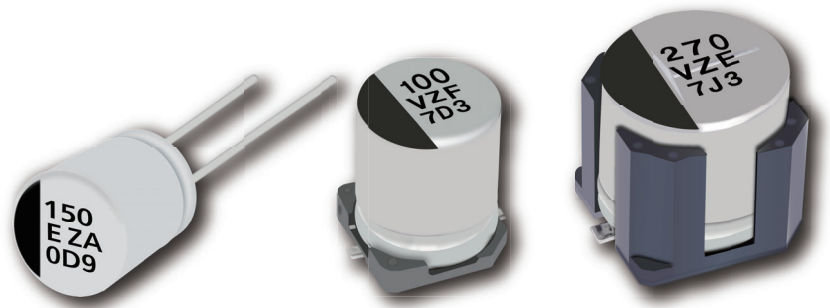

**IN Your  
Future**



## Conductive Polymer Hybrid Aluminum Electrolytic Capacitors INDEX

Item		Page
<a href="#">Safety and Legal Matters to Be Observed / Matters to Be Observed When Using This Product</a>		1
Selection guide	<a href="#">Line-up</a>	8
	<a href="#">Series flow chart</a>	10
	<a href="#">Voltage - Capacitance table</a>	11
	<a href="#">Explanation of part numbers</a>	15
	<a href="#">Recommended reflow soldering / Mounting specifications</a>	16
	<a href="#">Packing specifications</a>	18
Surface mount type	<a href="#">ZA series</a> : 105 °C 10000 h	19
	<a href="#">ZC series</a> : 125 °C 4000 h	21
	<a href="#">ZK series</a> : 125 °C 4000 h	23
	<a href="#">ZKU series</a> : 125 °C 4000 h	25
	<a href="#">ZL series</a> : 135 °C 4000 h	27
	<a href="#">ZT series</a> : 125 °C 4000 h	29
	<a href="#">ZTU series</a> : 135 °C 4000 h	31
	<a href="#">ZV series</a> : 135 °C 4000 h	33
	<a href="#">ZS series</a> : 135 °C 4000 h	35
	<a href="#">ZSU series</a> : 125 °C 4000 h	37
	<a href="#">ZU series</a> : 135 °C 4000 h	39
	<a href="#">ZUU series</a> : 135 °C 4000 h	41
	<a href="#">ZE series</a> : 145 °C 2000 h	43
	<a href="#">ZF series</a> : 150 °C 1000 h	45
Radial lead type	<a href="#">ZA-A series</a> : 105 °C 10000 h	47
	<a href="#">ZC-A series</a> : 125 °C 4000 h	49
	<a href="#">ZK-A series</a> : 125 °C 4000 h	51
	<a href="#">ZKU-A series</a> : 125 °C 4000 h	53
	<a href="#">ZT-A series</a> : 125 °C 4000 h	55
	<a href="#">ZS-A series</a> : 135 °C 4000 h	57
	<a href="#">ZSU-A series</a> : 125 °C 4000 h	59
	<a href="#">ZE-A series</a> : 145 °C 2000 h	61
<a href="#">ZF-A series</a> : 150 °C 1000 h	63	

## Safety and Legal Matters to Be Observed

### Product specifications and applications

- Please be advised that this product and product specifications are subject to change without notice for improvement purposes. Therefore, please request and confirm the latest delivery specifications that explain the specifications in detail before the final design, or purchase or use of the product, regardless of the application. In addition, do not use this product in any way that deviates from the contents of the company's delivery specifications.
- Unless otherwise specified in this catalog or the product specifications, this product is intended for use in general electronic equipment (AV products, home appliances, commercial equipment, office equipment, information and communication equipment, etc.).  
When this product is used for the following special cases, the specification document suited to each application shall be signed/sealed (with Panasonic Industry and the user) in advance..These include applications requiring special quality and reliability, wherein their failures or malfunctions may directly threaten human life or cause harm to the human body (e.g.: space/aircraft equipment, transportation/traffic equipment, combustion equipment, medical equipment, disaster prevention/crime prevention equipment, safety equipment, etc.).

### Safety design and product evaluation

- Please ensure safety through protection circuits, redundant circuits, etc., in the customer's system design so that a defect in our company's product will not endanger human life or cause other serious damage.
- This catalog shows the quality and performance of individual parts. The durability of parts varies depending on the usage environment and conditions. Therefore, please ensure to evaluate and confirm the state of each part after it has been mounted in your product in the actual operating environment before use.  
If you have any doubts about the safety of this product, then please notify us immediately, and be sure to conduct a technical review including the above protection circuits and redundant circuits at your company.

### Laws / Regulations / Intellectual property

- The transportation of dangerous goods as designated by UN numbers, UN classifications, etc., does not apply to this product. In addition, when exporting products, product specifications, and technical information described in this catalog, please comply with the laws and regulations of the countries to which the products are exported, especially those concerning security export control.
- Each model of this product complies with the RoHS Directive (Restriction of the use of hazardous substances in electrical and electronic equipment) (2011/65/EU and (EU) 2015/863). The date of compliance with the RoHS Directive and REACH Regulation varies depending on the product model.  
Further, if you are using product models in stock and are not sure whether or not they comply with the RoHS Directive or REACH Regulation, please contact us by selecting "Sales Inquiry" from the inquiry form.
- During the manufacturing process of this product and any of its components and materials to be used, Panasonic Industry does not intentionally use ozone-depleting substances stipulated in the Montreal Protocol and specific bromine-based flame retardants such as PBBs (Poly-Brominated Biphenyls) / PBDEs (Poly-Brominated Diphenyl Ethers). In addition, the materials used in this product are all listed as existing chemical substances based on the Act on the Regulation of Manufacture and Evaluation of Chemical Substances.
- With regard to the disposal of this product, please confirm the disposal method in each country and region where it is incorporated into your company's product and used.
- The technical information contained in this catalog is intended to show only typical operation and application circuit examples of this product. This catalog does not guarantee that such information does not infringe upon the intellectual property rights of Panasonic Industry or any third party, nor imply that the license of such rights has been granted.
- Design, materials, or process related to technical owned by Panasonic Industry are subject to change without notice.

**Panasonic Industry will assume no liability whatsoever if the use of our company's products deviates from the contents of this catalog or does not comply with the precautions. Please be advised of these restrictions.**

**Matters to Be Observed When Using This Product**

(Conductive polymer hybrid aluminum electrolytic capacitor / Aluminum electrolytic capacitor)

**Use environments and cleaning conditions**

- This product (capacitor) is intended for standard general-purpose use in electronic equipment, and is not designed for use in the specific environments described below. Using the product in such specific environments or service conditions, therefore, may affect the performance of the product.  
Check with us about the performance and reliability of the product first before using the product.
  - (1) Used at a temperature higher than the upper limit category temperature or lower than the lower limit category temperature.
  - (2) Used in an environment where the product is directly exposed to water, salt water, oil, etc., or in a liquid, such as water, oil, chemicals, and organic solvents.
  - (3) Used in an outdoor environment where the product is exposed to direct sunlight, ozone, radiation, UV-rays, etc., or in a dusty place.
  - (4) Used in a wet place (dew concentration on a resistor, water leakage, etc.), a place exposed to sea breeze, or a place filled with a corrosive gas, such as Cl<sub>2</sub>, H<sub>2</sub>S, NH<sub>3</sub>, SO<sub>2</sub>, or NO<sub>x</sub>.
  - (5) Used in an environment filled with a toxic gas (hydrogen sulfide, sulfurous acid, nitrous acid, chlorine and chlorine compound, bromine and bromine compound, ammonia, etc.)
  - (6) Used in an environment where static electricity and electromagnetic waves are strong.
  - (7) Located close to heating component or a flammable material, such as a vinyl cable.
  - (8) Sealed with a resin, etc.
  - (9) Cleansed with a solvent, water, or a water-soluble cleaner, to remove solder flux after soldering.
  - (10) Used in an environment where an acidic or alkali atmosphere is present.
  - (11) Used in an environment where excessive vibration or mechanical shocks exceeding a specified range is applied to the product (even if the applied vibration or mechanical shocks is within the specified range, it may cause the product to resonate, in which a large vibration acceleration may be generated. Make sure to evaluate/check such vibrations or impacts applied to the product in an actual service condition).
  - (12) Used under a low atmospheric pressure condition or depressurized condition.
- The capacitor withstands an immersion cleaning process where the board carrying the product is immersed in a cleaning solution of 60 °C or lower for less than 5 minutes and withstands an ultrasonic cleaning process as well. However, ensure to thoroughly rinse and dry it. Some cleaning methods erase or blur notes on the capacitor in some cases. Some types of capacitors are not washable and some cleaning solutions cannot be used to clean a capacitor. If you are not sure about which type of capacitor is not washable or which cleaning solution cannot be used, please contact us. Solvents you can use to clean the board are as follows.

Pine Alpha ST-100S, Aqua Cleaner 210SEP, Cleanthrough 750H/750L/710M, Sun Elec B-12, Techno Cleaner 219, Cold Cleaner P3-375, DK Be clear CW-5790, Terpene Cleaner EC-7R, Techno Care FRW-17/FRW-1/FRV-1
- Keep the cleaning solution under strict contamination control (conductivity, pH, specific gravity, water content, etc.). A contaminated cleaning solution will show a high chlorine concentration, thereby corroding the interior of the capacitor in some cases. Keep the flux concentration in the cleaning solution at a 2% mass or less.
- Unless otherwise specified in the specifications, avoid cleaning the capacitor with a halogen-based solvent, an alkaline solvent, a petroleum-based solvent, xylene, or acetone. Using a halogen-based solvent may result in a case where the solvent infiltrates (leaks) into the capacitor and break-down releasing chlorine, which reacts with aluminum which can corrode the capacitor interior. 1-1-1 trichloroethane is particularly harmful to a capacitor. Never use it to clean a capacitor. A alkaline solvent may corrode (dissolve) an aluminum case, a petroleum-based solvent and xylene may damage the sealing rubber and accelerate its deterioration, and acetone may erase notes on the capacitor.  
To protect the global environment, refrain from using an ozone depleting substance as the cleaning solution.
- Right after the board cleaning, subject the capacitor to a forced drying process so that no cleaning solution remains between the sealing part of the capacitor and the printed board.  
Set a drying temperature equal to or lower than the upper limit category temperature.
- When an adhesive or coating agent is used to fix the capacitor and prevent dampening of the board, specific types of solvents included in some adhesives or coating agents may corrode the capacitor. Select a non-halogen solvent for the material making up the adhesive or coating agent. Do not use a chloroprene-based polymer.  
Solidify and dry the adhesive or coating agent sufficiently to prevent its solvent component from remaining on the capacitor. Leave at least 1/3 of the sealing part unsealed on the surface to which the adhesive or coating agent is applied.

- Do not use the product in a structure sealed by potting or molding. The pressure of a molding resin on a capacitor may deform the capacitor. In addition, the resin covering the capacitor may affect its heat dissipation performance or may leak into the product. These factors lead to the significant degradation of the capacitor's characteristics and reliability. There is also a concern that an electrolytic solution permeating the sealing rubber may agglomerate and cause a short circuit.
- When the capacitor is used in a circuit where an impact voltage is applied or a high voltage is applied in a short period (transient phenomenon) or a high pulse voltage is applied, make sure to use the capacitor at a voltage equal to or lower than its rated voltage.
- The product contains an electrolytic. Improper use of the capacitor leads not only to the rapid degradation of its characteristics but also to electrolytic leakage. These problems damage the circuit board and may lead to destruction of the entire circuit set.

## Response to anomalies and handling conditions

- When you see gas coming out of an activated pressure relief valve of a capacitor during use of a circuit set, turn off the main power supply of the circuit set or pull the power cord plug out of the wall-outlet. If you leave the power supply on and the capacitor short-circuits, it will damage the circuit, or the gas can turn into a liquid, which will cause the circuit to short. In the worst case scenarios, these events may develop into a more serious incident, such as burnout of the circuit set. The gas coming out of the pressure relief valve of a capacitor is not smoke, but is the electrolytic solution in its gaseous state.
- When the pressure valve of the capacitor is activated, it emits a high-temperature gas of over 100 °C. Do not bring your face near the valve. In case the gas jetting out of the valve gets in your eyes or comes into your mouth, wash your eyes with water or rinse your mouth immediately. If the gas hits your skin, wash it away with soap.
- If you touch a terminal of the product during use of the circuit set, you will get an electric shock. The aluminum case of the product has an exposed part with no insulation. Do not touch the exposed part because it is as dangerous as the terminal.
- Do not create a short circuit between terminals of the product by inserting a conductor therebetween. Do not splash a conductive solution, such as an acidic or alkali solution, on the capacitor. It puts the capacitor in a shorted state, which causes the circuit to fail and destroys the capacitor as well.
- When a silicone material containing a relatively large amount of a low-molecular-weight siloxane is located close to the product, it may cause the capacitor problems with its electrical performance.
- When electronic equipment having the capacitor built therein is exported to overseas markets, wooden packaging materials are fumigated with a halogen compound, such as methyl bromide. In such cases, if the packaging material subjected to the fumigation treatment is not dried sufficiently, halogen remaining on the packaging material may leach into the capacitor during transportation and trigger a corrosive reaction in the capacitor. When carrying out the fumigation treatment, carefully examine the dried packaging material to confirm that no halogen remains on the packaging material. Never fumigate the entire electronic equipment in its packaged state.

## Reliability and product life

- The product life is affected by temperatures. In general, a 10 °C drop in the temperature will double the life. Use the capacitor at a temperature as low as possible from the upper limit category temperature.
- Using a capacitor under a temperature condition outside a specified temperature range causes heavy degradation of the capacitor characteristics, which may result in breakage of the capacitor. You need to confirm not only the ambient temperature and internal temperature of the capacitor but also the temperature of the capacitor's top surface, which is given by radiant heat from built-in heating elements (a power transistor, IC, resistance, etc.) and heat generated by self-heating induced by ripple current. Do not place a heating element on the back of the capacitor.

- The product life is given by the following equation.

$$L2 = L1 \times 2^{\frac{T1 - (T2 + \Delta T)}{10}} \quad \text{Where } T1 \geq T2$$

- L1 : Guaranteed life (h) at temperature T<sub>1</sub> (°C)
- L2 : Expected life (h) at temperature T<sub>2</sub> (°C)      \* In the case of a hybrid type, category temperature (°C)
- T1 : Upper category temperature (°C)                      + temperature increase caused by rated ripple current (°C)
- T2 : Ambient temperature of capacitor (°C)
- ΔT : Temperature increase caused by ripple current (°C)

- Do not use the product for a period longer than its specified service life. A capacitor with its service life ended may cause the following problems: rapid degradation of the product characteristics, short circuit, unnecessary activation of the pressure valve, electrolytic solution leakage, etc. Note that the estimated service life is not longer than 15 years due to the limited environment-resistant property of the sealing rubber.
- When the capacitor is used under a high-temperature condition for a long period, minute cracks develop on the surface of the sealing rubber or the case surface turns brown in some cases. These phenomena, however, have no effects on the reliability of the capacitor.
- A capacitor conforming to "AEC-Q200" refers to a capacitor having passed some or all of evaluation test items defined in AEC-Q200.  
To know the detailed specifications of each capacitor or specific evaluation test scores, please contact us.  
We issue a the product specifications sheet for each product ordered. Please confirm the product specifications sheet when you place an order to us.

## Circuit design and circuit board design

- The electrical characteristics change as a result of temperature/frequency fluctuations. Take electrical characteristic changes into consideration when working out a circuit design.
  - (1) Temperature fluctuations
    - High-temperature condition : increase in leak current
    - Low-temperature condition : decrease in capacitance, increase in the tangent to the loss angle, increase in impedance (the hybrid type is excluded), etc.
  - (2) Frequency fluctuations
    - High-frequency condition : decrease in capacitance, increase in the tangent to the loss angle, decrease in impedance, etc.
    - Low-frequency condition : more heat generation by ripple current as a result of an increase in equivalent series resistance
- The group of factors described below may lead to rapid degradation of the capacitor characteristics, short circuit, or electrolytic solution leakage. They may give rise to sharp heat/gas generation, too, in which case the increasing internal pressure actuates the pressure valve, causes the electrolytic solution to leak out of the sealing part, and, in a worst-case scenario, causes an explosion or ignition incident. When a capacitor bursts, it may scatter flammable materials (electrolytic solution, etc.) in its surroundings.
  - (1) Reverse voltage: The capacitor has preset polarity. Do not apply a reverse voltage to the capacitor.  
Confirm the polarity indicated on the capacitor and then use it.
  - (2) Charge/discharge: Avoid using the capacitor in a circuit that frequently repeats sharp charge/discharge cycles or a circuit that requires relatively slow but highly frequent charge/discharge cycles. In cases where you use the capacitor in such circuits, make sure to inform us of the charge/discharge conditions.  
Ensure that a rush current does not exceed 100 A.
  - (3) ON/OFF: Avoid using the capacitor in an on/off circuit that repeatedly switches on and off more than 10,000 times a day. In cases where you use the product in such circuits, make sure to inform us of the circuit conditions, etc.
  - (4) Overvoltage: Do not apply an overvoltage higher than the rated voltage (higher than the surge voltage when the voltage application period is short). A peak value given by superposing a ripple voltage (AC component) on a DC voltage must be equal to or lower than the rated voltage.
  - (5) Ripple current: Do not allow an excessively large ripple current (larger than the rated ripple current specified in the specifications) to flow through the capacitor. Even if a ripple current flow in the capacitor is equal to or smaller than the rated ripple current, a reverse voltage flow may be generated in the capacitor when the DC bias voltage is low flow in the capacitor. Keep the ripple current flow within a range in which no reverse voltage is generated.  
Even if the ripple current flow is kept equal to or smaller than the rated ripple current, using the capacitor for a period longer than its service life intensifies the degradation of the ESR characteristics, resulting in an increase in internal heating caused by the ripple current. As a result, the pressure valve is actuated, the exterior case or rubber swells, the electrolytic solution leaks, and, in a worst-case scenario, the capacitor short-circuits and ignites or explodes.

- Because the impedance of the capacitor is close to the circuit impedance, capacitors connected in parallel in the circuit may damage the whole current balance, in which, a ripple current higher than the rated ripple current may flow in some of the capacitors. To prevent concentration of ripple current on the low-impedance side, use capacitors with the same part number and avoid the partiality of cable impedances. Do not use capacitors connected in series.
- When the capacitor is mounted on a double-side wiring board, do not place the wiring pattern directly underneath where the product is mounted. In case the electrolytic solution leaks out, it may short-circuit the pattern and cause tracking or migration. Consider a case where the product is a radial lead capacitor and is mounted on a board with through-holes. In this case, if the sealing part of the capacitor and the board surface stick close to each other, solder flows up to the capacitor during a dip soldering process, which may cause short circuit between the anode and cathode of the capacitor. In such a case, the outer laminate of the product may be damaged. The position of holes, therefore, must be determined properly.
- When designing a printed board carrying radial lead capacitors, make through-holes across the gap equal to the gap between the leads (terminals) of the capacitor. If the gap between the through-holes is narrower or wider than the gap between the leads, stress is applied to the leads when the capacitor is inserted in the holes. This may result in increasing leak current, short circuit, wire breaking, or electrolytic solution leakage.
- A capacitor which has the pressure valve on the case must be provided with a space formed above the pressure valve so that the pressure valve operates without hinderance. When the product is 6.3 mm to 16 mm in diameter, form a space of 2 mm or larger. When the product is 18 mm in diameter, form a space of 3 mm or larger. If the space is not large enough, it will impair the operability of the pressure valve and may lead to an explosion incident.
- Design the circuit in such that the pattern, especially a line pattern carrying high voltage or large current, is not formed above the pressure valve. Upon its activation, the pressure valve emits a flammable high-temperature gas of over 100 °C. This may cause a secondary accident, such as the gas condensing on the pattern and the wire sheathing being melted and catching on fire.
- Be careful with resonance of the capacitor mounted on the board. When a large load is applied to the capacitor at the frequency close to the resonance frequency, it may cause the capacitor to come off or widely change its characteristics.
- Completely isolate the case of the capacitor from the cathode terminal and the circuit pattern.
- The laminate or outer sleeve covering of the product is for displaying information on the product and does not have a guaranteed insulating function. The laminate may turn brown under a high-temperature condition. However, that does not cause problems with markings recognition on the product surface or electrical performance. The outer sleeve may crack when dipped in a xylene or toluene solution and exposed to high temperature.

## Mounting conditions

- Do not reuse a capacitor that was incorporated in a circuit set and energized in the past. Do not use a capacitor that was dropped on the floor. Do not use a capacitor in its compressed form. Compressing the capacitor makes it less airtight, resulting in poor performance, shorter guaranteed life, and electrolyte leakage.
- A re-striking voltage is generated in a capacitor in some cases. In such a case, let the capacitor discharge through a resistor of about 1 kΩ.
- When a capacitor is kept in storage for a long period, you may find the leak current from the capacitor has increased. In such a case, make voltage adjustment through a resistor of about 1 kΩ.
- Before mounting the capacitor on the board, confirm the ratings (capacitance, rated voltage, etc.) and polarity of the capacitor. Before mounting a surface-mounted type capacitor, confirm its terminal dimensions and land size. Before mounting a radial lead type capacitor, confirm its terminal interval and hole interval. If the terminal interval is not the specified one, stress is applied to internal elements, which may cause problems, such as a short circuit and insufficient mounting strength. When the terminal interval and the hole interval of the radial lead type capacitor do not match and therefore the capacitor's leads need to be readjusted, make sure that the readjustment does not apply any stress to the capacitor's body.

- Confirm the applied pressure when using an automatically mounting process for a surface-mounted type capacitor. Excessive pressure may result in increasing leak current, short circuit, the capacitor coming off from the board, and the like. When automatically mounting the radial lead type capacitor, check the wear of a cutter for cutting the leads and confirm that the angle of clinching the leads is not too acute with regards to the board. Clinching the leads at too acute of an angle applies tensile stress to the leads, which may lead to destruction of the capacitor.
- Follow soldering conditions (preheating, soldering temperature/time, the number of soldering, etc.) in the specification sheet. A high peak temperature or a long heating time causes the degradation of electrical characteristics or a reduction in the guaranteed life. Note that the specified soldering conditions indicate conditions under which the degradation of capacitor characteristics do not occur but do not indicate conditions under which stable soldering can be performed. Check and set conditions under which stable soldering can be performed, on a case-by-case basis. Measure the temperature of the capacitor, using a thermocouple bonded to the top of the capacitor with an epoxy-based adhesive. This temperature measurement must be conducted in a mass-production setup.
- The surface-mounted type capacitor is soldered by reflow soldering only. It cannot be soldered by flow soldering or dip soldering. Carry out reflow soldering with an atmospheric heat transfer method using infrared hot air, etc. When carrying out two rounds of reflow processes, carry out the second reflow process after the capacitor's temperature settles down to a normal temperature. In the case of VPS reflow, a sharp rise in the capacitor temperature causes a change in the characteristics and appearance of the capacitor, which may give rise to a problem with capacitor mounting. We therefore recommend execution of VPS flow at a temperature rise rate of 3 °C/second or lower. For more information about this matter, please contact us.
- Reflow soldering, under the reflow conditions we recommend, might result in discoloring or swelling of the case or crack formation on the ink mark indicating the cathode. These minor problems, however, do not affect the reliability of the capacitor at all.
- A 6.3-mm diameter vibration-resistant capacitor has a structure that covers the auxiliary terminals to the sides of a seat plate. In cases where you confirm formation of a fillet on the sides of the auxiliary terminals by an image recognition means, etc., examine soldering conditions for the formation of a sufficient fillet on the auxiliary terminals in advance before carrying out the soldering process. Even if the formation of a sufficient fillet on the auxiliary terminals is not confirmed, a solder junction between the lower surface of the auxiliary terminals and the board ensures vibration-resistant performance, meaning the reliability of the capacitor is not affected.
- The radial lead type capacitor cannot be soldered by reflow soldering. Do not dip the capacitor body, except the leads, in solder. Heat from the solder raises the internal pressure of the capacitor and destroys it. Solder the capacitor according to the following soldering conditions: soldering temperature of 260 °C ±5 °C and soldering time of 10 seconds ±1 second.
- Ensure that other components do not come in contact with the capacitor during the soldering process. When a radial lead type capacitor is set in close contact with the board, check the soldered state of the capacitor well, because its sealing rubber has no venting structure.
- When manually soldering the capacitor, follow the soldering conditions (soldering temperature/time) specified in the specification sheet or adopt a soldering temperature of 350 °C and a soldering time of 3 seconds or less. When you need to remove a capacitor already soldered, remove it after the solder is melted sufficiently so that no stress is applied to the terminals of the capacitor. Be careful not to let the solder iron tip touch the capacitor. The solder iron touching the capacitor may damage the capacitor.
- When the temperature of the capacitor becomes extremely high due to preheating, solidification of the setting resin, etc., may cause the outer sleeve of the capacitor to shrink or crack. When treating the capacitor in a thermosetting furnace, etc., place the capacitor in an atmosphere of 150 °C for 2 minutes or less.
- Do not tilt or twist the capacitor soldered to a printed board or hold the capacitor to carry the board or hit the capacitor against something. Such actions apply a force to the internal elements through the terminals and may destroy the product.
- Using highly active halogenous (chlorine-based or bromic) solder flux poses a concern that residual solder flux will have negative impact on the performance and reliability of the capacitor. Check the influence of residual solder flux before using such solder flux.



## Storage conditions

- A capacitor left for a long period is prone to have a greater flow of leak current. This happens because the oxide film deteriorates under a no-load condition. Voltage application to the capacitor reduces the leak current. However, at the start of voltage application, a large flow of film recovery current increases the leak current, which may cause a circuit failure, etc.
- The storage period of a capacitor is 42 months from the shipment inspection day. However, the storage period of capacitors not listed in the following table is specified as 12 months. Store the capacitor in a place where a normal temperature condition (5°C to 35°C) and a normal humidity condition (45% to 85%) are maintained and direct sunlight is blocked.

Product category	Series	Storage period
Hybrid type	All hybrid series	42 months from the shipment inspection day
Surface-mounted type other than the hybrid type	S (hot lead-free reflow), HA (hot lead-free reflow) HB (hot lead-free reflow, 5.4 mm in height) HC, HD, FCA, FC, FKA, FK, FKS, FP, FT, FH, FN TG, TK, TP, TC, TCU, TQ	
Radial lead type other than the hybrid type	FC-A, FK-A, HD-A, TA-A, TP-A, FP-A	

- Avoid storing the capacitor in environments not specified in the delivery specification sheet or in the following environments or conditions.
  - (1) Used at a temperature higher than the upper limit category temperature or lower than the lower limit category temperature
  - (2) Environments where the capacitor is exposed to water, salt water, or oil
  - (3) Environments where dew concentrates on the capacitor
  - (4) Environments filled with a toxic gas (hydrogen sulfide, sulfuric acid, nitrous acid, chlorine and chlorine compound, bromine and bromine compound, ammonia, etc.)
  - (5) Environments where the product is exposed to ozone, radiation, UV-rays, etc.
  - (6) Environments where vibrations or mechanical shocks exceeding a specified range is applied to the capacitor

## Reference information

### Guidelines

Some of the product use guidelines described herein are excerpted from JEITA RCR-2367D "Safety application guide for fixed aluminum electrolytic capacitors for use in electronic equipment," a technical report issued by the Japan Electronics and Information Technology Industries Association on October 2017. For more detailed information, please see the above technical report.

### Intellectual property

Panasonic Group provides customers with safe products and services. We are also making great efforts to protect our intellectual property rights for Panasonic Group products. Typical patents related to this product are as follows. (Hybrid type)

[U.S. patent]

USP Nos. 7497879, 7621970, 9208954, 9595396, 9966200, 10453618, 10559432, 10679800, 10685788, and 10790095.

[Japanese patent]

Japanese Patent No. 5360250

[European patent]

EP-A Nos. 1808875 and 2698802

**Line up**

**Surface mount type**

Series	Part No.	Features	Small size	Large cap.	High ripple	High temp.	Long life	Category temperature range (°C)	Rated voltage range (V)	ESR (mΩ)	Capacitance range (μF)	Size code	Size (mm)	
													∅D	L
ZA	EEHZA---	Low ESR High ripple current Long life 105 °C 10000 h	●					-55 to 105	25 to 50	80 to 120	10 to 33	C	5.0	5.8
									25 to 63	50 to 120	10 to 56	D	6.3	5.8
										30 to 80	22 to 100	D8	6.3	7.7
									25 to 80	27 to 45	22 to 220	F	8.0	10.2
20 to 36	33 to 330	G	10.0	10.2										
ZC	EEHZC---	Low ESR High ripple current Long life 125 °C 4000 h	●				-55 to 125	25 to 50	80 to 120	10 to 33	C	5.0	5.8	
								25 to 63	50 to 120	10 to 56	D	6.3	5.8	
									30 to 80	22 to 100	D8	6.3	7.7	
								25 to 80	27 to 45	22 to 220	F	8.0	10.2	
20 to 36	33 to 330	G	10.0	10.2										
ZK	EEHZK---	Large capacitance High ripple current Long life 125 °C 4000 h	●	●	●		-55 to 125	25 to 35	80 to 100	33 to 47	C	5.0	5.8	
									50 to 60	56 to 82	D	6.3	5.8	
									30 to 35	100 to 150	D8	6.3	7.7	
									27	180 to 270	F	8.0	10.2	
									20	330 to 470	G	10.0	10.2	
ZKU	EEHZK--U-	Large capacitance Long life 125 °C 4000 h	●	●	●		-55 to 125	25 to 35	80 to 100	39 to 56	C	5.0	5.8	
									50 to 60	68 to 100	D	6.3	5.8	
									30 to 35	120 to 180	D8	6.3	7.7	
									27	220 to 330	F	8.0	10.2	
									20	390 to 560	G	10.0	10.2	
<b>NEW</b> ZL	EEHZL---	125 °C 4000 h 135 °C 4000 h	●	●	●		-55 to 135	25 to 35	58 to 60	47 to 82	C	5.0	5.8	
									38 to 40	82 to 150	D	6.3	5.8	
									24 to 26	150 to 220	D8	6.3	7.7	
									18 to 20	270 to 470	F	8.0	10.2	
									14 to 16	470 to 680	G	10.0	10.2	
ZT	EEHZT---	125 °C 4000 h		●	●		-55 to 125	25 to 63	22 to 32	33 to 220	F	8.0	10.2	
									16 to 25	56 to 330	G	10.0	10.2	
ZTU	EEHZT--U-	125 °C 4000 h 135 °C 4000 h		●	●		-55 to 135	25 to 35	22	220 to 330	F	8.0	10.2	
									16	390 to 560	G	10.0	10.2	
<b>NEW</b> ZV	EEHZV---	125 °C 4000 h 135 °C 4000 h		●	●		-55 to 135	25 to 63	16 to 22	33 to 220	F	8.0	10.2	
									12 to 16	56 to 330	G	10.0	10.2	
ZS	EEHZS---	125 °C 4000 h 135 °C 4000 h		●	●		-55 to 135	25 to 63	14 to 19	100 to 470	G12	10.0	12.5	
									11 to 15	150 to 560	G16	10.0	16.5	
ZSU	EEHZS--U-	125 °C 4000 h		●	●		-55 to 125	25 to 63	14 to 19	120 to 680	G12	10.0	12.5	
									11 to 15	180 to 1000	G16	10.0	16.5	
ZU	EEHZU---	125 °C 4000 h 135 °C 4000 h		●	●		-55 to 135	25 to 63	10 to 12	100 to 470	G12	10.0	12.5	
									8 to 10	150 to 560	G16	10.0	16.5	
ZUU	EEHZU--U-	125 °C 4000 h 135 °C 4000 h		●	●		-55 to 135	25 to 63	10 to 12	120 to 680	G12	10.0	12.5	
									8 to 10	180 to 1000	G16	10.0	16.5	
ZE	EEHZE---	145 °C 2000 h 135 °C 4000 h			●	●	-55 to 145	25 to 63	27 to 40	33 to 220	F	8.0	10.2	
									20 to 30	56 to 330	G	10.0	10.2	
ZF	EEHZF---	150 °C 1000 h			●	●	-55 to 150	25 to 63	27 to 40	33 to 150	F	8.0	10.2	
									20 to 30	56 to 270	G	10.0	10.2	

**Line up**

**Radial lead type**

Series	Part No.	Features	Small size	Large cap.	High ripple	High temp.	Long life	Category temperature range (°C)	Rated voltage range (V)	ESR (mΩ)	Capacitance range (μF)	Size code	Size (mm)	
													∅D	L
ZA-A	EEHAZA---B	105 °C 10000 h						-55 to 105	25 to 80	27 to 45	22 to 220	F	8.0	9.5
										20 to 36	33 to 330	G	10.0	9.5
ZC-A	EEHAZC---B	125 °C 4000 h					●	-55 to 125	25 to 80	27 to 45	22 to 220	F	8.0	9.5
										20 to 36	33 to 330	G	10.0	9.5
ZK-A	EEHAZK---B	125 °C 4000 h		●	●			-55 to 125	25 to 35	27	180 to 270	F	8.0	9.5
										20	330 to 470	G	10.0	9.5
ZKU -A	EEHAZK--UB	125 °C 4000 h		●	●			-55 to 125	25 to 35	27	220 to 330	F	8.0	9.5
										20	390 to 560	G	10.0	9.5
ZT-A	EEHAZT---B	125 °C 4000 h		●	●			-55 to 125	25 to 63	22 to 32	33 to 220	F	8.0	9.5
										16 to 25	56 to 330	G	10.0	9.5
ZS-A	EEHAZS---B	125 °C 4000 h 135 °C 4000 h		●	●			-55 to 135	25 to 63	14 to 19	100 to 470	G12	10.0	11.7
										11 to 15	150 to 560	G16	10.0	15.7
ZSU -A	EEHAZS--UB	125 °C 4000 h		●	●			-55 to 125	25 to 63	14 to 19	120 to 680	G12	10.0	11.7
										11 to 15	180 to 1000	G16	10.0	15.7
ZE-A	EEHAZE---B	145 °C 2000 h 135 °C 4000 h				●	●	-55 to 145	25 to 63	27 to 40	33 to 220	F	8.0	9.5
										20 to 30	56 to 330	G	10.0	9.5
ZF-A	EEHAZF---B	150 °C 1000 h				●	●	-55 to 150	25 to 63	27 to 40	33 to 150	F	8.0	9.5
										20 to 30	56 to 270	G	10.0	9.5

**Series flow chart**

● Surface mount type

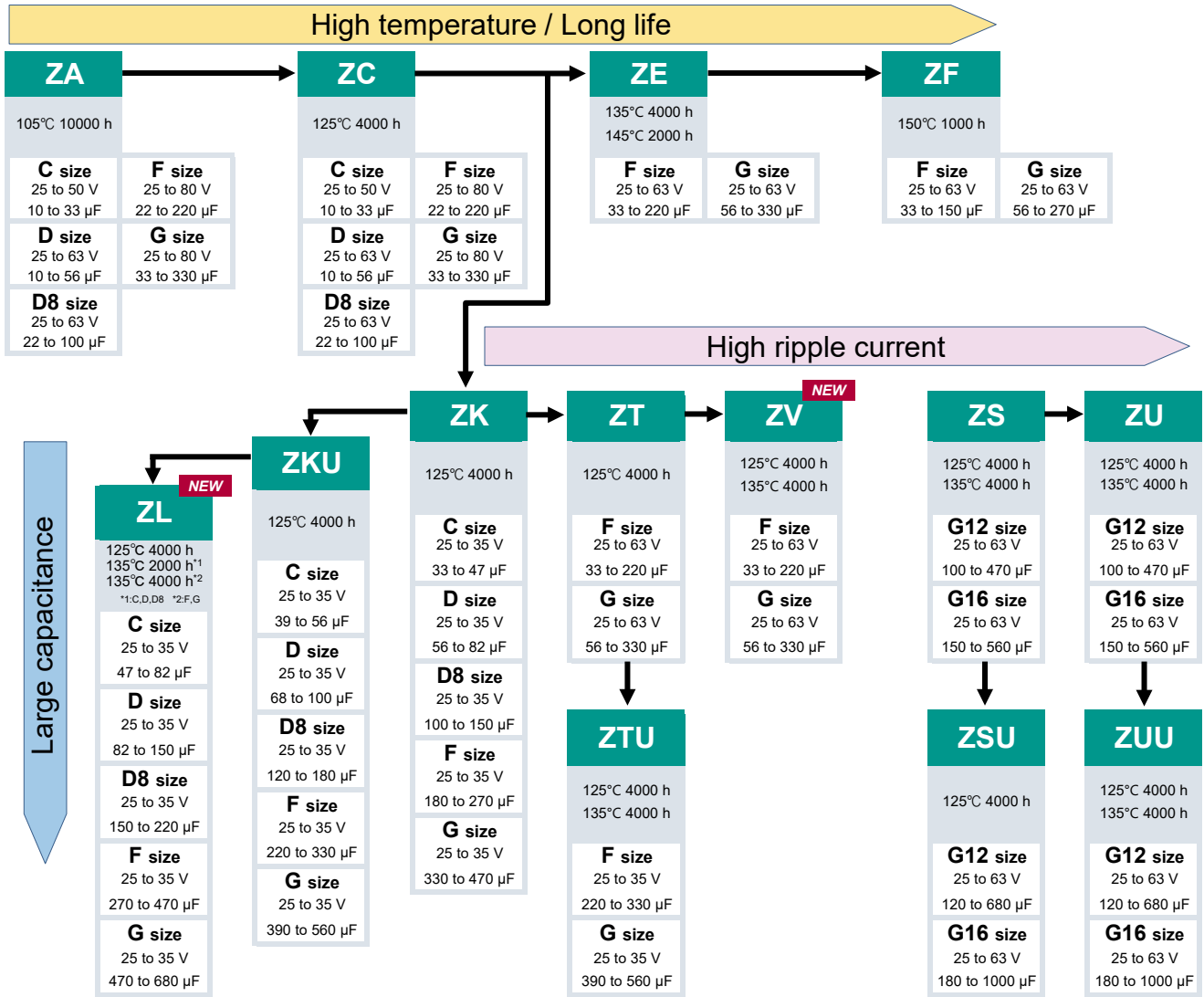

● Radial lead type

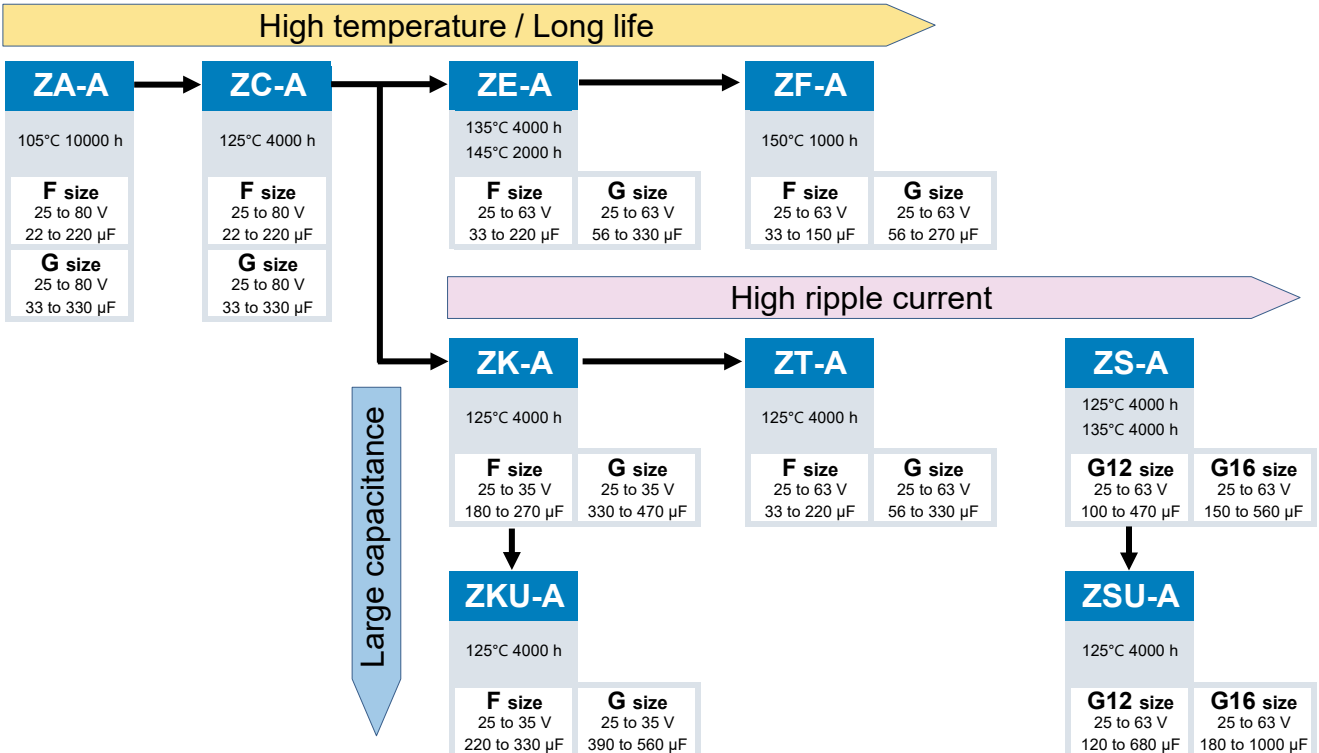

**Voltage - Capacitance table (SMD type) (Vol. : 25 to 80 V / Cap. : 10 to 120 μF)**

Series [Size]  
(ESR mΩ)

W	μF	10	22	27	33	39	47	56	68	82	100	120
25			ZA [C] (80)		ZA [C] (80)		ZA [D] (50)	ZA [D] (50)	ZA [D8] (30)	ZK [D] (50)	ZA [D8] (30)	
			ZC [C] (80)		ZC [C] (80)		ZC [D] (50)	ZC [D] (50)	ZC [D8] (30)	ZL [C] (58)	ZC [D8] (30)	
							ZK [C] (80)	ZKU [C] (80)	ZK [D] (50)		ZKU [D] (50)	
35		ZA [C] (100)	ZA [C] (100)	ZA [D] (60)	ZA [D] (60)	ZKU [C] (100)	ZA [D] (60)	ZK [D] (60)	ZA [D8] (35)	ZL [D] (40)	ZA [F] (27)	ZKU [D8] (35)
		ZC [C] (100)	ZC [C] (100)		ZC [D] (60)		ZC [D] (60)		ZC [D8] (35)		ZC [F] (27)	
					ZK [C] (100)		ZL [C] (60)		ZKU [D] (60)		ZK [D8] (35)	
											ZF [F] (30)	
50		ZA [C] (120)	ZA [D] (80)		ZA [D8] (40)		ZA [F] (30)	ZF [F] (35)	ZA [F] (30)		ZA [G] (28)	ZC [G] (28)
		ZC [C] (120)	ZC [D] (80)		ZC [D8] (40)		ZC [F] (30)		ZC [F] (30)		ZC [G] (28)	ZT [G] (23)
									ZT [F] (25)		ZT [G] (23)	ZV [G] (14)
									ZE [F] (30)		ZE [G] (28)	
									ZV [F] (19)		ZF [G] (28)	
											ZV [G] (14)	
63		ZA [D] (120)	ZA [D8] (80)		ZA [F] (40)		ZA [F] (40)	ZA [G] (30)	ZA [G] (30)	ZA [G] (30)	ZS [G12] (19)	ZSU [G12] (19)
		ZC [D] (120)	ZC [D8] (80)		ZC [F] (40)		ZC [F] (40)	ZC [G] (30)	ZC [G] (30)	ZC [G] (30)	ZU [G12] (12)	ZUU [G12] (12)
					ZT [F] (32)		ZT [F] (32)	ZT [G] (25)	ZT [G] (25)	ZT [G] (25)		
					ZE [F] (40)		ZV [F] (22)	ZE [G] (30)	ZV [G] (16)	ZE [G] (30)		
					ZF [F] (40)			ZF [G] (30)		ZV [G] (16)		
					ZV [F] (22)			ZV [G] (16)				
80			ZA [F] (45)		ZA [G] (36)		ZA [G] (36)					
			ZC [F] (45)		ZC [G] (36)		ZC [G] (36)					

Size list ø x L (mm)

C	5.0x5.8	D	6.3x5.8	F	8.0x10.2	G	10.0x10.2
		D8	6.3x7.7			G12	10.0x12.5
						G16	10.0x16.5

**Voltage - Capacitance table (SMD type) (Vol. : 25 to 80 V / Cap. : 150 to 1000 µF)**

Series [Size]  
(ESR mΩ)

V	µF	150	180	220	270	330	390	470	560	680	1000
25		ZA [F] (27)	ZKU [D8] (30)	ZA [F] (27)	ZK [F] (27)	ZA [G] (20)		ZK [G] (20)	ZKU [G] (20)	ZSU [G12] (14)	ZSU [G16] (11)
		ZC [F] (27)		ZC [F] (27)	ZF [G] (20)	ZC [G] (20)		ZS [G12] (14)	ZS [G16] (11)	ZUU [G12] (10)	ZUU [G16] (8)
		ZK [D8] (30)		ZT [F] (22)		ZKU [F] (27)		ZU [G12] (10)	ZU [G16] (8)	ZL [G] (14)	
		ZF [F] (27)		ZE [F] (27)		ZT [G] (16)		ZL [F] (18)	ZTU [G] (16)		
		ZL [D] (38)		ZV [F] (16)		ZE [G] (20)					
				ZL [D8] (24)		ZTU [F] (22)					
						ZV [G] (12)					
35		ZA [F] (27)	ZK [F] (27)	ZA [G] (20)	ZA [G] (20)	ZK [G] (20)	ZKU [G] (20)	ZS [G16] (11)		ZSU [G16] (11)	
		ZC [F] (27)		ZC [G] (20)	ZC [G] (20)	ZS [G12] (14)	ZTU [G] (16)	ZSU [G12] (14)		ZUU [G16] (9)	
		ZT [F] (22)		ZKU [F] (27)	ZT [G] (16)	ZU [G12] (11)		ZU [G16] (9)			
		ZE [F] (27)		ZTU [F] (22)	ZE [G] (20)			ZUU [G12] (11)			
		ZF [G] (23)			ZV [G] (12)			ZL [G] (16)			
		ZV [F] (16)			ZL [F] (20)						
		ZL [D8] (26)									
50		ZS [G12] (17)	ZSU [G12] (17)	ZS [G16] (13)	ZSU [G16] (13)						
		ZU [G12] (12)	ZUU [G12] (12)	ZU [G16] (10)	ZUU [G16] (10)						
63		ZS [G16] (15)	ZSU [G16] (15)								
		ZU [G16] (10)	ZUU [G16] (10)								
80											

Size list ø x L (mm)

C	5.0x5.8	D	6.3x5.8	F	8.0x10.2	G	10.0x10.2
		D8	6.3x7.7			G12	10.0x12.5
						G16	10.0x16.5

**Voltage - Capacitance table (Radial lead type) (Vol. : 25 to 80 V / Cap. : 22 to 150  $\mu$ F)**

Series [Size]  
(ESR m $\Omega$ )

V	$\mu$ F	22	27	33	39	47	56	68	82	100	120	150
25												ZA [F] (27)
												ZC [F] (27)
												ZF [F] (27)
35										ZA [F] (27)		ZA [F] (27)
										ZC [F] (27)		ZC [F] (27)
										ZF [F] (30)		ZK [F] (22)
												ZE [F] (27)
												ZF [G] (23)
50						ZA [F] (30)	ZF [F] (35)	ZA [F] (30)		ZA [G] (28)	ZC [G] (28)	ZS [G12] (17)
						ZC [F] (30)		ZC [F] (30)		ZC [G] (28)	ZT [G] (23)	
								ZT [F] (25)		ZT [G] (23)		
								ZE [F] (30)		ZE [G] (28)		
										ZF [G] (28)		
63			ZA [F] (40)			ZA [F] (40)	ZA [G] (30)	ZA [G] (30)	ZA [G] (30)	ZS [G12] (19)	ZSU [G12] (19)	ZS [G16] (15)
			ZC [F] (40)			ZC [F] (40)	ZC [G] (30)	ZC [G] (30)	ZC [G] (30)			
			ZT [F] (32)			ZT [F] (32)	ZT [G] (25)	ZT [G] (25)	ZT [G] (25)			
			ZE [F] (40)				ZE [G] (30)		ZE [G] (30)			
			ZF [F] (40)				ZF [G] (30)					
80		ZA [F] (45)		ZA [G] (36)		ZA [G] (36)						
		ZC [F] (45)		ZC [G] (36)		ZC [G] (36)						

Size list  $\phi$  x L (mm)

F	8.0 x 9.5	G	10.0 x 9.5	G12	10.0 x 11.7	G16	10.0 x 15.7
---	-----------	---	------------	-----	-------------	-----	-------------

**Voltage - Capacitance table (Radial lead type) (Vol. : 25 to 80 V / Cap. : 180 to 1000 μF)**

Series [Size]  
(ESR mΩ)

V	μF	180	220	270	330	390	470	560	680	1000
25			ZA [F] (27)	ZK [F] (27)	ZA [G] (20)		ZK [G] (20)	ZKU [G] (20)	ZSU [G12] (14)	ZSU [G16] (11)
			ZC [F] (27)	ZF [G] (20)	ZC [G] (20)		ZS [G12] (14)	ZS [G16] (11)		
			ZT [F] (22)		ZKU [F] (27)					
			ZE [F] (27)		ZT [G] (16)					
					ZE [G] (20)					
35		ZK [F] (27)	ZA [G] (20)	ZA [G] (20)	ZK [G] (20)	ZKU [G] (20)	ZS [G16] (11)		ZSU [G16] (11)	
			ZC [G] (20)	ZC [G] (20)	ZS [G12] (14)		ZSU [G12] (14)			
			ZKU [F] (27)	ZT [G] (16)						
				ZE [G] (20)						
50		ZSU [G12] (17)	ZS [G16] (13)	ZSU [G16] (13)						
63		ZSU [G16] (15)								
80										

Size list ø x L (mm)

F	8.0 x 9.5	G	10.0 x 9.5	G12	10.0 x 11.7	G16	10.0 x 15.7
---	-----------	---	------------	-----	-------------	-----	-------------



**Explanation of part numbers**

◇ Part number system

• Surface mount type

<b>EEH</b> Product classification 3 figures	<b>ZC</b> Series 2 figures	<b>1E</b> Voltage code 1 to 2 figures	<b>101</b> Capacitance code 3 figures	<b>X</b> Size code 0 to 1 figure	<b>*</b> Special code 0 to 1 figure	<b>P</b> Taping code 1 figure
	Series Code	Rated voltage (V) Code	Cap. (μF) Code	øD x L Code	Dia øD Code	Tape width (mm) Code
	ZA ZA ZC ZC ZK ZK ZKU ZK ZL ZL ZT ZT ZTU ZT ZV ZV ZS ZS ZSU ZS ZU ZU ZUU ZU ZE ZE ZF ZF	25 1E 35 1V 50 1H 63 1J 80 1K	10 100 22 220 27 270 33 330 39 390 47 470 56 560 68 680 82 820 100 101 120 121 150 151 180 181 220 221 270 271 330 331 390 391 470 471 560 561 680 681 1000 102	6.3 x 7.7 (D8) X	Miniaturization product U	12 R 16 ~ 24 P Vibration-proof V
				* Only D8 is marked with X		

\* If the total figures number of the part number exceeds 12 figures, "1" is omitted.  
e.g.) 1E → E

• Radial lead type

<b>EEHA</b> Product classification 4 figures	<b>ZC</b> Series 2 figures	<b>1E</b> Voltage code 1 to 2 figure	<b>151</b> Capacitance code 3 figures	<b>*</b> Special code 0 to 1 figure	<b>B</b> Taping code 1 figure
	Series Code	Rated voltage (V) Code	Cap. (μF) Code	Dia øD Code	Lead space (mm) Code
	ZA ZA ZC ZC ZK ZK ZKU ZK ZT ZT ZS ZS ZSU ZS ZE ZE ZF ZF	25 1E 35 1V 50 1H 63 1J 80 1K	22 220 33 330 47 470 56 560 68 680 82 820 100 101 120 121 150 151 180 181 220 221 270 271 330 331 390 391 470 471 560 561 680 681 1000 102	Miniaturization product U	3.5, 5.0 B

\* If the total figures number of the part number exceeds 12 figures, "1" is omitted.  
e.g.) 1E → E

**Recommended reflow soldering**

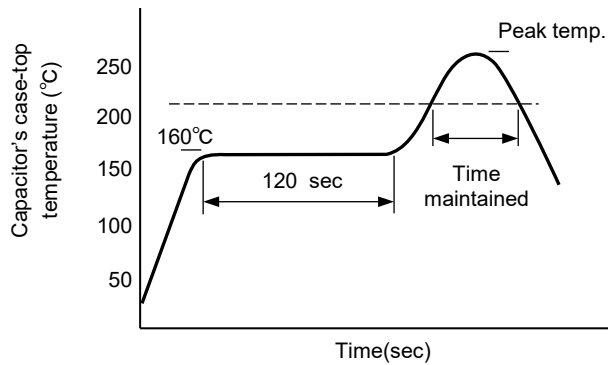

Size code	C, D, D8	F, G, G12, G16	
Peak temp.	260°C (255°C)	245°C	260°C
Time in peak temperature	≥ 250°C 5 s (10 s)	≥ 240°C 10 s	≥ 250°C 5 s
Time maintained	≥ 230°C 30 s	≥ 230°C 30 s	≥ 230°C 30 s
	≥ 217°C 40 s	≥ 217°C 40 s	≥ 217°C 40 s
	≥ 200°C 70 s	≥ 200°C 70 s	≥ 200°C 70 s
Reflow cycles	2 times	2 times	1 time

\* For reflow, use a thermal condition system such as infrared and radiation (IR) or hot blas.

\* Reflow temperature is measured on capacitor's case top.

**Specifications for radial lead type**

- Flow soldering condition
- < RoHS compliant >

	Temperature	Time	Flow number
Soldering condition	260°C + 5°C or less	10 sec +1 sec or less	1 time

**Vibration-proof products**

The size and shape are different from standard products. Please inquire details of our company.

< Size code : D, D8 >

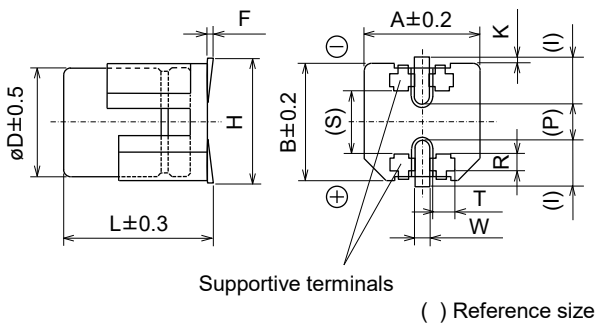

Unit : mm

Size code	øD	L	A, B	H max.	F	I	W
D	6.3	6.1	6.6	7.8	0 to +0.15	2.4	0.65±0.1
D8	6.3	8.0	6.6	7.8	0 to +0.15	2.4	0.65±0.1

Size code	P	K	R	S	T
D	2.2	0.35 <sup>+0.15</sup> <sub>-0.20</sub>	1.1±0.2	3.3	1.05±0.2
D8	2.2	0.35 <sup>+0.15</sup> <sub>-0.20</sub>	1.1±0.2	3.3	1.05±0.2

< Size code : F, G, G12, G16 >

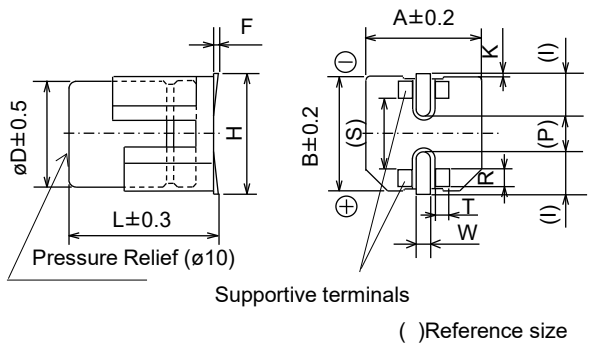

Unit : mm

Size code	øD	L	A, B	H max.	F	I	W
F	8.0	10.5	8.3	10.0	0 to +0.15	3.4	1.2±0.2
G	10.0	10.5	10.3	12.0	0 to +0.15	3.5	1.2±0.2
G12	10.0	12.8	10.3	11.0 <sup>*1</sup>	0 to +0.15	3.2	1.2±0.2
G16	10.0	16.8	10.3	11.0 <sup>*1</sup>	0 to +0.15	3.2	1.2±0.2

<sup>\*1</sup>:±0.2

Size code	P	K	R	S	T
F	3.1	0.70±0.2	0.70±0.2	5.3	1.3±0.2
G	4.6	0.70±0.2	0.70±0.2	6.9	1.3±0.2
G12	4.6	—	0.70±0.2	6.9	1.3±0.2
G16	4.6	—	0.70±0.2	6.9	1.3±0.2

**Mounting specification**

**Land / Pad pattern**

The circuit board land/pad pattern size for chip capacitors is specified in the following table.  
The land pitch influences installation strength.

● Standard products

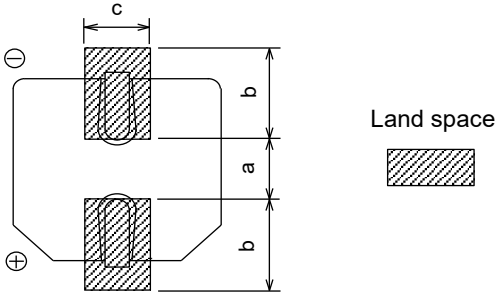

Unit : mm

Size code	a	b	c
C : $\phi 5 \times L5.8$	1.5	2.8	1.6
D : $\phi 6.3 \times L5.8$	1.8	3.2	1.6
D8 : $\phi 6.3 \times L7.7$	1.8	3.2	1.6
F : $\phi 8 \times L10.2$	3.1	4.0	2.0
G : $\phi 10 \times L10.2$	4.6	4.1	2.0
G12 : $\phi 10 \times L12.5$	4.6	4.1	2.0
G16 : $\phi 10 \times L16.5$	4.6	4.1	2.0

When size "a" is wide, back fillet can be made, decreasing fitting strength.

\* Take mounting conditions, solderability and fitting strength into consideration when selecting parts for your design.

● Vibration-proof products

< Size code : D, D8 >

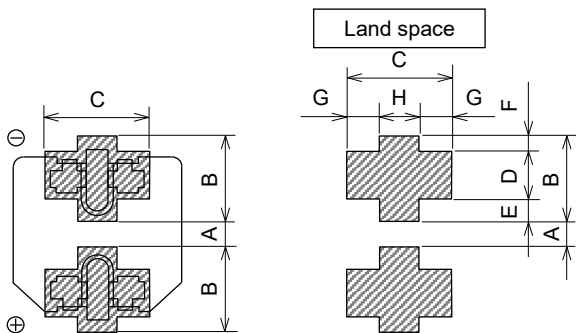

Unit : mm

Size code	A	B	C	D
D : $\phi 6.3 \times L6.1$	1.2	3.6	3.2	2.0
D8 : $\phi 6.3 \times L8.0$	1.2	3.6	3.2	2.0

Size code	E	F	G	H
D : $\phi 6.3 \times L6.1$	0.95	0.65	1.0	1.2
D8 : $\phi 6.3 \times L8.0$	0.95	0.65	1.0	1.2

Larger dimension of "A" may prevent back fillet from being formed adequately to obtain required solder strength.

< Size code : F, G, G12, G16 >

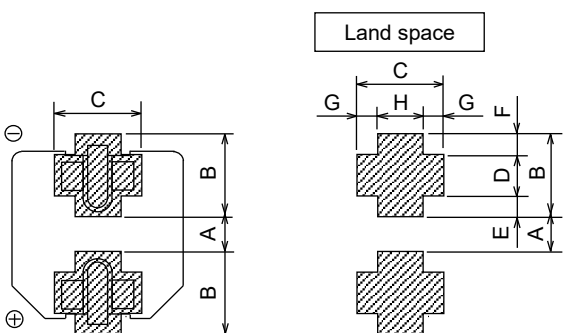

Unit : mm

Size code	A	B	C	D
F : $\phi 8 \times L10.5$	2.7	4.0	4.7	1.3
G : $\phi 10 \times L10.5$	3.9	4.4	4.7	1.3
G12 : $\phi 10 \times L12.8$	3.9	4.4	4.7	1.3
G16 : $\phi 10 \times L16.8$	3.9	4.4	4.7	1.3

Size code	E	F	G	H
F : $\phi 8 \times L10.5$	1.0	1.7	1.1	2.5
G : $\phi 10 \times L10.5$	1.2	1.9	1.1	2.5
G12 : $\phi 10 \times L12.8$	1.2	1.9	1.1	2.5
G16 : $\phi 10 \times L16.8$	1.2	1.9	1.1	2.5

When size "A" is wide, back fillet can be made, decreasing fitting strength.

\* Take mounting conditions, solderability and fitting strength into consideration when selecting parts for your design.

\* The vibration-proof capacitors of size  $\phi 6.3$  has support terminals extending from the bottom side to the lead edge. Then, make sure to find appropriate soldering conditions to form fillet on the support terminals if required for appearance inspection.

**Packaging specifications**

**Specifications for surface mount type**

● Reel dimensions (not to scale)

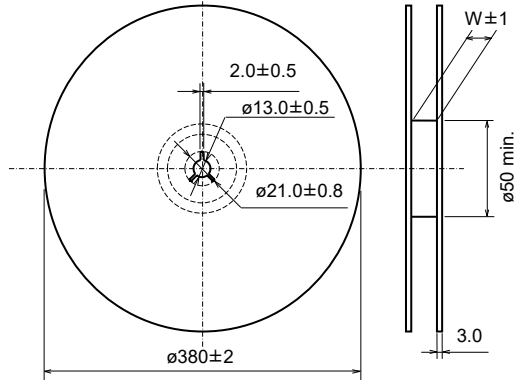

Unit : mm

Size code	W
C	14.0
D, D8	18.0
F, G, G12, G16	26.0

● Taping dimensions

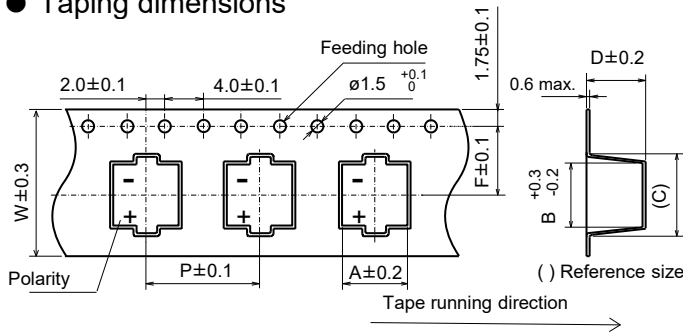

※Ask factory for technical specifications

**Radial lead type**

● Taping dimensions

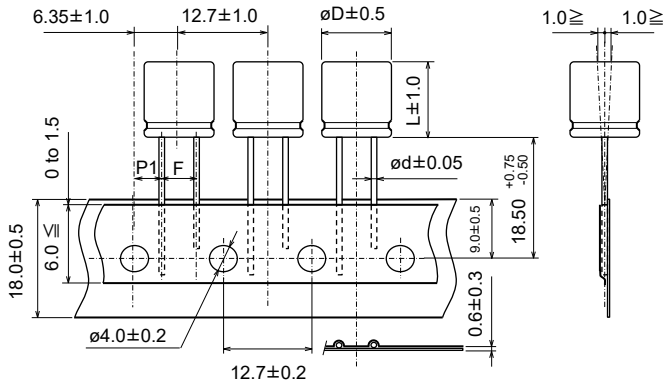

Unit : mm

Size code	øD	L	ød	F	P1
F	8.0	9.5	0.6	3.5±0.5	4.60±0.50
G	10.0	9.5	0.6	5.0+0.8/-0.2	3.85±0.50
G12	10.0	11.7	0.8	5.0+0.8/-0.2	3.85±0.50
G16	10.0	15.7	0.8	5.0+0.8/-0.2	3.85±0.50

● Dimensions of outer carton box

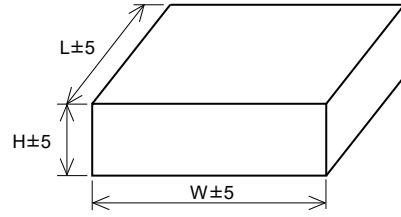

Unit : mm

Size code	H	W, L
C	180	395
D, D8	220	395
F, G, G12, G16	180	395

● Min.packing quantity

Size code	Min.packing quantity (pcs.)
C, D	1000
D8	900
F, G	500
G12	400
G16	250

Unit : mm

Size code	A	B	C	D	P	F	W
C	5.7	5.7	8.0	6.4	12.0	5.5	12.0
D	7.0	7.0	9.0	6.4	12.0	7.5	16.0
D8	7.0	7.0	9.0	8.4	12.0	7.5	16.0
F	8.7	8.7	12.5	11.0	16.0	11.5	24.0
G	10.7	10.7	14.5	11.0	16.0	11.5	24.0
G12	10.7	10.7	14.5	13.7	16.0	11.5	24.0
G16	10.7	10.7	14.5	17.5	20.0	11.5	24.0

● Dimensions of outer carton box / Packaging method

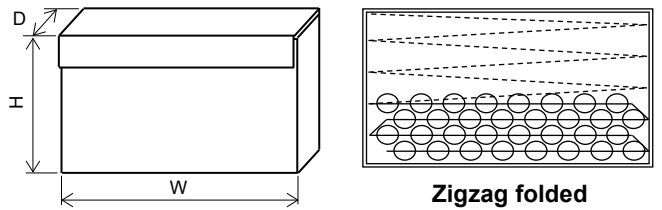

Unit : mm

Size code	W	H	D
F	340 max.	230 max.	55 max.
G	340 max.	170 max.	55 max.
G12	340 max.	170 max.	55 max.
G16	340 max.	170 max.	55 max.

● Min.packing quantity

Size code	Min.packing quantity (pcs.)
F	1000
G	500
G12	500
G16	500

**Conductive Polymer Hybrid Aluminum Electrolytic Capacitors**  
Surface Mount Type

**ZA series**

**High temperature lead-free reflow**

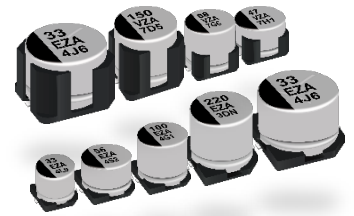

**Features**

- Endurance : 10000 h at 105 °C
- Low ESR and high ripple current (over 70% lower ESR and 100% higher ripple current than V-FP)
- High voltage (to 80 V)
- Characteristics dependencies in frequency and low temperature are as small as polymer type
- Vibration-proof product is available upon request (ø6.3, ø8, ø10)
- AEC-Q200 compliant
- RoHS compliant

**Specifications**

Size code	C	D	D8	F	G
Category temp. range	-55 °C to +105 °C				
Rated voltage range	25 V to 50 V	25 V to 63 V		25 V to 80 V	
Nominal cap.range	10 µF to 33 µF	10 µF to 56 µF	22 µF to 100 µF	22 µF to 220 µF	33 µF to 330 µF
Capacitance tolerance	±20 % (120 Hz / +20 °C)				
Leakage current	$I \leq 0.01 CV$ (µA), 2 minutes after reaching rated voltage, 20 °C *CV = (Capacitance in µF) x (Rated voltage in V)				
Dissipation factor (tan δ)	Please see the attached characteristics list				
Surge voltage (V)	Rated voltage × 1.25 (15 °C to 35 °C)				
Endurance	+105 °C ± 2 °C, 10000 h, apply the rated ripple current without exceeding the rated voltage.				
	Capacitance change	Within ±30% of the initial value			
	Dissipation factor (tan δ)	≤ 200 % of the initial limit			
	ESR	≤ 200 % of the initial limit			
	Leakage current	Within the initial limit			
ESR after endurance (Ω / 100 kHz)(-40 °C)	Size code				
	C	D	D8	F	G
	2.0	1.4	0.8	0.4	0.3
Shelf life	After storage for 1000 hours at +105 °C ± 2 °C with no voltage applied and then being stabilized at +20 °C, capacitors shall meet the limits specified in endurance. (With voltage treatment)				
Damp heat (Load)	+85 °C ± 2 °C, 85 % to 90 %RH, 2000 h, rated voltage applied				
	Capacitance change	Within ±30% of the initial value			
	Dissipation factor (tan δ)	≤ 200 % of the initial limit			
	ESR	≤ 200 % of the initial limit			
	Leakage current	Within the initial limit			
Resistance to soldering heat	After reflow soldering and then being stabilized at +20 °C, capacitors shall meet the following limits.				
	Capacitance change	Within ±10% of the initial value			
	Dissipation factor (tan δ)	Within the initial limit			
	Leakage current	Within the initial limit			

**Marking**

Example : 25 V 33 µF  
Marking color : BLACK

Negative polarity marking (-)

Capacitance (µF)

Series identification

Rated voltage code

Lot number

R. voltage code	Unit : V
E	25
V	35
H	50
J	63
K	80

**Dimensions (not to scale)**

[Standard]

[Vibration-proof product]

< Size code : D, D8 >

< Size code : F, G >

Size code	øD	L	A, B	H <sub>max.</sub>	I	W	P	K	Unit : mm
C	5.0	5.8±0.3	5.3	6.5	2.2	0.65±0.1	1.5	0.35	<sup>+0.15</sup> <sub>-0.20</sub>
D	6.3	5.8±0.3	6.6	7.8	2.6	0.65±0.1	1.8	0.35	<sup>+0.15</sup> <sub>-0.20</sub>
D8	6.3	7.7±0.3	6.6	7.8	2.6	0.65±0.1	1.8	0.35	<sup>+0.15</sup> <sub>-0.20</sub>
F	8.0	10.2±0.3	8.3	10	3.4	0.90±0.2	3.1	0.70±0.2	
G	10.0	10.2±0.3	10.3	12.0	3.5	0.90±0.2	4.6	0.70±0.2	

Size code	øD	L	A, B	H <sub>max.</sub>	F	I	W	P	K	R	S	T	Unit : mm
D	6.3	6.1±0.3	6.6	7.8	0 to +0.15	2.4	0.65±0.1	2.2	0.35	<sup>+0.15</sup> <sub>-0.20</sub>	1.1±0.2	3.3	1.05±0.2
D8	6.3	8.0±0.3	6.6	7.8	0 to +0.15	2.4	0.65±0.1	2.2	0.35	<sup>+0.15</sup> <sub>-0.20</sub>	1.1±0.2	3.3	1.05±0.2
F	8.0	10.5±0.3	8.3	10.0	0 to +0.15	3.4	1.2±0.2	3.1	0.70±0.2	0.70±0.2	5.3	1.3±0.2	
G	10.0	10.5±0.3	10.3	12.0	0 to +0.15	3.5	1.2±0.2	4.6	0.70±0.2	0.70±0.2	6.9	1.3±0.2	

Characteristics list

Endurance : 105 °C 10000 h

Rated voltage (V)	Capacitance (±20 %) (µF)	Case size (mm)			Size code	Specification			Part number		Min. packaging q'ty (pcs)
		øD	L			Ripple current <sup>*1</sup> (mA rms)	ESR <sup>*2</sup> (mΩ)	tan δ <sup>*3</sup>	Standard product	Vibration-proof product	Taping
			Standard	Vibration-proof							
25	22	5.0	5.8	-	C	900	80	0.14	EEHZA1E220R	-	1000
	33	5.0	5.8	-	C	900	80	0.14	EEHZA1E330R	-	1000
	47	6.3	5.8	6.1	D	1300	50	0.14	EEHZA1E470P	EEHZA1E470V	1000
	56	6.3	5.8	6.1	D	1300	50	0.14	EEHZA1E560P	EEHZA1E560V	1000
	68	6.3	7.7	8.0	D8	2000	30	0.14	EEHZA1E680XP	EEHZA1E680XV	900
	100	6.3	7.7	8.0	D8	2000	30	0.14	EEHZA1E101XP	EEHZA1E101XV	900
	150	8.0	10.2	10.5	F	2300	27	0.14	EEHZA1E151P	EEHZA1E151V	500
	220	8.0	10.2	10.5	F	2300	27	0.14	EEHZA1E221P	EEHZA1E221V	500
35	330	10.0	10.2	10.5	G	2500	20	0.14	EEHZA1E331P	EEHZA1E331V	500
	10	5.0	5.8	-	C	900	100	0.12	EEHZA1V100R	-	1000
	22	5.0	5.8	-	C	900	100	0.12	EEHZA1V220R	-	1000
	27	6.3	5.8	6.1	D	1300	60	0.12	EEHZA1V270P	EEHZA1V270V	1000
	33	6.3	5.8	6.1	D	1300	60	0.12	EEHZA1V330P	EEHZA1V330V	1000
	47	6.3	5.8	6.1	D	1300	60	0.12	EEHZA1V470P	EEHZA1V470V	1000
	68	6.3	7.7	8.0	D8	2000	35	0.12	EEHZA1V680XP	EEHZA1V680XV	900
	100	8.0	10.2	10.5	F	2300	27	0.12	EEHZA1V101P	EEHZA1V101V	500
50	150	8.0	10.2	10.5	F	2300	27	0.12	EEHZA1V151P	EEHZA1V151V	500
	220	10.0	10.2	10.5	G	2500	20	0.12	EEHZA1V221P	EEHZA1V221V	500
	270	10.0	10.2	10.5	G	2500	20	0.12	EEHZA1V271P	EEHZA1V271V	500
	10	5.0	5.8	-	C	750	120	0.10	EEHZA1H100R	-	1000
	22	6.3	5.8	6.1	D	1100	80	0.10	EEHZA1H220P	EEHZA1H220V	1000
	33	6.3	7.7	8.0	D8	1600	40	0.10	EEHZA1H330XP	EEHZA1H330XV	900
	47	8.0	10.2	10.5	F	1800	30	0.10	EEHZA1H470P	EEHZA1H470V	500
	68	8.0	10.2	10.5	F	1800	30	0.10	EEHZA1H680P	EEHZA1H680V	500
63	100	10.0	10.2	10.5	G	2000	28	0.10	EEHZA1H101P	EEHZA1H101V	500
	10	6.3	5.8	6.1	D	1000	120	0.08	EEHZA1J100P	EEHZA1J100V	1000
	22	6.3	7.7	8.0	D8	1500	80	0.08	EEHZA1J220XP	EEHZA1J220XV	900
	33	8.0	10.2	10.5	F	1700	40	0.08	EEHZA1J330P	EEHZA1J330V	500
	47	8.0	10.2	10.5	F	1700	40	0.08	EEHZA1J470P	EEHZA1J470V	500
	56	10.0	10.2	10.5	G	1800	30	0.08	EEHZA1J560P	EEHZA1J560V	500
	68	10.0	10.2	10.5	G	1800	30	0.08	EEHZA1J680P	EEHZA1J680V	500
	82	10.0	10.2	10.5	G	1800	30	0.08	EEHZA1J820P	EEHZA1J820V	500
80	22	8.0	10.2	10.5	F	1550	45	0.08	EEHZA1K220P	EEHZA1K220V	500
	33	10.0	10.2	10.5	G	1700	36	0.08	EEHZA1K330P	EEHZA1K330V	500
	47	10.0	10.2	10.5	G	1700	36	0.08	EEHZA1K470P	EEHZA1K470V	500

\*1: Ripple current (100 kHz / +105 °C)

\*2: ESR (100 kHz / +20 °C)

\*3: tan δ (120 Hz / +20 °C)

◆ Please refer to the page of "Reflow profile" and "The taping dimensions".

◆ The dimensions of the vibration-proof products, please refer to the page of the mounting specification.

Frequency correction factor for ripple current

Rated capacitance (C)	Frequency (f)	100 Hz ≤ f < 200 Hz	200 Hz ≤ f < 300 Hz	300 Hz ≤ f < 500 Hz	500 Hz ≤ f < 1 kHz
C < 47 µF	Correction factor	0.10	0.10	0.15	0.20
47 µF ≤ C < 150 µF		0.15	0.20	0.25	0.30
150 µF ≤ C		0.15	0.25	0.25	0.30
Rated capacitance (C)	Frequency (f)	1 kHz ≤ f < 2 kHz	2 kHz ≤ f < 3 kHz	3 kHz ≤ f < 5 kHz	5 kHz ≤ f < 10 kHz
C < 47 µF	Correction factor	0.30	0.40	0.45	0.50
47 µF ≤ C < 150 µF		0.40	0.45	0.55	0.60
150 µF ≤ C		0.45	0.50	0.60	0.65
Rated capacitance (C)	Frequency (f)	10 kHz ≤ f < 15 kHz	15 kHz ≤ f < 20 kHz	20 kHz ≤ f < 30 kHz	30 kHz ≤ f < 40 kHz
C < 47 µF	Correction factor	0.60	0.65	0.70	0.75
47 µF ≤ C < 150 µF		0.70	0.75	0.80	0.80
150 µF ≤ C		0.75	0.80	0.85	0.85
Rated capacitance (C)	Frequency (f)	40 kHz ≤ f < 50 kHz	50 kHz ≤ f < 100 kHz	100 kHz ≤ f < 500 kHz	500 kHz ≤ f
C < 47 µF	Correction factor	0.80	0.85	1.00	1.05
47 µF ≤ C < 150 µF		0.85	0.90	1.00	1.00
150 µF ≤ C		0.85	0.90	1.00	1.00

Design and specifications are each subject to change without notice. Ask factory for the current technical specifications before purchase and/or use.

Should a safety concern arise regarding this product, please be sure to contact us immediately.

**Conductive Polymer Hybrid Aluminum Electrolytic Capacitors**  
Surface Mount Type

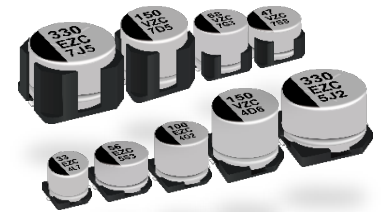

**ZC series**      **High temperature lead-free reflow**

**Features**

- Endurance: 4000 h at 125 °C (High temperature / Long life)
- Low ESR and high ripple current (over 85% lower ESR than V-TP)
- High-withstand voltage (to 80 V)
- Characteristics dependencies in frequency and low temperature are as small as polymer type
- Vibration-proof product is available upon request (ø6.3, ø8, ø10)
- AEC-Q200 compliant
- RoHS compliant

**Specifications**

Size code	C	D	D8	F	G
Category temp. range	-55 °C to +125 °C				
Rated voltage range	25 V to 50 V	25 V to 63 V		25 V to 80 V	
Nominal cap. range	10 µF to 33 µF	10 µF to 56 µF	22 µF to 100 µF	22 µF to 220 µF	33 µF to 330 µF
Capacitance tolerance	±20 % (120 Hz / +20 °C)				
Leakage current	$I \leq 0.01 CV$ (µA), 2 minutes after reaching rated voltage, 20 °C *CV = (Capacitance in µF) x (Rated voltage in V)				
Dissipation factor (tan δ)	Please see the attached characteristics list				
Surge voltage (V)	Rated voltage × 1.25 (15 °C to 35 °C)				
Endurance 1	+125 °C ± 2 °C, 4000 h, apply the rated ripple current without exceeding the rated voltage.				
	Capacitance change	Within ±30% of the initial value			
	Dissipation factor (tan δ)	≤ 200 % of the initial limit			
	ESR	≤ 200 % of the initial limit			
Endurance 2	+125 °C ± 2 °C, 3000 h, apply the rated ripple current without exceeding the rated voltage.				
	Capacitance change	Within ±30% of the initial value			
	Dissipation factor (tan δ)	≤ 200 % of the initial limit			
	ESR	≤ 300 % of the initial limit			
Shelf life	After storage for 1000 hours at +125 °C ± 2 °C with no voltage applied and then being stabilized at +20 °C, capacitors shall meet the limits specified in endurance. (With voltage treatment)				
Damp heat (Load)	+85 °C ± 2 °C, 85 % to 90 %RH, 2000 h, rated voltage applied				
	Capacitance change	Within ±30% of the initial value			
	Dissipation factor (tan δ)	≤ 200 % of the initial limit			
	ESR	≤ 200 % of the initial limit			
Resistance to soldering heat	After reflow soldering and then being stabilized at +20 °C, capacitors shall meet the following limits.				
	Capacitance change	Within ±10% of the initial value			
	Dissipation factor (tan δ)	Within the initial limit			
	Leakage current	Within the initial limit			

**Marking**

Example : 25 V 33 µF  
Marking color : BLACK

Negative polarity marking (-)

Capacitance (µF)

Series identification

Rated voltage code

Lot number

R. voltage code	Unit : V
E	25
V	35
H	50
J	63
K	80

**Dimensions (not to scale)**

[Standard]

Size code	øD	L	A, B	H <sub>max.</sub>	I	W	P	K
C	5.0	5.8±0.3	5.3	6.5	2.2	0.65±0.1	1.5	0.35 <sup>+0.15</sup> <sub>-0.20</sub>
D	6.3	5.8±0.3	6.6	7.8	2.6	0.65±0.1	1.8	0.35 <sup>+0.15</sup> <sub>-0.20</sub>
D8	6.3	7.7±0.3	6.6	7.8	2.6	0.65±0.1	1.8	0.35 <sup>+0.15</sup> <sub>-0.20</sub>
F	8.0	10.2±0.3	8.3	10	3.4	0.90±0.2	3.1	0.70±0.2
G	10.0	10.2±0.3	10.3	12.0	3.5	0.90±0.2	4.6	0.70±0.2

[Vibration-proof product]

< Size code : D, D8 >

Size code	øD	L	A, B	H <sub>max.</sub>	F	I	W	P	K	R	S	T
D	6.3	6.1±0.3	6.6	7.8	0 to +0.15	2.4	0.65±0.1	2.2	0.35 <sup>+0.15</sup> <sub>-0.20</sub>	1.1±0.2	3.3	1.05±0.2
D8	6.3	8.0±0.3	6.6	7.8	0 to +0.15	2.4	0.65±0.1	2.2	0.35 <sup>+0.15</sup> <sub>-0.20</sub>	1.1±0.2	3.3	1.05±0.2
F	8.0	10.5±0.3	8.3	10.0	0 to +0.15	3.4	1.2±0.2	3.1	0.70±0.2	0.70±0.2	5.3	1.3±0.2
G	10.0	10.5±0.3	10.3	12.0	0 to +0.15	3.5	1.2±0.2	4.6	0.70±0.2	0.70±0.2	6.9	1.3±0.2

< Size code : F, G >

**Characteristics list**

Endurance 1 : 125 °C 4000 h

Endurance 2 : 125 °C 3000 h

Rated voltage (V)	Capacitance (±20 %) (µF)	Case size (mm)			Size code	Specification				Part number		Min. packaging qty (pcs)
		øD	L			Ripple current *1 (mA rms)	ESR*2 (mΩ)	tan δ*3	Standard product	Vibration-proof product	Taping	
			Standard	Vibration-proof								Endurance 1
25	22	5.0	5.8	—	C	550	—	80	0.14	EEHZC1E220R	—	1000
	33	5.0	5.8	—	C	550	—	80	0.14	EEHZC1E330R	—	1000
	47	6.3	5.8	6.1	D	900	—	50	0.14	EEHZC1E470P	EEHZC1E470V	1000
	56	6.3	5.8	6.1	D	900	—	50	0.14	EEHZC1E560P	EEHZC1E560V	1000
	68	6.3	7.7	8.0	D8	1400	—	30	0.14	EEHZC1E680XP	EEHZC1E680XV	900
	100	6.3	7.7	8.0	D8	1400	—	30	0.14	EEHZC1E101XP	EEHZC1E101XV	900
	150	8.0	10.2	10.5	F	1600	1900	27	0.14	EEHZC1E151P	EEHZC1E151V	500
	220	8.0	10.2	10.5	F	1600	1900	27	0.14	EEHZC1E221P	EEHZC1E221V	500
35	330	10.0	10.2	10.5	G	2000	2900	20	0.14	EEHZC1E331P	EEHZC1E331V	500
	10	5.0	5.8	—	C	550	—	100	0.12	EEHZC1V100R	—	1000
	22	5.0	5.8	—	C	550	—	100	0.12	EEHZC1V220R	—	1000
	33	6.3	5.8	6.1	D	900	—	60	0.12	EEHZC1V330P	EEHZC1V330V	1000
	47	6.3	5.8	6.1	D	900	—	60	0.12	EEHZC1V470P	EEHZC1V470V	1000
	68	6.3	7.7	8.0	D8	1400	—	35	0.12	EEHZC1V680XP	EEHZC1V680XV	900
	100	8.0	10.2	10.5	F	1600	1900	27	0.12	EEHZC1V101P	EEHZC1V101V	500
	150	8.0	10.2	10.5	F	1600	1900	27	0.12	EEHZC1V151P	EEHZC1V151V	500
50	220	10.0	10.2	10.5	G	2000	2800	20	0.12	EEHZC1V221P	EEHZC1V221V	500
	270	10.0	10.2	10.5	G	2000	2800	20	0.12	EEHZC1V271P	EEHZC1V271V	500
	10	5.0	5.8	—	C	500	—	120	0.10	EEHZC1H100R	—	1000
	22	6.3	5.8	6.1	D	750	—	80	0.10	EEHZC1H220P	EEHZC1H220V	1000
	33	6.3	7.7	8.0	D8	1100	—	40	0.10	EEHZC1H330XP	EEHZC1H330XV	900
	47	8.0	10.2	10.5	F	1250	—	30	0.10	EEHZC1H470P	EEHZC1H470V	500
	68	8.0	10.2	10.5	F	1250	—	30	0.10	EEHZC1H680P	EEHZC1H680V	500
	100	10.0	10.2	10.5	G	1600	—	28	0.10	EEHZC1H101P	EEHZC1H101V	500
63	120	10.0	10.2	10.5	G	1600	—	28	0.10	EEHZC1H121P	EEHZC1H121V	500
	10	6.3	5.8	6.1	D	700	—	120	0.08	EEHZC1J100P	EEHZC1J100V	1000
	22	6.3	7.7	8.0	D8	900	—	80	0.08	EEHZC1J220XP	EEHZC1J220XV	900
	33	8.0	10.2	10.5	F	1100	—	40	0.08	EEHZC1J330P	EEHZC1J330V	500
	47	8.0	10.2	10.5	F	1100	—	40	0.08	EEHZC1J470P	EEHZC1J470V	500
	56	10.0	10.2	10.5	G	1400	—	30	0.08	EEHZC1J560P	EEHZC1J560V	500
	68	10.0	10.2	10.5	G	1400	—	30	0.08	EEHZC1J680P	EEHZC1J680V	500
	82	10.0	10.2	10.5	G	1400	—	30	0.08	EEHZC1J820P	EEHZC1J820V	500
80	22	8.0	10.2	10.5	F	1050	—	45	0.08	EEHZC1K220P	EEHZC1K220V	500
	33	10.0	10.2	10.5	G	1360	—	36	0.08	EEHZC1K330P	EEHZC1K330V	500
	47	10.0	10.2	10.5	G	1360	—	36	0.08	EEHZC1K470P	EEHZC1K470V	500

\*1: Ripple current (100 kHz / +125 °C)

\*2: ESR (100 kHz / +20 °C)

\*3: tan δ (120 Hz / +20 °C)

◆ Please refer to the page of "Reflow profile" and "The taping dimensions".

◆ The dimensions of the vibration-proof products, please refer to the page of the mounting specification.

**Frequency correction factor for ripple current**

Rated capacitance (C)	Frequency (f)	100 Hz ≤ f < 200 Hz	200 Hz ≤ f < 300 Hz	300 Hz ≤ f < 500 Hz	500 Hz ≤ f < 1 kHz
C < 47 µF	Correction factor	0.10	0.10	0.15	0.20
47 µF ≤ C < 150 µF		0.15	0.20	0.25	0.30
150 µF ≤ C		0.15	0.25	0.25	0.30
Rated capacitance (C)	Frequency (f)	1 kHz ≤ f < 2 kHz	2 kHz ≤ f < 3 kHz	3 kHz ≤ f < 5 kHz	5 kHz ≤ f < 10 kHz
C < 47 µF	Correction factor	0.30	0.40	0.45	0.50
47 µF ≤ C < 150 µF		0.40	0.45	0.55	0.60
150 µF ≤ C		0.45	0.50	0.60	0.65
Rated capacitance (C)	Frequency (f)	10 kHz ≤ f < 15 kHz	15 kHz ≤ f < 20 kHz	20 kHz ≤ f < 30 kHz	30 kHz ≤ f < 40 kHz
C < 47 µF	Correction factor	0.60	0.65	0.70	0.75
47 µF ≤ C < 150 µF		0.70	0.75	0.80	0.80
150 µF ≤ C		0.75	0.80	0.85	0.85
Rated capacitance (C)	Frequency (f)	40 kHz ≤ f < 50 kHz	50 kHz ≤ f < 100 kHz	100 kHz ≤ f < 500 kHz	500 kHz ≤ f
C < 47 µF	Correction factor	0.80	0.85	1.00	1.05
47 µF ≤ C < 150 µF		0.85	0.90	1.00	1.00
150 µF ≤ C		0.85	0.90	1.00	1.00

**After endurance ESR (100 kHz, -40°C)**

Size code	C	D	D8	F	G
ESR (Ω)	2	1.4	0.8	0.4	0.3



**Conductive Polymer Hybrid Aluminum Electrolytic Capacitors**  
Surface Mount Type

**ZK series**

**High temperature lead-free reflow**

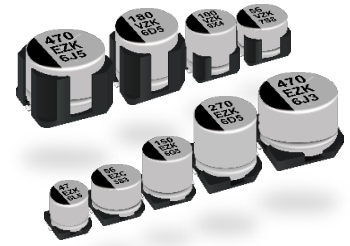

**Features**

- High capacitance and High ripple current compared with ZC series
- Endurance : 4000 h at 125 °C (High temperature / Long life)
- Low ESR
- Characteristics dependencies in frequency and low temperature are as small as polymer type
- Vibration-proof product is available upon request (ø6.3, ø8, ø10)
- AEC-Q200 compliant
- RoHS compliant

**Specifications**

Size code	C	D	D8	F	G
Category temp. range	-55 °C to +125 °C				
Rated voltage range	25 V to 35 V				
Nominal cap.range	33 µF to 47 µF	56 µF to 82 µF	100 µF to 150 µF	180 µF to 270 µF	330 µF to 470 µF
Capacitance tolerance	±20 % (120 Hz / +20 °C)				
Leakage current	I ≤ 0.01 CV (µA), 2 minutes after reaching rated voltage, 20 °C *CV = (Capacitance in µF) x (Rated voltage in V)				
Dissipation factor (tan δ)	Please see the attached characteristics list				
Surge voltage (V)	Rated voltage × 1.25 (15 °C to 35 °C)				
Endurance	+125 °C ± 2 °C, 4000 h, apply the rated ripple current without exceeding the rated voltage.				
	Capacitance change	Within ±30% of the initial value			
	Dissipation factor (tan δ)	≤ 200 % of the initial limit			
	ESR	≤ 200 % of the initial limit			
	Leakage current	Within the initial limit			
ESR after endurance (Q / 100 kHz)(-40 °C)	Size code				
	C	D	D8	F	G
Shelf life	After storage for 1000 hours at +125 °C ± 2 °C with no voltage applied and then being stabilized at +20 °C, capacitors shall meet the limits specified in endurance. (With voltage treatment)				
Damp heat (Load)	+85 °C ± 2 °C, 85 % to 90 %RH, 2000 h, rated voltage applied				
	Capacitance change	Within ±30% of the initial value			
	Dissipation factor (tan δ)	≤ 200 % of the initial limit			
	ESR	≤ 200 % of the initial limit			
	Leakage current	Within the initial limit			
Resistance to soldering heat	After reflow soldering and then being stabilized at +20 °C, capacitors shall meet the following limits.				
	Capacitance change	Within ±10% of the initial value			
	Dissipation factor (tan δ)	Within the initial limit			
	Leakage current	Within the initial limit			

**Marking**

Example : 25 V 47 µF  
Marking color : BLACK

Negative polarity marking (-)

Capacitance (µF)

Series identification

Rated voltage code

Lot number

R. voltage code	Unit : V
E	25
V	35

**Dimensions (not to scale)**

[Standard]

Size code	øD	L	A, B	H max.	I	W	P	K
C	5.0	5.8±0.3	5.3	6.5	2.2	0.65±0.1	1.5	0.35 <sup>+0.15</sup> <sub>-0.20</sub>
D	6.3	5.8±0.3	6.6	7.8	2.6	0.65±0.1	1.8	0.35 <sup>+0.15</sup> <sub>-0.20</sub>
D8	6.3	7.7±0.3	6.6	7.8	2.6	0.65±0.1	1.8	0.35 <sup>+0.15</sup> <sub>-0.20</sub>
F	8.0	10.2±0.3	8.3	10	3.4	0.90±0.2	3.1	0.70±0.2
G	10.0	10.2±0.3	10.3	12.0	3.5	0.90±0.2	4.6	0.70±0.2

[Vibration-proof product]

< Size code : D, D8 >

< Size code : F, G >

Size code	øD	L	A, B	H max.	F	I	W	P	K	R	S	T
D	6.3	6.1±0.3	6.6	7.8	0 to +0.15	2.4	0.65±0.1	2.2	0.35 <sup>+0.15</sup> <sub>-0.20</sub>	1.1±0.2	3.3	1.05±0.2
D8	6.3	8.0±0.3	6.6	7.8	0 to +0.15	2.4	0.65±0.1	2.2	0.35 <sup>+0.15</sup> <sub>-0.20</sub>	1.1±0.2	3.3	1.05±0.2
F	8.0	10.5±0.3	8.3	10.0	0 to +0.15	3.4	1.2±0.2	3.1	0.70±0.2	0.70±0.2	5.3	1.3±0.2
G	10.0	10.5±0.3	10.3	12.0	0 to +0.15	3.5	1.2±0.2	4.6	0.70±0.2	0.70±0.2	6.9	1.3±0.2

**Characteristics list**

Endurance : 125 °C 4000 h

Rated voltage (V)	Capacitance (±20 %) (µF)	Case size (mm)			Size code	Specification			Part number		Min. packaging q'ty (pcs)
		øD	L			Ripple current*1 (mA rms)	ESR*2 (mΩ)	tan δ*3	Standard product	Vibration-proof product	Taping
			Standard	Vibration-proof							
25	47	5.0	5.8	—	C	850	80	0.14	EEHZK1E470R	—	1000
	68	6.3	5.8	6.1	D	1300	50	0.14	EEHZK1E680P	EEHZK1E680V	1000
	82	6.3	5.8	6.1	D	1300	50	0.14	EEHZK1E820P	EEHZK1E820V	1000
	150	6.3	7.7	8.0	D8	1800	30	0.14	EEHZK1E151XP	EEHZK1E151XV	900
	270	8.0	10.2	10.5	F	2000	27	0.14	EEHZK1E271P	EEHZK1E271V	500
	470	10.0	10.2	10.5	G	2800	20	0.14	EEHZK1E471P	EEHZK1E471V	500
35	33	5.0	5.8	—	C	750	100	0.12	EEHZK1V330R	—	1000
	56	6.3	5.8	6.1	D	1200	60	0.12	EEHZK1V560P	EEHZK1V560V	1000
	100	6.3	7.7	8.0	D8	1700	35	0.12	EEHZK1V101XP	EEHZK1V101XV	900
	180	8.0	10.2	10.5	F	2000	27	0.12	EEHZK1V181P	EEHZK1V181V	500
	330	10.0	10.2	10.5	G	2800	20	0.12	EEHZK1V331P	EEHZK1V331V	500

\*1: Ripple current (100 kHz / +125 °C)

\*2: ESR (100 kHz / +20 °C)

\*3: tan δ (120 Hz / +20 °C)

◆ Please refer to the page of "Reflow profile" and "The taping dimensions".

◆ The dimensions of the vibration-proof products, please refer to the page of the mounting specification.

**Frequency correction factor for ripple current**

Rated capacitance (C)	Frequency (f)	100 Hz ≤ f < 200 Hz	200 Hz ≤ f < 300 Hz	300 Hz ≤ f < 500 Hz	500 Hz ≤ f < 1 kHz
C < 47 µF	Correction factor	0.15	0.20	0.25	0.35
47 µF ≤ C < 100 µF		0.15	0.25	0.30	0.40
100 µF ≤ C		0.15	0.25	0.30	0.40
Rated capacitance (C)	Frequency (f)	1 kHz ≤ f < 2 kHz	2 kHz ≤ f < 3 kHz	3 kHz ≤ f < 5 kHz	5 kHz ≤ f < 10 kHz
C < 47 µF	Correction factor	0.45	0.55	0.60	0.65
47 µF ≤ C < 100 µF		0.50	0.60	0.65	0.70
100 µF ≤ C		0.50	0.60	0.65	0.70
Rated capacitance (C)	Frequency (f)	10 kHz ≤ f < 15 kHz	15 kHz ≤ f < 20 kHz	20 kHz ≤ f < 30 kHz	30 kHz ≤ f < 40 kHz
C < 47 µF	Correction factor	0.70	0.75	0.75	0.75
47 µF ≤ C < 100 µF		0.75	0.75	0.80	0.80
100 µF ≤ C		0.75	0.80	0.85	0.85
Rated capacitance (C)	Frequency (f)	40 kHz ≤ f < 50 kHz	50 kHz ≤ f < 100 kHz	100 kHz ≤ f < 500 kHz	500 kHz ≤ f
C < 47 µF	Correction factor	0.80	0.85	1.00	1.05
47 µF ≤ C < 100 µF		0.85	0.90	1.00	1.00
100 µF ≤ C		0.85	0.90	1.00	1.00

**Conductive Polymer Hybrid Aluminum Electrolytic Capacitors**  
Surface Mount Type

**ZKU series High temperature lead-free reflow**

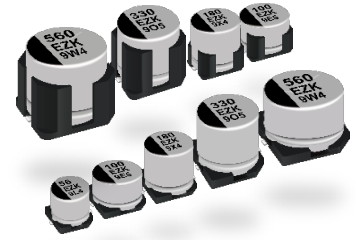

**Features**

- Endurance : 4000 h at 125 °C (High temperature / Long life)
- Large capacitance compared with ZK series
- Low ESR
- Characteristics dependencies in frequency and low temperature are as small as polymer type
- Vibration-proof product is available upon request. (ø6.3, ø8, ø10)
- AEC-Q200 compliant
- RoHS compliant

**Specifications**

Size code	C	D	D8	F	G
Category temp. range	-55 °C to +125 °C				
Rated voltage range	25 V to 35 V				
Nominal cap.range	39 µF to 56 µF	68 µF to 100 µF	120 µF to 180 µF	220 µF to 330 µF	390 µF to 560 µF
Capacitance tolerance	±20 % (120 Hz / +20 °C)				
Leakage current	I ≤ 0.01 CV (µA), 2 minutes after reaching rated voltage, 20 °C *CV = (Capacitance in µF) x (Rated voltage in V)				
Dissipation factor (tan δ)	Please see the attached characteristics list				
Surge voltage (V)	Rated voltage × 1.25 (15 °C to 35 °C)				
Endurance	+125 °C ± 2 °C 4000 h, apply the rated ripple current without exceeding the rated voltage.				
	Capacitance change	Within ±30% of the initial value			
	Dissipation factor (tan δ)	≤ 200 % of the initial limit			
	ESR	≤ 200 % of the initial limit			
	Leakage current	Within the initial limit			
ESR after endurance (Ω / 100 kHz)(-40 °C)	Size code				
	C	D	D8	F	G
	2.0	1.4	0.8	0.4	0.3
Shelf life	After storage for 1000 hours at +125 °C ± 2 °C with no voltage applied and then being stabilized at +20 °C, capacitors shall meet the limits specified in endurance. (With voltage treatment)				
Damp heat (Load)	+85 °C ± 2 °C, 85 % to 90 %RH, 2000 h, rated voltage applied				
	Capacitance change	Within ±30% of the initial value			
	Dissipation factor (tan δ)	≤ 200 % of the initial limit			
	ESR	≤ 200 % of the initial limit			
Leakage current	Within the initial limit				

**Marking**

Example : 25 V 56 µF  
Marking color : BLACK

Negative polarity marking (-)  
Capacitance (µF)  
Series identification  
Rated voltage code  
Lot number

R. voltage code	Unit : V
E	25
V	35

**Dimensions (not to scale)**

[Standard]

Size code	øD	L	A, B	H <sub>max.</sub>	I	W	P	K
C	5.0	5.8±0.3	5.3	6.5	2.2	0.65±0.1	1.5	0.35 <sup>+0.15</sup> <sub>-0.20</sub>
D	6.3	5.8±0.3	6.6	7.8	2.6	0.65±0.1	1.8	0.35 <sup>+0.15</sup> <sub>-0.20</sub>
D8	6.3	7.7±0.3	6.6	7.8	2.6	0.65±0.1	1.8	0.35 <sup>+0.15</sup> <sub>-0.20</sub>
F	8.0	10.2±0.3	8.3	10	3.4	0.90±0.2	3.1	0.70±0.2
G	10.0	10.2±0.3	10.3	12.0	3.5	0.90±0.2	4.6	0.70±0.2

[Vibration-proof product]  
< Size code : D, D8 >

< Size code : F, G >

Size code	øD	L	A, B	H <sub>max.</sub>	F	I	W	P	K	R	S	T
D	6.3	6.1±0.3	6.6	7.8	0 to +0.15	2.4	0.65±0.1	2.2	0.35 <sup>+0.15</sup> <sub>-0.20</sub>	1.1±0.2	3.3	1.05±0.2
D8	6.3	8.0±0.3	6.6	7.8	0 to +0.15	2.4	0.65±0.1	2.2	0.35 <sup>+0.15</sup> <sub>-0.20</sub>	1.1±0.2	3.3	1.05±0.2
F	8.0	10.5±0.3	8.3	10.0	0 to +0.15	3.4	1.2±0.2	3.1	0.70±0.2	0.70±0.2	5.3	1.3±0.2
G	10.0	10.5±0.3	10.3	12.0	0 to +0.15	3.5	1.2±0.2	4.6	0.70±0.2	0.70±0.2	6.9	1.3±0.2

## Characteristics list

Endurance : 125 °C 4000 h

Rated voltage (V)	Capacitance (±20 %) (μF)	Case size (mm)			Size code	Specification			Part number		Min. packaging q'ty (pcs)
		øD	L			Ripple current* <sup>1</sup> (mA rms)	ESR* <sup>2</sup> (mΩ)	tan δ* <sup>3</sup>	Standard product	Vibration-proof product	Taping
			Standard	Vibration-proof							
25	56	5	5.8	-	C	850	80	0.14	EEHZK1E560UR	-	1000
	100	6.3	5.8	6.1	D	1300	50	0.14	EEHZK1E101UP	EEHZK1E101UV	1000
	180	6.3	7.7	8.0	D8	1800	30	0.14	EEHZKE181XUP	EEHZKE181XUV	900
	330	8	10.2	10.5	F	2000	27	0.14	EEHZK1E331UP	EEHZK1E331UV	500
	560	10	10.2	10.5	G	2800	20	0.14	EEHZK1E561UP	EEHZK1E561UV	500
35	39	5	5.8	-	C	750	100	0.12	EEHZK1V390UR	-	1000
	68	6.3	5.8	6.1	D	1200	60	0.12	EEHZK1V680UP	EEHZK1V680UV	1000
	120	6.3	7.7	8.0	D8	1700	35	0.12	EEHZKV121XUP	EEHZKV121XUV	900
	220	8	10.2	10.5	F	2000	27	0.12	EEHZK1V221UP	EEHZK1V221UV	500
	390	10	10.2	10.5	G	2800	20	0.12	EEHZK1V391UP	EEHZK1V391UV	500

\*1: Ripple current (100 kHz / +125 °C)

\*2: ESR (100 kHz / +20 °C)

\*3: tan δ (120 Hz / +20 °C)

◆ Please refer to the page of "Reflow profile" and "The taping dimensions".

◆ The dimensions of the vibration-proof products, please refer to the page of the mounting specification.

## Frequency correction factor for ripple current

Rated capacitance (C)	Frequency(f)	100 Hz ≤ f < 200 Hz	200 Hz ≤ f < 300 Hz	300 Hz ≤ f < 500 Hz	500 Hz ≤ f < 1 kHz
C < 47 μF	Correction factor	0.15	0.20	0.25	0.35
47 μF ≤ C < 100 μF		0.15	0.25	0.30	0.40
100 μF ≤ C		0.15	0.25	0.30	0.40

Rated capacitance (C)	Frequency(f)	1 kHz ≤ f < 2 kHz	2 kHz ≤ f < 3 kHz	3 kHz ≤ f < 5 kHz	5 kHz ≤ f < 10 kHz
C < 47 μF	Correction factor	0.45	0.55	0.60	0.65
47 μF ≤ C < 100 μF		0.50	0.60	0.65	0.70
100 μF ≤ C		0.50	0.60	0.65	0.70

Rated capacitance (C)	Frequency(f)	10 kHz ≤ f < 15 kHz	15 kHz ≤ f < 20 kHz	20 kHz ≤ f < 30 kHz	30 kHz ≤ f < 40 kHz
C < 47 μF	Correction factor	0.70	0.75	0.75	0.75
47 μF ≤ C < 100 μF		0.75	0.75	0.80	0.80
100 μF ≤ C		0.75	0.80	0.85	0.85

Rated capacitance (C)	Frequency(f)	40 kHz ≤ f < 50 kHz	50 kHz ≤ f < 100 kHz	100 kHz ≤ f < 500 kHz	500 kHz ≤ f
C < 47 μF	Correction factor	0.80	0.85	1.00	1.05
47 μF ≤ C < 100 μF		0.85	0.90	1.00	1.00
100 μF ≤ C		0.85	0.90	1.00	1.00

**Conductive Polymer Hybrid Aluminum Electrolytic Capacitors**  
Surface Mount Type

**ZL series High temperature lead-free reflow**

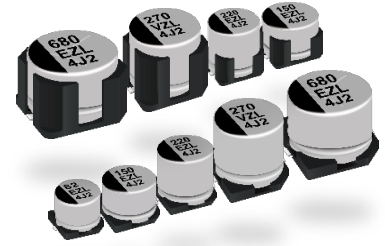

**Features**

- Endurance : 4000 h at 125 °C /135 °C
- Higher capacitance (max 150 % of ZKU series)
- AEC-Q200 compliant
- Smaller than ZC series with the same capacitance
- Low ESR (max 40 %, lower ESR than ZC or ZKU series)
- RoHS compliant

**Specifications**

Size code	C	D	D8	F	G
Category temp. range	-55 °C to +135 °C				
Rated voltage range	25 V to 35 V				
Nominal cap.range	47 μF to 82 μF	82 μF to 150 μF	150 μF to 220 μF	270 μF to 470 μF	470 μF to 680 μF
Capacitance tolerance	±20 % (120 Hz / +20 °C)				
Leakage current	I ≤ 0.01 CV (μA), 2 minutes after reaching rated voltage, 20 °C *CV = (Capacitance in μF) x (Rated voltage in V)				
Dissipation factor (tan δ)	Please see the attached characteristics list				
Surge voltage (V)	Rated voltage × 1.25 (15 °C to 35 °C)				
Endurance 1	+125 °C ± 2 °C 4000 h, apply the rated ripple current without exceeding the rated voltage.				
	Capacitance change	Within ±30% of the initial value			
	Dissipation factor (tan δ)	≤ 200 % of the initial limit			
	ESR	≤ 200 % of the initial limit			
	Leakage current	Within the initial limit			
Endurance 2	+135 °C ± 2 °C 2000 h (C,D,D8 size) or 4000 h (F,G size), apply the rated ripple current without exceeding the rated voltage.				
	Capacitance change	Within ±30% of the initial value			
	Dissipation factor (tan δ)	≤ 200 % of the initial limit			
	ESR	≤ 200 % of the initial limit			
	Leakage current	Within the initial limit			
Shelf life	After storage for 1000 hours at +135 °C ± 2 °C with no voltage applied and then being stabilized at +20 °C, capacitors shall meet the limits specified in endurance. (With voltage treatment)				
	+85 °C ± 2 °C, 85 % to 90 %RH, 2000 h, rated voltage applied				
	Capacitance change	Within ±30% of the initial value			
	Dissipation factor (tan δ)	≤ 200 % of the initial limit			
	ESR	≤ 200 % of the initial limit			
Damp heat (Load)	After reflow soldering and then being stabilized at +20 °C, capacitors shall meet the following limits.				
	Capacitance change	Within ±10 % of the initial value			
	Dissipation factor (tan δ)	Within the initial limit			
	Leakage current	Within the initial limit			
	Resistance to soldering heat	Within the initial limit			

**Marking**

Example : 25 V 470 μF  
Marking color : BLACK

Negative polarity marking (-)  
Capacitance (μF)  
Series identification  
Rated voltage code  
Lot number

R. voltage code	Unit : V
E	25
V	35

**Dimensions (not to scale)**

[Standard]

Size code	øD	L	A, B	H <sub>max.</sub>	I	W	P	K
C	5.0	5.8±0.3	5.3	6.5	2.2	0.65±0.1	1.5	0.35 <sup>+0.15/-0.20</sup>
D	6.3	5.8±0.3	6.6	7.8	2.6	0.65±0.1	1.8	0.35 <sup>+0.15/-0.20</sup>
D8	6.3	7.7±0.3	6.6	7.8	2.6	0.65±0.1	1.8	0.35 <sup>+0.15/-0.20</sup>
F	8.0	10.2±0.3	8.3	10	3.4	0.90±0.2	3.1	0.70±0.2
G	10.0	10.2±0.3	10.3	12.0	3.5	0.90±0.2	4.6	0.70±0.2

[Vibration-proof product]  
< Size code : D, D8 >

Size code	øD	L	A, B	H <sub>max.</sub>	F	I	W	P	K	R	S	T
D	6.3	6.1±0.3	6.6	7.8	0 to +0.15	2.4	0.65±0.1	2.2	0.35 <sup>+0.15/-0.20</sup>	1.1±0.2	3.3	1.05±0.2
D8	6.3	8.0±0.3	6.6	7.8	0 to +0.15	2.4	0.65±0.1	2.2	0.35 <sup>+0.15/-0.20</sup>	1.1±0.2	3.3	1.05±0.2
F	8.0	10.5±0.3	8.3	10.0	0 to +0.15	3.4	1.2±0.2	3.1	0.70±0.2	0.70±0.2	5.3	1.3±0.2
G	10.0	10.5±0.3	10.3	12.0	0 to +0.15	3.5	1.2±0.2	4.6	0.70±0.2	0.70±0.2	6.9	1.3±0.2

< Size code : F, G >

## Characteristics list

Endurance 1 : 125 °C 4000 h

Endurance 2 : 135 °C 2000 h (C, D, D8 size) / 4000 h (F, G size)

Rated voltage (V)	Capacitance (±20 %) (μF)	Case size (mm)			Size code	Specification				Part number		Min. packaging q'ty (pcs)
		øD	L			Ripple current <sup>*1</sup> (mA rms)	ESR <sup>*2</sup> (mΩ)	tan δ <sup>*3</sup>	Standard product	Vibration-proof product	Taping	
			Standard	Vibration-proof								Endurance 1 (+125°C)
25	82	5.0	5.8	-	C	1000	600	58	0.14	EEHZL1E820R	-	1000
	150	6.3	5.8	6.1	D	1500	800	38	0.14	EEHZL1E151P	EEHZL1E151V	1000
	220	6.3	7.7	8.0	D8	2000	1000	24	0.14	EEHZL1E221XP	EEHZL1E221XV	900
	470	8.0	10.2	10.5	F	3000	2000	18	0.14	EEHZL1E471P	EEHZL1E471V	500
	680	10.0	10.2	10.5	G	3400	2300	14	0.14	EEHZL1E681P	EEHZL1E681V	500
35	47	5.0	5.8	-	C	900	550	60	0.12	EEHZL1V470R	-	1000
	82	6.3	5.8	6.1	D	1400	700	40	0.12	EEHZL1V820P	EEHZL1V820V	1000
	150	6.3	7.7	8.0	D8	1900	900	26	0.12	EEHZL1V151XP	EEHZL1V151XV	900
	270	8.0	10.2	10.5	F	2900	1900	20	0.12	EEHZL1V271P	EEHZL1V271V	500
	470	10.0	10.2	10.5	G	3300	2200	16	0.12	EEHZL1V471P	EEHZL1V471V	500

\*1: Ripple current (100 kHz / +125 °C or +135 °C)

\*2: ESR (100 kHz / +20 °C)

\*3: tan δ (120 Hz / +20 °C)

◆ Please refer to the page of "Reflow profile" and "The taping dimensions".

## Frequency correction factor for ripple current

Rated capacitance (C)	Frequency(f)	100 Hz ≤ f < 200 Hz	200 Hz ≤ f < 300 Hz	300 Hz ≤ f < 500 Hz	500 Hz ≤ f < 1 kHz
47 μF ≤ C < 150 μF	Correction factor	0.15	0.20	0.25	0.30
150 μF ≤ C		0.15	0.25	0.25	0.30
Rated capacitance (C)	Frequency(f)	1 kHz ≤ f < 2 kHz	2 kHz ≤ f < 3 kHz	3 kHz ≤ f < 5 kHz	5 kHz ≤ f < 10 kHz
47 μF ≤ C < 150 μF	Correction factor	0.40	0.45	0.55	0.60
150 μF ≤ C		0.45	0.50	0.60	0.65
Rated capacitance (C)	Frequency(f)	10 kHz ≤ f < 15 kHz	15 kHz ≤ f < 20 kHz	20 kHz ≤ f < 30 kHz	30 kHz ≤ f < 40 kHz
47 μF ≤ C < 150 μF	Correction factor	0.70	0.75	0.80	0.80
150 μF ≤ C		0.75	0.80	0.85	0.85
Rated capacitance (C)	Frequency(f)	40 kHz ≤ f < 50 kHz	50 kHz ≤ f < 100 kHz	100 kHz ≤ f < 500 kHz	500 kHz ≤ 1000 kHz
47 μF ≤ C < 150 μF	Correction factor	0.85	0.90	1.00	1.00
150 μF ≤ C		0.85	0.90	1.00	1.00

**Conductive Polymer Hybrid Aluminum  
Electrolytic Capacitors**  
Surface Mount Type

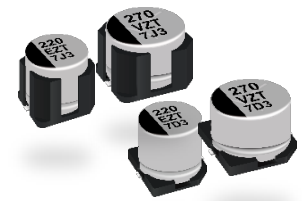

**ZT series**      **High temperature lead-free reflow**

**Features**

- Endurance: 4000 h at 125 °C
- Higher ripple current (75 % to 118 % higher than ZC series)
- Vibration-proof product is available upon request.
- AEC-Q200 compliant
- RoHS compliant

**Specifications**

Size code	F	G
Category temp. range	-55 °C to +125 °C	
Rated voltage range	25 V to 63 V	
Nominal cap. range	33 µF to 220 µF	56 µF to 330 µF
Capacitance tolerance	±20 % (120 Hz / +20 °C)	
Leakage current	I ≤ 0.01 CV (µA), 2 minutes after reaching rated voltage, 20 °C *CV = (Capacitance in µF) x (Rated voltage in V)	
Dissipation factor (tan δ)	Please see the attached characteristics list	
Surge voltage (V)	Rated voltage × 1.25 (15 °C to 35 °C)	
Endurance	+125 °C ± 2 °C, 4000 h, apply the rated ripple current without exceeding the rated voltage	
	Capacitance change	Within ±30% of the initial value
	Dissipation factor (tan δ)	≤ 200 % of the initial limit
	E.S.R.	≤ 200 % of the initial limit
	Leakage current	Within the initial limit
ESR after endurance (Ω / 100 kHz)(-40 °C)	Size code	
	F	G
	0.4	0.3
Shelf life	After storage for 1000 hours at +125 °C ± 2 °C with no voltage applied and then being stabilized at +20 °C, capacitors shall meet the limits specified in endurance. (With voltage treatment)	
Damp heat (Load)	85 °C ± 2 °C, 85 % to 90 %RH, 2000 h, rated voltage applied	
	Capacitance change	Within ±30% of the initial value
	Dissipation factor (tan δ)	≤ 200 % of the initial limit
	E.S.R.	≤ 200 % of the initial limit
Leakage current	Within the initial limit	
Resistance to soldering heat	After reflow soldering and then being stabilized at +20 °C, capacitors shall meet the following limits.	
	Capacitance change	Within ±10% of the initial value
	Dissipation factor (tan δ)	Within the initial limit
Leakage current	Within the initial limit	

**Marking**

Example : 25 V 220 µF  
Marking color : BLACK

Negative polarity marking (-)  
Capacitance (µF)  
Series identification  
Rated voltage code  
Lot number

R. voltage code	Unit : V
E	25
V	35
H	50
J	63

**Dimensions (not to scale)**

[Standard]

Size code	øD	L	A, B	H max.	I	W	P	K
F	8.0	10.2±0.3	8.3	10.0	3.4	0.90±0.2	3.1	0.70±0.2
G	10.0	10.2±0.3	10.3	12.0	3.5	0.90±0.2	4.6	0.70±0.2

[Vibration-proof product]

Size code	øD	L	A, B	H max.	F	I	W	P	K	R	S	T
F	8.0	10.5±0.3	8.3	10.0	0 to +0.15	3.4	1.2±0.2	3.1	0.70±0.2	0.70±0.2	5.3	1.3±0.2
G	10.0	10.5±0.3	10.3	12.0	0 to +0.15	3.5	1.2±0.2	4.6	0.70±0.2	0.70±0.2	6.9	1.3±0.2

## Characteristics list

Endurance : 125 °C 4000 h

Rated voltage (V)	Capacitance (±20 %) (µF)	Case size (mm)			Size code	Specification			Part number		Min. packaging q'ty (pcs)
		øD	L			Ripple current <sup>*1</sup> (mA rms)	ESR <sup>*2</sup> (mΩ)	tan δ <sup>*3</sup>	Standard product	Vibration-proof product	Taping
			Standard	Vibration-proof							
25	220	8.0	10.2	10.5	F	2900	22	0.14	EEHZT1E221P	EEHZT1E221V	500
	330	10.0	10.2	10.5	G	3500	16	0.14	EEHZT1E331P	EEHZT1E331V	500
35	150	8.0	10.2	10.5	F	2900	22	0.12	EEHZT1V151P	EEHZT1V151V	500
	270	10.0	10.2	10.5	G	3500	16	0.12	EEHZT1V271P	EEHZT1V271V	500
50	68	8.0	10.2	10.5	F	2700	25	0.10	EEHZT1H680P	EEHZT1H680V	500
	100	10.0	10.2	10.5	G	2900	23	0.10	EEHZT1H101P	EEHZT1H101V	500
	120	10.0	10.2	10.5	G	2900	23	0.10	EEHZT1H121P	EEHZT1H121V	500
63	33	8.0	10.2	10.5	F	2400	32	0.08	EEHZT1J330P	EEHZT1J330V	500
	47	8.0	10.2	10.5	F	2400	32	0.08	EEHZT1J470P	EEHZT1J470V	500
	56	10.0	10.2	10.5	G	2800	25	0.08	EEHZT1J560P	EEHZT1J560V	500
	68	10.0	10.2	10.5	G	2800	25	0.08	EEHZT1J680P	EEHZT1J680V	500
	82	10.0	10.2	10.5	G	2800	25	0.08	EEHZT1J820P	EEHZT1J820V	500

\*1: Ripple current (100 kHz / +125 °C)

\*2: ESR (100 kHz / +20 °C)

\*3: tan δ (120 Hz / +20 °C)

◆ Please refer to the page of "Reflow profile" and "The taping dimensions".

## Frequency correction factor for ripple current

Rated capacitance (C)	Frequency (f)	100 Hz ≤ f < 200 Hz	200 Hz ≤ f < 300 Hz	300 Hz ≤ f < 500 Hz	500 Hz ≤ f < 1 kHz
C < 47 µF	Correction factor	0.10	0.10	0.15	0.20
47 µF ≤ C < 150 µF		0.15	0.20	0.25	0.30
150 µF ≤ C		0.15	0.25	0.25	0.30

Rated capacitance (C)	Frequency (f)	1 kHz ≤ f < 2 kHz	2 kHz ≤ f < 3 kHz	3 kHz ≤ f < 5 kHz	5 kHz ≤ f < 10 kHz
C < 47 µF	Correction factor	0.30	0.40	0.45	0.50
47 µF ≤ C < 150 µF		0.40	0.45	0.55	0.60
150 µF ≤ C		0.45	0.50	0.60	0.65

Rated capacitance (C)	Frequency (f)	10 kHz ≤ f < 15 kHz	15 kHz ≤ f < 20 kHz	20 kHz ≤ f < 30 kHz	30 kHz ≤ f < 40 kHz
C < 47 µF	Correction factor	0.60	0.65	0.70	0.75
47 µF ≤ C < 150 µF		0.70	0.75	0.80	0.80
150 µF ≤ C		0.75	0.80	0.85	0.85

Rated capacitance (C)	Frequency (f)	40 kHz ≤ f < 50 kHz	50 kHz ≤ f < 100 kHz	100 kHz ≤ f < 500 kHz	500 kHz ≤ f
C < 47 µF	Correction factor	0.80	0.85	1.00	1.05
47 µF ≤ C < 150 µF		0.85	0.90	1.00	1.00
150 µF ≤ C		0.85	0.90	1.00	1.00



**Conductive Polymer Hybrid Aluminum  
Electrolytic Capacitors**  
Surface Mount Type

**ZTU series High temperature lead-free reflow**

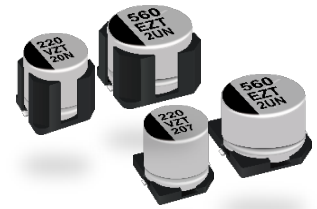

**Features**

- Endurance: 4000 h at 125 °C / 135 °C
- Higher ripple current (max 180 % of ZC series)
- Larger capacitance (max 170 % of ZT series)
- AEC-Q200 compliant
- RoHS compliant

**Specifications**

Size code	F	G
Category temp. range	-55 °C to +135 °C	
Rated voltage range	25 V to 35 V	
Nominal cap.range	220 µF to 330 µF	390 µF to 560 µF
Capacitance tolerance	±20 % (120 Hz / +20 °C)	
Leakage current	I ≤ 0.01 CV (µA), 2 minutes after reaching rated voltage, 20 °C *CV = (Capacitance in µF) x (Rated voltage in V)	
Dissipation factor (tan δ)	Please see the attached characteristics list	
Surge voltage (V)	Rated voltage × 1.25 (15 °C to 35 °C)	
Endurance 1	+125 °C ± 2 °C, 4000 h, apply the rated ripple current without exceeding the rated voltage	
	Capacitance change	Within ±30% of the initial value
	Dissipation factor (tan δ)	≤ 200 % of the initial limit
	E.S.R.	≤ 200 % of the initial limit
	Leakage current	Within the initial limit
Endurance 2	+135 °C ± 2 °C, 4000 h, apply the rated ripple current without exceeding the rated voltage.	
	Capacitance change	Within ±30% of the initial value
	Dissipation factor (tan δ)	≤ 200 % of the initial limit
	E.S.R.	≤ 200 % of the initial limit
	Leakage current	Within the initial limit
Shelf life	After storage for 1000 hours at +135 °C ± 2 °C with no voltage applied and then being stabilized at +20 °C, capacitors shall meet the limits specified in endurance. (With voltage treatment)	
	85 °C ± 2 °C, 85 % to 90 %RH, 2000 h, rated voltage applied	
Damp heat (Load)	Capacitance change	Within ±30% of the initial value
	Dissipation factor (tan δ)	≤ 200 % of the initial limit
	E.S.R.	≤ 200 % of the initial limit
	Leakage current	Within the initial limit
Resistance to soldering heat	After reflow soldering and then being stabilized at +20 °C, capacitors shall meet the following limits.	
	Capacitance change	Within ±10% of the initial value
	Dissipation factor (tan δ)	Within the initial limit
	Leakage current	Within the initial limit

**Marking**

Example : 25 V 330 µF  
Marking color : BLACK

Negative polarity marking (-)  
Capacitance (µF)  
Series identification  
Lot number  
Rated voltage code

R. voltage code	Unit : V
E	25
V	35

**Dimensions (not to scale)**

[Standard]

Size code	øD	L	A, B	H max.	I	W	P	K
F	8.0	10.2±0.3	8.3	10.0	3.4	0.90±0.2	3.1	0.70±0.2
G	10.0	10.2±0.3	10.3	12.0	3.5	0.90±0.2	4.6	0.70±0.2

[Vibration-proof product]

Size code	øD	L	A, B	H max.	F	I	W	P	K	R	S	T
F	8.0	10.5±0.3	8.3	10.0	0 to +0.15	3.4	1.2±0.2	3.1	0.70±0.2	0.70±0.2	5.3	1.3±0.2
G	10.0	10.5±0.3	10.3	12.0	0 to +0.15	3.5	1.2±0.2	4.6	0.70±0.2	0.70±0.2	6.9	1.3±0.2

**Characteristics list**

Endurance 1 : 125 °C 4000 h

Endurance 2 : 135 °C 4000 h

Rated voltage (V)	Capacitance (±20 %) (μF)	Case size (mm)			Size code	Specification				Part number		Min. packaging q'ty (pcs)
		øD	L			Ripple current *1 (mA rms)	ESR *2 (mΩ)	tan δ *3	Standard product	Vibration-proof product	Taping	
			Standard	Vibration-proof								Endurance 1 (+125°C)
25	330	8.0	10.2	10.5	F	2900	1800	22	0.14	EEHZT1E331UP	EEHZT1E331UV	500
	560	10.0	10.2	10.5	G	3500	2200	16	0.14	EEHZT1E561UP	EEHZT1E561UV	500
35	220	8.0	10.2	10.5	F	2900	1800	22	0.12	EEHZT1V221UP	EEHZT1V221UV	500
	390	10.0	10.2	10.5	G	3500	2200	16	0.12	EEHZT1V391UP	EEHZT1V391UV	500

\*1: Ripple current (100 kHz / +125 °C or +135 °C)

\*2: ESR (100 kHz / +20 °C)

\*3: tan δ (120 Hz / +20 °C)

◆ Please refer to the page of "Reflow profile" and "The taping dimensions".

**Frequency correction factor for ripple current**

Rated capacitance (C)	Frequency (f)			
	100 Hz ≤ f < 200 Hz	200 Hz ≤ f < 300 Hz	300 Hz ≤ f < 500 Hz	500 Hz ≤ f < 1 kHz
150 μF ≤ C	0.15	0.25	0.25	0.30

Rated capacitance (C)	Frequency (f)			
	1 kHz ≤ f < 2 kHz	2 kHz ≤ f < 3 kHz	3 kHz ≤ f < 5 kHz	5 kHz ≤ f < 10 kHz
150 μF ≤ C	0.45	0.50	0.60	0.65

Rated capacitance (C)	Frequency (f)			
	10 kHz ≤ f < 15 kHz	15 kHz ≤ f < 20 kHz	20 kHz ≤ f < 30 kHz	30 kHz ≤ f < 40 kHz
150 μF ≤ C	0.75	0.80	0.85	0.85

Rated capacitance (C)	Frequency (f)			
	40 kHz ≤ f < 50 kHz	50 kHz ≤ f < 100 kHz	100 kHz ≤ f < 500 kHz	500 kHz ≤ f < 1000 kHz
150 μF ≤ C	0.85	0.90	1.00	1.00

# Conductive Polymer Hybrid Aluminum Electrolytic Capacitors

## Surface Mount Type

**ZV** series

**High temperature lead-free reflow**

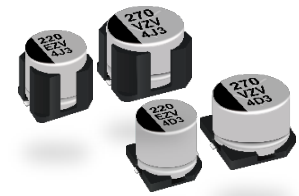

### Features

- Endurance: 4000 h at 125 °C / 135 °C
- Low ESR (up to 39 %, Lower ESR than Current ZT series)
- Higher ripple current (max 150 % of ZT series)
- AEC-Q200 compliant
- RoHS compliant

### Specifications

Size code	F	G
Category temp. range	-55 °C to +135 °C	
Rated voltage range	25 V to 63 V	
Nominal cap.range	33 µF to 220 µF	56 µF to 330 µF
Capacitance tolerance	±20 % (120 Hz / +20 °C)	
Leakage current	I ≤ 0.01 CV (µA), 2 minutes after reaching rated voltage, 20 °C *CV = (Capacitance in µF) x (Rated voltage in V)	
Dissipation factor (tan δ)	Please see the attached characteristics list	
Surge voltage (V)	Rated voltage × 1.25 (15 °C to 35 °C)	
Endurance 1	+125 °C ± 2 °C, 4000 h, apply the rated ripple current without exceeding the rated voltage	
	Capacitance change	Within ±30% of the initial value
	Dissipation factor (tan δ)	≤ 200 % of the initial limit
	E.S.R.	≤ 200 % of the initial limit
	Leakage current	Within the initial limit
ESR after endurance (Ω / 100 kHz)(-40 °C)	Size code	
	F	G
0.4	0.3	
Endurance 2	+135 °C ± 2 °C, 4000 h, apply the rated ripple current without exceeding the rated voltage	
	Capacitance change	Within ±30% of the initial value
	Dissipation factor (tan δ)	≤ 200 % of the initial limit
	E.S.R.	≤ 200 % of the initial limit
	Leakage current	Within the initial limit
ESR after endurance (Ω / 100 kHz)(-40 °C)	Size code	
	F	G
0.4	0.3	
Shelf life	After storage for 1000 hours at +135 °C ± 2 °C with no voltage applied and then being stabilized at +20 °C, capacitors shall meet the limits specified in endurance. (With voltage treatment)	
Damp heat (Load)	85 °C ± 2 °C, 85 % to 90 %RH, 2000 h, rated voltage applied	
	Capacitance change	Within ±30% of the initial value
	Dissipation factor (tan δ)	≤ 200 % of the initial limit
	E.S.R.	≤ 200 % of the initial limit
Leakage current	Within the initial limit	
Resistance to soldering heat	After reflow soldering and then being stabilized at +20 °C, capacitors shall meet the following limits.	
	Capacitance change	Within ±10% of the initial value
	Dissipation factor (tan δ)	Within the initial limit
Leakage current	Within the initial limit	

### Marking

Example : 25 V 330 µF  
Marking color : BLACK

Negative polarity marking (-)  
Capacitance (µF)  
Series identification  
Lot number  
Rated voltage code

R. voltage code	Unit : V
E	25
V	35
H	50
J	63

### Dimensions (not to scale)

[Standard]

Size code	øD	L	A, B	H <sub>max</sub>	I	W	P	K
F	8.0	10.2±0.3	8.3	10.0	3.4	0.90±0.2	3.1	0.70±0.2
G	10.0	10.2±0.3	10.3	12.0	3.5	0.90±0.2	4.6	0.70±0.2

[Vibration-proof product]

Size code	øD	L	A, B	H <sub>max</sub>	F	I	W	P	K	R	S	T
F	8.0	10.5±0.3	8.3	10.0	0 to +0.15	3.4	1.2±0.2	3.1	0.70±0.2	0.70±0.2	5.3	1.3±0.2
G	10.0	10.5±0.3	10.3	12.0	0 to +0.15	3.5	1.2±0.2	4.6	0.70±0.2	0.70±0.2	6.9	1.3±0.2

**Characteristics list**

Endurance 1 : 125 °C 4000 h

Endurance 2 : 135 °C 4000 h

Rated voltage (V)	Capacitance (±20 %) (µF)	Case size (mm)			Size code	Specification				Part number		Min. packaging qty (pcs)
		øD	L			Ripple current <sup>*1</sup> (mA rms)	ESR <sup>*2</sup> (mΩ)	tan δ <sup>*3</sup>	Standard product	Vibration-proof product		
			Standard	Vibration-proof							Endurance 1 (+125°C)	Endurance 2 (+135°C)
25	220	8.0	10.2	10.5	F	3900	2900	16	0.14	EEHZV1E221P	EEHZV1E221V	500
	330	10.0	10.2	10.5	G	4600	3400	12	0.14	EEHZV1E331P	EEHZV1E331V	500
35	150	8.0	10.2	10.5	F	3900	2900	16	0.12	EEHZV1V151P	EEHZV1V151V	500
	270	10.0	10.2	10.5	G	4600	3400	12	0.12	EEHZV1V271P	EEHZV1V271V	500
50	68	8.0	10.2	10.5	F	3600	2500	19	0.10	EEHZV1H680P	EEHZV1H680V	500
	100	10.0	10.2	10.5	G	4300	3200	14	0.10	EEHZV1H101P	EEHZV1H101V	500
	120	10.0	10.2	10.5	G	4300	3200	14	0.10	EEHZV1H121P	EEHZV1H121V	500
63	33	8.0	10.2	10.5	F	3300	2300	22	0.08	EEHZV1J330P	EEHZV1J330V	500
	47	8.0	10.2	10.5	F	3300	2300	22	0.08	EEHZV1J470P	EEHZV1J470V	500
	56	10.0	10.2	10.5	G	4000	3000	16	0.08	EEHZV1J560P	EEHZV1J560V	500
	68	10.0	10.2	10.5	G	4000	3000	16	0.08	EEHZV1J680P	EEHZV1J680V	500
	82	10.0	10.2	10.5	G	4000	3000	16	0.08	EEHZV1J820P	EEHZV1J820V	500

\*1: Ripple current (100 kHz / +125 °C or +135 °C)

\*2: ESR (100 kHz / +20 °C)

\*3: tan δ (120 Hz / +20 °C)

◆ Please refer to the page of "Reflow profile" and "The taping dimensions".

**Frequency correction factor for ripple current**

Rated capacitance (C)	Frequency (f)	100 Hz ≤ f < 200 Hz	200 Hz ≤ f < 300 Hz	300 Hz ≤ f < 500 Hz	500 Hz ≤ f < 1 kHz
C < 47 µF	Correction factor	0.10	0.10	0.15	0.20
47 µF ≤ C < 150 µF		0.15	0.20	0.25	0.30
150 µF ≤ C		0.15	0.25	0.25	0.30

Rated capacitance (C)	Frequency (f)	1 kHz ≤ f < 2 kHz	2 kHz ≤ f < 3 kHz	3 kHz ≤ f < 5 kHz	5 kHz ≤ f < 10 kHz
C < 47 µF	Correction factor	0.30	0.40	0.45	0.50
47 µF ≤ C < 150 µF		0.40	0.45	0.55	0.60
150 µF ≤ C		0.45	0.50	0.60	0.65

Rated capacitance (C)	Frequency (f)	10 kHz ≤ f < 15 kHz	15 kHz ≤ f < 20 kHz	20 kHz ≤ f < 30 kHz	30 kHz ≤ f < 40 kHz
C < 47 µF	Correction factor	0.60	0.65	0.70	0.75
47 µF ≤ C < 150 µF		0.70	0.75	0.80	0.80
150 µF ≤ C		0.75	0.80	0.85	0.85

  

Rated capacitance (C)	Frequency (f)	40 kHz ≤ f < 50 kHz	50 kHz ≤ f < 100 kHz	100 kHz ≤ f < 500 kHz	500 kHz ≤ f < 1000 kHz
C < 47 µF	Correction factor	0.80	0.85	1.00	1.05
47 µF ≤ C < 150 µF		0.85	0.90	1.00	1.00
150 µF ≤ C		0.85	0.90	1.00	1.00

**Conductive Polymer Hybrid Aluminum Electrolytic Capacitors**  
Surface Mount Type

**ZS series**

**High temperature lead-free reflow**

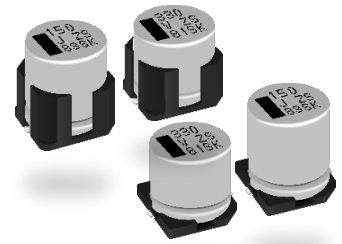

**Features**

- Endurance: 4000 h at 135 °C
- High ripple current and High capacitance
- High-withstand voltage (to 63 V)
- Vibration-proof product is available upon request.
- AEC-Q200 compliant
- RoHS compliant

**Specifications**

Size code	G12	G16
Category temp. range	-55 °C to +135 °C	
Rated voltage range	25 V to 63 V	
Nominal cap.range	100 µF to 470 µF	150 µF to 560 µF
Capacitance tolerance	±20 % (120 Hz / +20 °C)	
Leakage current	$I \leq 0.01 CV$ (µA), 2 minutes after reaching rated voltage, 20 °C *CV = (Capacitance in µF) x (Rated voltage in V)	
Dissipation factor (tan δ)	Please see the attached characteristics list	
Surge voltage (V)	Rated voltage × 1.25 (15 °C to 35 °C)	
Endurance 1	+125 °C ± 2 °C, 4000 h, apply the rated ripple current without exceeding the rated voltage.	
	Capacitance change	Within ±30% of the initial value
	Dissipation factor (tan δ)	≤ 200 % of the initial limit
	E.S.R.	≤ 200 % of the initial limit
Endurance 2	+135 °C ± 2 °C, 4000 h, apply the rated ripple current without exceeding the rated voltage.	
	Capacitance change	Within ±30% of the initial value
	Dissipation factor (tan δ)	≤ 200 % of the initial limit
	E.S.R.	≤ 200 % of the initial limit
Shelf life	After storage for 1000 hours at +135 °C ± 2 °C with no voltage applied and then being stabilized at +20°C, capacitors shall meet the limits specified in endurance. (With voltage treatment)	
Damp heat (Load)	+85 °C ± 2 °C, 85 % to 90 %RH, 2000 h, rated voltage applied.	
	Capacitance change	Within ±30% of the initial value
	Dissipation factor (tan δ)	≤ 200 % of the initial limit
	E.S.R.	≤ 200 % of the initial limit
Resistance to soldering heat	After reflow soldering and then being stabilized at +20°C, capacitors shall meet the following limits.	
	Capacitance change	Within ±10% of the initial value
	Dissipation factor (tan δ)	Within the initial limit
	Leakage current	Within the initial limit

**Marking**

Example : 35 V 470 µF  
Marking color : BLACK

Negative polarity marking (-)

Capacitance (µF)

Series identification

Rated voltage code

Lot number

R. voltage code	Unit : V
E	25
V	35
H	50
J	63

**Dimensions (not to scale)**

**[Standard]**

Size code	øD	L	A, B	H	I	W	P
G12	10.0	12.5	10.3	11.0±0.2	3.2	1.2±0.2	4.6
G16	10.0	16.5	10.3	11.0±0.2	3.2	1.2±0.2	4.6

**[Vibration-proof product]**

Size code	øD	L	A, B	H	F	I	W	P	R	S	T
G12	10.0	12.8	10.3	11.0±0.2	0 to +0.15	3.2	1.2±0.2	4.6	0.70±0.2	6.9	1.3±0.2
G16	10.0	16.8	10.3	11.0±0.2	0 to +0.15	3.2	1.2±0.2	4.6	0.70±0.2	6.9	1.3±0.2

## Characteristics list

Endurance 1 : 125 °C 4000 h

Endurance 2 : 135 °C 4000 h

Rated voltage (V)	Capacitance (±20 %) (μF)	Case size (mm)			Size code	Specification				Part number		Min. packaging q'ty (pcs)	
		øD	L			Ripple current *1 (mA rms)	ESR *2 (mΩ)	tan δ *3	Standard product	Vibration-proof product	Taping		
			Standard	Vibration-proof								Endurance 1 (+125°C)	Endurance 2 (+135°C)
25	470	10.0	12.5	12.8	G12	3500	2500	14	0.14	EEHZS1E471P	EEHZS1E471V	400	
	560	10.0	16.5	16.8	G16	4000	2900	11	0.14	EEHZS1E561P	EEHZS1E561V	250	
35	330	10.0	12.5	12.8	G12	3500	2500	14	0.12	EEHZS1V331P	EEHZS1V331V	400	
	470	10.0	16.5	16.8	G16	4000	2900	11	0.12	EEHZS1V471P	EEHZS1V471V	250	
50	150	10.0	12.5	12.8	G12	3200	2250	17	0.10	EEHZS1H151P	EEHZS1H151V	400	
	220	10.0	16.5	16.8	G16	3700	2600	13	0.10	EEHZS1H221P	EEHZS1H221V	250	
63	100	10.0	12.5	12.8	G12	3000	2100	19	0.08	EEHZS1J101P	EEHZS1J101V	400	
	150	10.0	16.5	16.8	G16	3500	2400	15	0.08	EEHZS1J151P	EEHZS1J151V	250	

\*1: Ripple current (100 kHz / +125 °C or +135 °C)

\*2: ESR (100 kHz / +20 °C)

\*3: tan δ (120 Hz / +20 °C)

◆ Please refer to the page of "Reflow profile" and "The taping dimensions".

## Frequency correction factor for ripple current

Rated capacitance (C)	Frequency (f)	100 Hz ≤ f < 200 Hz	200 Hz ≤ f < 300 Hz	300 Hz ≤ f < 500 Hz	500 Hz ≤ f < 1 kHz
100 μF ≤ C < 150 μF	Correction factor	0.15	0.20	0.25	0.30
		150 μF ≤ C	0.15	0.25	0.25
Rated capacitance (C)	Frequency (f)	1 kHz ≤ f < 2 kHz	2 kHz ≤ f < 3 kHz	3 kHz ≤ f < 5 kHz	5 kHz ≤ f < 10 kHz
100 μF ≤ C < 150 μF	Correction factor	0.40	0.45	0.55	0.60
		150 μF ≤ C	0.45	0.50	0.60
Rated capacitance (C)	Frequency (f)	10 kHz ≤ f < 15 kHz	15 kHz ≤ f < 20 kHz	20 kHz ≤ f < 30 kHz	30 kHz ≤ f < 40 kHz
100 μF ≤ C < 150 μF	Correction factor	0.70	0.75	0.80	0.80
		150 μF ≤ C	0.75	0.80	0.85
Rated capacitance (C)	Frequency (f)	40 kHz ≤ f < 50 kHz	50 kHz ≤ f < 100 kHz	100 kHz ≤ f < 500 kHz	500 kHz ≤ f
100 μF ≤ C < 150 μF	Correction factor	0.85	0.90	1.00	1.00
		150 μF ≤ C	0.85	0.90	1.00

**Conductive Polymer Hybrid Aluminum  
Electrolytic Capacitors**  
Surface Mount Type

**ZSU series High temperature lead-free reflow**

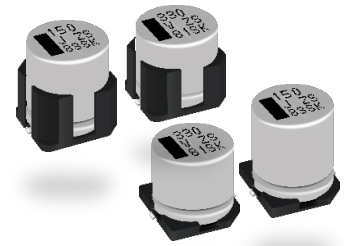

**Features**

- Endurance: 4000 h at 125 °C
- Large capacitance compared with ZS series
- Vibration-proof product is available upon request.
- AEC-Q200 compliant
- RoHS compliant

**Specifications**

Size code	G12		G16	
Category temp. range	-55 °C to +125 °C			
Rated voltage range	25 V to 63 V			
Nominal cap.range	120 µF to 680 µF		180 µF to 1000 µF	
Capacitance tolerance	±20 % (120 Hz / +20 °C)			
Leakage current	I ≤ 0.01 CV (µA), 2 minutes after reaching rated voltage, 20 °C *CV = (Capacitance in µF) x (Rated voltage in V)			
Dissipation factor (tan δ)	Please see the attached characteristics list			
Surge voltage (V)	Rated voltage × 1.25 (15 °C to 35 °C)			
Endurance	+125 °C ± 2 °C, 4000 h, apply the rated ripple current without exceeding the rated voltage.			
	Capacitance change	Within ±30% of the initial value		
	Dissipation factor (tan δ)	≤ 200 % of the initial limit		
	E.S.R.	≤ 200 % of the initial limit		
	Leakage current	Within the initial limit		
ESR after endurance (Ω / 100 kHz)(-40 °C)	Size code			
	G12	G16		
	0.3	0.3		
Shelf life	After storage for 1000 hours at +125 °C ± 2 °C with no voltage applied and then being stabilized at +20°C, capacitors shall meet the limits specified in endurance. (With voltage treatment)			
Damp heat (Load)	+85 °C ± 2 °C, 85 % to 90 %RH, 2000 h, rated voltage applied.			
	Capacitance change	Within ±30% of the initial value		
	Dissipation factor (tan δ)	≤ 200 % of the initial limit		
	E.S.R.	≤ 200 % of the initial limit		
	Leakage current	Within the initial limit		
Resistance to soldering heat	After reflow soldering and then being stabilized at +20°C, capacitors shall meet the following limits.			
	Capacitance change	Within ±10% of the initial value		
	Dissipation factor (tan δ)	Within the initial limit		
	Leakage current	Within the initial limit		

**Marking**

Example : 25 V 680 µF  
Marking color : BLACK

Negative polarity marking (-)

Capacitance (µF)

Series identification

Rated voltage code

Lot number

R. voltage code	Unit : V
E	25
V	35
H	50
J	63

**Dimensions (not to scale)**

**[Standard]**

	Unit : mm							
Size code	øD	L	A, B	H	I	W	P	
G12	10.0	12.5	10.3	11.0±0.2	3.2	1.2±0.2	4.6	
G16	10.0	16.5	10.3	11.0±0.2	3.2	1.2±0.2	4.6	

**[Vibration-proof product]**

	Unit : mm											
Size code	øD	L	A, B	H	F	I	W	P	R	S	T	
G12	10.0	12.8	10.3	11.0±0.2	0 to +0.15	3.2	1.2±0.2	4.6	0.70±0.2	6.9	1.3±0.2	
G16	10.0	16.8	10.3	11.0±0.2	0 to +0.15	3.2	1.2±0.2	4.6	0.70±0.2	6.9	1.3±0.2	

Design and specifications are each subject to change without notice. Ask factory for the current technical specifications before purchase and/or use.  
Should a safety concern arise regarding this product, please be sure to contact us immediately.

## Characteristics list

Endurance : 125 °C 4000 h

Rated voltage (V)	Capacitance (±20 %) (μF)	Case size (mm)			Size code	Specification			Part number		Min. packaging q'ty (pcs)
		øD	L			Ripple current* <sup>1</sup> (mA rms)	ESR* <sup>2</sup> (mΩ)	tan δ* <sup>3</sup>	Standard product	Vibration-proof product	Taping
			Standard	Vibration-proof							
25	680	10.0	12.5	12.8	G12	3500	14	0.14	EEHZS1E681UP	EEHZS1E681UV	400
	1000	10.0	16.5	16.8	G16	4000	11	0.14	EEHZS1E102UP	EEHZS1E102UV	250
35	470	10.0	12.5	12.8	G12	3500	14	0.12	EEHZS1V471UP	EEHZS1V471UV	400
	680	10.0	16.5	16.8	G16	4000	11	0.12	EEHZS1V681UP	EEHZS1V681UV	250
50	180	10.0	12.5	12.8	G12	3200	17	0.10	EEHZS1H181UP	EEHZS1H181UV	400
	270	10.0	16.5	16.8	G16	3700	13	0.10	EEHZS1H271UP	EEHZS1H271UV	250
63	120	10.0	12.5	12.8	G12	3000	19	0.08	EEHZS1J121UP	EEHZS1J121UV	400
	180	10.0	16.5	16.8	G16	3500	15	0.08	EEHZS1J181UP	EEHZS1J181UV	250

\*1: Ripple current (100 kHz / +125 °C)

\*2: ESR (100 kHz / +20 °C)

\*3: tan δ (120 Hz / +20 °C)

◆ Please refer to the page of "Reflow profile" and "The taping dimensions".

## Frequency correction factor for ripple current

Rated capacitance (C)	Frequency (f)	100 Hz ≤ f < 120 Hz	120 Hz ≤ f < 200 Hz	200 Hz ≤ f < 300 Hz	300 Hz ≤ f < 500 Hz
120 μF ≤ C	Correction factor	0.15	0.20	0.25	0.30

Rated capacitance (C)	Frequency (f)	500 Hz ≤ f < 1 kHz	1 kHz ≤ f < 2 kHz	2 kHz ≤ f < 3 kHz	3 kHz ≤ f < 5 kHz
120 μF ≤ C	Correction factor	0.40	0.50	0.60	0.65

Rated capacitance (C)	Frequency (f)	5 kHz ≤ f < 10 kHz	10 kHz ≤ f < 15 kHz	15 kHz ≤ f < 20 kHz	20 kHz ≤ f < 30 kHz
120 μF ≤ C	Correction factor	0.70	0.75	0.80	0.85

Rated capacitance (C)	Frequency (f)	30 kHz ≤ f < 50 kHz	50 kHz ≤ f < 100 kHz	100 kHz ≤ f < 500 kHz	500 kHz ≤ f < 1000 kHz
120 μF ≤ C	Correction factor	0.85	0.90	1.00	1.00



**Conductive Polymer Hybrid Aluminum Electrolytic Capacitors**  
Surface Mount Type

**ZU** series

**High temperature lead-free reflow**

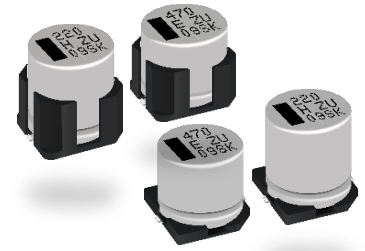

**Features**

- Endurance: 4000 h at 135 °C
- High ripple current compared with ZS series
- Vibration-proof product is available upon request.
- AEC-Q200 compliant
- RoHS compliant

**Specifications**

Size code	G12	G16
Category temp. range	-55 °C to +135 °C	
Rated voltage range	25 V to 63 V	
Nominal cap. range	100 µF to 470 µF	150 µF to 560 µF
Capacitance tolerance	±20 % (120 Hz / +20 °C)	
Leakage current	$I \leq 0.01 CV$ (µA), 2 minutes after reaching rated voltage, 20 °C *CV = (Capacitance in µF) x (Rated voltage in V)	
Dissipation factor (tan δ)	Please see the attached characteristics list	
Surge voltage (V)	Rated voltage × 1.25 (15 °C to 35 °C)	
Endurance 1	+125 °C ± 2 °C, 4000 h, apply the rated ripple current without exceeding the rated voltage	
	Capacitance change	Within ±30% of the initial value
	Dissipation factor (tan δ)	≤ 200 % of the initial limit
	E.S.R.	≤ 200 % of the initial limit
Endurance 2	+135 °C ± 2 °C, 4000 h, apply the rated ripple current without exceeding the rated voltage	
	Capacitance change	Within ±30% of the initial value
	Dissipation factor (tan δ)	≤ 200 % of the initial limit
	E.S.R.	≤ 200 % of the initial limit
Shelf life	After storage for 1000 hours at +135 °C ± 2 °C with no voltage applied and then being stabilized at +20 °C, capacitors shall meet the limits specified in endurance 2. (With voltage treatment)	
	85 °C ± 2 °C, 85 % to 90 %RH, 2000 h, rated voltage applied	
Damp heat (Load)	Capacitance change	
	Within ±30% of the initial value	
	Dissipation factor (tan δ)	
	≤ 200 % of the initial limit	
Resistance to soldering heat	E.S.R.	
	≤ 200 % of the initial limit	
	Leakage current	
	Within the initial limit	

**Marking**

Example : 25 V 470 µF  
Marking color : BLACK

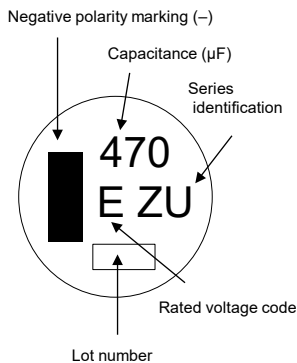

R. voltage code	Unit : V
E	25
V	35
H	50
J	63

**Dimensions (not to scale)**

[Standard]

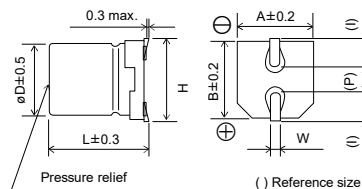

Size code	øD	L	A, B	H	I	W	P
G12	10.0	12.5	10.3	11.0±0.2	3.2	1.2±0.2	4.6
G16	10.0	16.5	10.3	11.0±0.2	3.2	1.2±0.2	4.6

[Vibration-proof product]

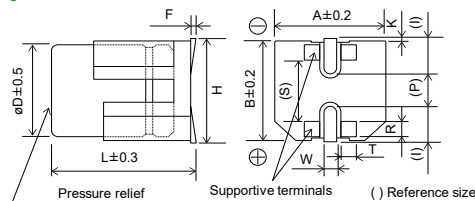

Size code	øD	L	A, B	H	F	I	W	P	R	S	T
G12	10.0	12.8	10.3	11.0±0.2	0 to +0.15	3.2	1.2±0.2	4.6	0.70±0.2	6.9	1.3±0.2
G16	10.0	16.8	10.3	11.0±0.2	0 to +0.15	3.2	1.2±0.2	4.6	0.70±0.2	6.9	1.3±0.2

**Characteristics list**

Endurance 1 : 125 °C 4000 h  
Endurance 2 : 135 °C 4000 h

Rated voltage (V)	Capacitance (±20 %) (µF)	Case size (mm)			Size code	Specification				Part number		Min. packaging q'ty (pcs)
		øD	L			Ripple current *1 (mA rms)	ESR *2 (mΩ)	tan δ *3	Standard product	Vibration-proof product	Taping	
			Standard	Vibration-proof								Endurance 1 (+125°C)
25	470	10.0	12.5	12.8	G12	5000	3500	10	0.14	EEHZU1E471P	EEHZU1E471V	400
	560	10.0	16.5	16.8	G16	5800	4000	8	0.14	EEHZU1E561P	EEHZU1E561V	250
35	330	10.0	12.5	12.8	G12	4800	3300	11	0.12	EEHZU1V331P	EEHZU1V331V	400
	470	10.0	16.5	16.8	G16	5500	3800	9	0.12	EEHZU1V471P	EEHZU1V471V	250
50	150	10.0	12.5	12.8	G12	4600	3200	12	0.10	EEHZU1H151P	EEHZU1H151V	400
	220	10.0	16.5	16.8	G16	5200	3600	10	0.10	EEHZU1H221P	EEHZU1H221V	250
63	100	10.0	12.5	12.8	G12	4600	3200	12	0.08	EEHZU1J101P	EEHZU1J101V	400
	150	10.0	16.5	16.8	G16	5200	3600	10	0.08	EEHZU1J151P	EEHZU1J151V	250

\*1: Ripple current (100 kHz / +125 °C or +135°C)

\*2: ESR (100 kHz / +20 °C)

\*3: tan δ (120 Hz / +20 °C)

◆ Please refer to the page of "Reflow profile" and "The taping dimensions".

**Frequency correction factor for ripple current**

Rated capacitance (C)	Frequency (f)	100 Hz ≤ f < 200 Hz	200 Hz ≤ f < 300 Hz	300 Hz ≤ f < 500 Hz	500 Hz ≤ f < 1 kHz
100 µF ≤ C < 150 µF	Correction factor	0.15	0.20	0.25	0.30
150 µF ≤ C	Correction factor	0.15	0.25	0.25	0.30

Rated capacitance (C)	Frequency (f)	1 kHz ≤ f < 2 kHz	2 kHz ≤ f < 3 kHz	3 kHz ≤ f < 5 kHz	5 kHz ≤ f < 10 kHz
100 µF ≤ C < 150 µF	Correction factor	0.40	0.45	0.55	0.60
150 µF ≤ C	Correction factor	0.45	0.50	0.60	0.65

Rated capacitance (C)	Frequency (f)	10 kHz ≤ f < 15 kHz	15 kHz ≤ f < 20 kHz	20 kHz ≤ f < 30 kHz	30 kHz ≤ f < 40 kHz
100 µF ≤ C < 150 µF	Correction factor	0.70	0.75	0.80	0.80
150 µF ≤ C	Correction factor	0.75	0.80	0.85	0.85

Rated capacitance (C)	Frequency (f)	40 kHz ≤ f < 50 kHz	50 kHz ≤ f < 100 kHz	100 kHz ≤ f < 500 kHz	500 kHz ≤ f
100 µF ≤ C < 150 µF	Correction factor	0.85	0.90	1.00	1.00
150 µF ≤ C	Correction factor	0.85	0.90	1.00	1.00

**After endurance ESR (100 kHz, -40°C)**

Size code	G12	G16
ESR (Ω)	0.3	0.3

**Conductive Polymer Hybrid Aluminum Electrolytic Capacitors**  
Surface Mount Type

**ZUU series High temperature lead-free reflow**



**Features**

- Endurance: 4000 h at 125 °C / 135 °C
- Higher ripple current (max 160 % of ZS series)
- Larger capacitance (max 180 % of ZU series)
- AEC-Q200 compliant
- RoHS compliant

**Specifications**

Size code	G12		G16	
Category temp. range	-55 °C to +135 °C			
Rated voltage range	25 V to 63 V			
Nominal cap.range	120 μF to 680 μF		180 μF to 1000 μF	
Capacitance tolerance	±20 % (120 Hz / +20 °C)			
Leakage current	I ≤ 0.01 CV (μA), 2 minutes after reaching rated voltage, 20 °C *CV = (Capacitance in μF) x (Rated voltage in V)			
Dissipation factor (tan δ)	Please see the attached characteristics list			
Surge voltage (V)	Rated voltage × 1.25 (15 °C to 35 °C)			
Endurance 1	+125 °C ± 2 °C, 4000 h, apply the rated ripple current without exceeding the rated voltage			
	Capacitance change	Within ±30% of the initial value		
	Dissipation factor (tan δ)	≤ 200 % of the initial limit		
	E.S.R.	≤ 200 % of the initial limit		
	Leakage current	Within the initial limit		
Endurance 2	+135 °C ± 2 °C, 4000 h, apply the rated ripple current without exceeding the rated voltage.			
	Capacitance change	Within ±30% of the initial value		
	Dissipation factor (tan δ)	≤ 200 % of the initial limit		
	E.S.R.	≤ 200 % of the initial limit		
	Leakage current	Within the initial limit		
Shelf life	After storage for 1000 hours at +135 °C ± 2 °C with no voltage applied and then being stabilized at +20 °C, capacitors shall meet the limits specified in endurance. (With voltage treatment)			
	85 °C ± 2 °C, 85 % to 90 %RH, 2000 h, rated voltage applied			
	Capacitance change	Within ±30% of the initial value		
Damp heat (Load)	85 °C ± 2 °C, 85 % to 90 %RH, 2000 h, rated voltage applied			
	Capacitance change	Within ±30% of the initial value		
	Dissipation factor (tan δ)	≤ 200 % of the initial limit		
	E.S.R.	≤ 200 % of the initial limit		
Resistance to soldering heat	After reflow soldering and then being stabilized at +20 °C, capacitors shall meet the following limits.			
	Capacitance change	Within ±10% of the initial value		
	Dissipation factor (tan δ)	Within the initial limit		
	Leakage current	Within the initial limit		

**Marking**

Example : 35 V 470 μF  
Marking color : BLACK

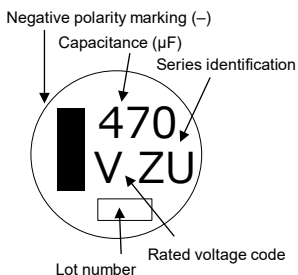

R. voltage code	Unit : V
E	25
V	35
H	50
J	63

**Dimensions (not to scale)**

[Standard]

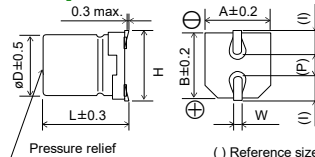

Size code	øD	L	A, B	H	I	W	P
G12	10.0	12.5	10.3	11.0±0.2	3.2	1.2±0.2	4.6
G16	10.0	16.5	10.3	11.0±0.2	3.2	1.2±0.2	4.6

Unit : mm

[Vibration-proof product]

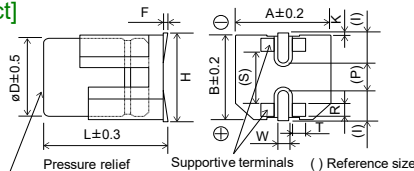

Size code	øD	L	A, B	H	F	I	W	P	R	S	T
G12	10.0	12.8	10.3	11.0±0.2	0 to +0.15	3.2	1.2±0.2	4.6	0.70±0.2	6.9	1.3±0.2
G16	10.0	16.8	10.3	11.0±0.2	0 to +0.15	3.2	1.2±0.2	4.6	0.70±0.2	6.9	1.3±0.2

Unit : mm

## Characteristics list

Endurance 1 : 125 °C 4000 h

Endurance 2 : 135 °C 4000 h

Rated voltage (V)	Capacitance (±20 %) (μF)	Case size (mm)			Size code	Specification				Part number		Min. packaging q'ty (pcs)
		øD	L			Ripple current *1 (mA rms)	ESR *2 (mΩ)	tan δ *3	Standard product	Vibration-proof product	Taping	
			Standard	Vibration-proof								Endurance 1 (+125°C)
25	680	10.0	12.5	12.8	G12	5300	3700	10	0.14	EEHZU1E681UP	EEHZU1E681UV	400
	1000	10.0	16.5	16.8	G16	6100	4300	8	0.14	EEHZU1E102UP	EEHZU1E102UV	250
35	470	10.0	12.5	12.8	G12	5000	3500	11	0.12	EEHZU1V471UP	EEHZU1V471UV	400
	680	10.0	16.5	16.8	G16	5800	4100	9	0.12	EEHZU1V681UP	EEHZU1V681UV	250
50	180	10.0	12.5	12.8	G12	4800	3400	12	0.10	EEHZU1H181UP	EEHZU1H181UV	400
	270	10.0	16.5	16.8	G16	5500	3800	10	0.10	EEHZU1H271UP	EEHZU1H271UV	250
63	120	10.0	12.5	12.8	G12	4800	3400	12	0.08	EEHZU1J121UP	EEHZU1J121UV	400
	180	10.0	16.5	16.8	G16	5500	3800	10	0.08	EEHZU1J181UP	EEHZU1J181UV	250

\*1: Ripple current (100 kHz / +125 °C or +135 °C)

\*2: ESR (100 kHz / +20 °C)

\*3: tan δ (120 Hz / +20 °C)

◆ Please refer to the page of "Reflow profile" and "The taping dimensions".

## Frequency correction factor for ripple current

Rated capacitance (C)	Frequency (f)	100 Hz ≤ f < 200 Hz	200 Hz ≤ f < 300 Hz	300 Hz ≤ f < 500 Hz	500 Hz ≤ f < 1 kHz
120 μF ≤ C < 150 μF	Correction factor	0.15	0.20	0.25	0.30
150 μF ≤ C		0.15	0.25	0.25	0.30

Rated capacitance (C)	Frequency (f)	1 kHz ≤ f < 2 kHz	2 kHz ≤ f < 3 kHz	3 kHz ≤ f < 5 kHz	5 kHz ≤ f < 10 kHz
120 μF ≤ C < 150 μF	Correction factor	0.40	0.45	0.55	0.60
150 μF ≤ C		0.45	0.50	0.60	0.65

Rated capacitance (C)	Frequency (f)	10 kHz ≤ f < 15 kHz	15 kHz ≤ f < 20 kHz	20 kHz ≤ f < 30 kHz	30 kHz ≤ f < 40 kHz
120 μF ≤ C < 150 μF	Correction factor	0.70	0.75	0.80	0.80
150 μF ≤ C		0.75	0.80	0.85	0.85

Rated capacitance (C)	Frequency (f)	40 kHz ≤ f < 50 kHz	50 kHz ≤ f < 100 kHz	100 kHz ≤ f < 500 kHz	500 kHz ≤ f < 1000 kHz
120 μF ≤ C < 150 μF	Correction factor	0.85	0.90	1.00	1.00
150 μF ≤ C		0.85	0.90	1.00	1.00

**Conductive Polymer Hybrid Aluminum Electrolytic Capacitors**  
Surface Mount Type

**ZE** series

**High temperature lead-free reflow**

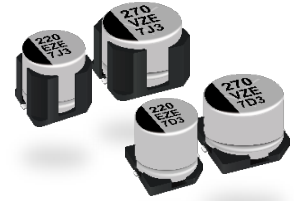

**Features**

- Endurance: 2000 h at 145 °C (High temperature / Long life)
- Low ESR and high ripple current
- High-withstand voltage (to 63 V)
- Characteristics dependencies in frequency and low temperature are as small as polymer type
- Vibration-proof product is available upon request
- AEC-Q200 compliant
- RoHS compliant

**Specifications**

Size code	F	G
Category temp. range	-55 °C to +145 °C	
Rated voltage range	25 V to 63 V	
Nominal cap.range	33 µF to 220 µF	56 µF to 330 µF
Capacitance tolerance	±20 % (120 Hz / +20 °C)	
Leakage current	$I \leq 0.01 CV$ (µA), 2 minutes after reaching rated voltage, 20 °C *CV = (Capacitance in µF) x (Rated voltage in V)	
Dissipation factor (tan δ)	Please see the attached characteristics list	
Surge voltage (V)	Rated voltage × 1.25 (15 °C to 35 °C)	
Endurance 1	+145 °C ± 2 °C, 2000 h, apply the rated ripple current without exceeding the rated voltage	
	Capacitance change	Within ±30% of the initial value
	Dissipation factor (tan δ)	≤ 200 % of the initial limit
	E.S.R.	≤ 200 % of the initial limit
Endurance 2	+135 °C ± 2 °C, 4000 h, apply the rated ripple current without exceeding the rated voltage	
	Capacitance change	Within ±30% of the initial value
	Dissipation factor (tan δ)	≤ 200 % of the initial limit
	E.S.R.	≤ 200 % of the initial limit
Shelf life	After storage for 1000 hours at +145 °C ± 2 °C with no voltage applied and then being stabilized at +20 °C, capacitors shall meet the limits specified in endurance 1. (With voltage treatment)	
	85 °C ± 2 °C, 85 % to 90 %RH, 2000 h, rated voltage applied	
Damp heat (Load)	Capacitance change	
	Dissipation factor (tan δ)	
	E.S.R.	
	Leakage current	
Resistance to soldering heat	After reflow soldering and then being stabilized at +20 °C, capacitors shall meet the following limits.	
	Capacitance change	
	Dissipation factor (tan δ)	
	Leakage current	

**Marking**

Example : 25 V 220 µF  
Marking color : BLACK  
Negative polarity marking (-)

Capacitance (µF)  
Series identification  
Rated voltage code  
Lot number

R. voltage code	Unit : V
E	25
V	35
H	50
J	63

**Dimensions (not to scale)**

[Standard]

Size code	øD	L	A, B	H max.	I	W	P	K
F	8.0	10.2±0.3	8.3	10	3.4	0.90±0.2	3.1	0.70±0.2
G	10.0	10.2±0.3	10.3	12.0	3.5	0.90±0.2	4.6	0.70±0.2

[Vibration-proof product]

Size code	øD	L	A, B	H max.	F	I	W	P	K	R	S	T
F	8.0	10.5±0.3	8.3	10.0	0 to +0.15	3.4	1.2±0.2	3.1	0.70±0.2	0.70±0.2	5.3	1.3±0.2
G	10.0	10.5±0.3	10.3	12.0	0 to +0.15	3.5	1.2±0.2	4.6	0.70±0.2	0.70±0.2	6.9	1.3±0.2

## Characteristics list

Endurance 1 : 145 °C 2000 h

Endurance 2 : 135 °C 4000 h

Rated voltage (V)	Capacitance (±20 %) (μF)	Case size (mm)			Size code	Specification				Part number		Min. packaging q'ty (pcs)
		øD	L			Ripple current *1 (mA rms)	ESR*2 (mΩ)	tan δ*3	Standard product	Vibration-proof product	Taping	
			Standard	Vibration-proof								Endurance 1 (+145°C)
25	220	8.0	10.2	10.5	F	700	1600	27	0.14	EEHZE1E221P	EEHZE1E221V	500
	330	10.0	10.2	10.5	G	900	2000	20	0.14	EEHZE1E331P	EEHZE1E331V	500
35	150	8.0	10.2	10.5	F	700	1600	27	0.12	EEHZE1V151P	EEHZE1V151V	500
	270	10.0	10.2	10.5	G	900	2000	20	0.12	EEHZE1V271P	EEHZE1V271V	500
50	68	8.0	10.2	10.5	F	600	1250	30	0.10	EEHZE1H680P	EEHZE1H680V	500
	100	10.0	10.2	10.5	G	800	1600	28	0.10	EEHZE1H101P	EEHZE1H101V	500
63	33	8.0	10.2	10.5	F	600	1100	40	0.08	EEHZE1J330P	EEHZE1J330V	500
	56	10.0	10.2	10.5	G	800	1400	30	0.08	EEHZE1J560P	EEHZE1J560V	500
	82	10.0	10.2	10.5	G	800	1400	30	0.08	EEHZE1J820P	EEHZE1J820V	500

\*1: Ripple current (100 kHz / +145 °C or +135°C)

\*2: ESR (100 kHz / +20 °C)

\*3: tan δ (120 Hz / +20 °C)

◆ Please refer to the page of "Reflow profile" and "The taping dimensions".

◆ The dimensions of the vibration-proof products, please refer to the page of the mounting specification.

## Frequency correction factor for ripple current

Rated capacitance (C)	Frequency (f)	100 Hz ≤ f < 200 Hz	200 Hz ≤ f < 300 Hz	300 Hz ≤ f < 500 Hz	500 Hz ≤ f < 1 kHz
C < 47 μF	Correction factor	0.10	0.10	0.15	0.20
47 μF ≤ C < 150 μF		0.15	0.20	0.25	0.30
150 μF ≤ C		0.15	0.25	0.25	0.30

Rated capacitance (C)	Frequency (f)	1 kHz ≤ f < 2 kHz	2 kHz ≤ f < 3 kHz	3 kHz ≤ f < 5 kHz	5 kHz ≤ f < 10 kHz
C < 47 μF	Correction factor	0.30	0.40	0.45	0.50
47 μF ≤ C < 150 μF		0.40	0.45	0.55	0.60
150 μF ≤ C		0.45	0.50	0.60	0.65

Rated capacitance (C)	Frequency (f)	10 kHz ≤ f < 15 kHz	15 kHz ≤ f < 20 kHz	20 kHz ≤ f < 30 kHz	30 kHz ≤ f < 40 kHz
C < 47 μF	Correction factor	0.60	0.65	0.70	0.75
47 μF ≤ C < 150 μF		0.70	0.75	0.80	0.80
150 μF ≤ C		0.75	0.80	0.85	0.85

Rated capacitance (C)	Frequency (f)	40 kHz ≤ f < 50 kHz	50 kHz ≤ f < 100 kHz	100 kHz ≤ f < 500 kHz	500 kHz ≤ f
C < 47 μF	Correction factor	0.80	0.85	1.00	1.05
47 μF ≤ C < 150 μF		0.85	0.90	1.00	1.00
150 μF ≤ C		0.85	0.90	1.00	1.00

## After endurance ESR (100 kHz, -40°C)

Size code	F	G
ESR (Ω)	0.4	0.3

# Conductive Polymer Hybrid Aluminum Electrolytic Capacitors

## Surface Mount Type

ZF series

High temperature lead-free reflow

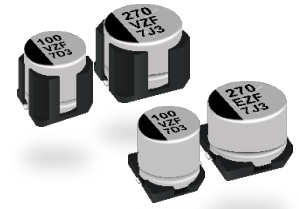

### Features

- Endurance : 1000 h at 150 °C (High temperature)
- Low ESR and high ripple current
- High-withstand voltage (to 63 V)
- Vibration-proof product is available upon request
- AEC-Q200 compliant
- RoHS compliant

### Specifications

Size code	F	G
Category temp. range	-55 °C to +150 °C	
Rated voltage range	25 V to 63 V	
Nominal cap.range	33 µF to 150 µF	56 µF to 270 µF
Capacitance tolerance	±20 % (120 Hz / +20°C)	
Leakage current	$I \leq 0.01 CV (\mu A)$ , 2 minutes after reaching rated voltage, 20 °C *CV = (Capacitance in µF) x (Rated voltage in V)	
Dissipation factor (tan δ)	Please see the attached characteristics list	
Surge voltage (V)	Rated voltage × 1.25 (15 °C to 35 °C)	
Endurance	+150 °C ± 2 °C, 1000 h, apply the rated ripple current without exceeding the rated voltage.	
	Capacitance change	Within ±30% of the initial value
	Dissipation factor (tan δ)	≤ 200 % of the initial limit
	ESR	≤ 200 % of the initial limit
	Leakage current	Within the initial limit
ESR after endurance (Ω / 100 kHz)(-40 °C)	Size code	
	F	G
	0.4	0.3
Shelf life	After storage for 1000 hours at +150 °C ± 2 °C with no voltage applied and then being stabilized at +20 °C, capacitors shall meet the limits specified in endurance. (With voltage treatment)	
Damp heat (Load)	+85 °C ± 2 °C, 85 % to 90 %RH, 2000 h, rated voltage applied	
	Capacitance change	Within ±30% of the initial value
	Dissipation factor (tan δ)	≤ 200 % of the initial limit
	ESR	≤ 200 % of the initial limit
Resistance to soldering heat	After reflow soldering and then being stabilized at +20 °C, capacitors shall meet the following limits.	
	Capacitance change	Within ±10% of the initial value
	Dissipation factor (tan δ)	Within the initial limit
	Leakage current	Within the initial limit

### Marking

Example : 25 V 150 µF  
Marking color : BLACK

Negative polarity marking (-)

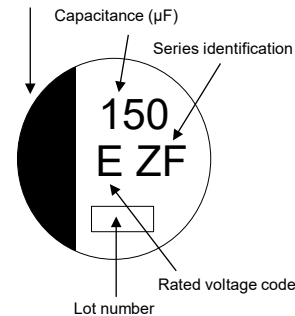

R. voltage code	Unit : V
E	25
V	35
H	50
J	63

### Dimensions (not to scale)

[Standard]

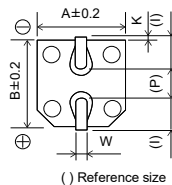
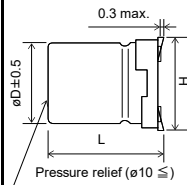

Size code	øD	L	A, B	H <sub>max.</sub>	I	W	P	K
F	8.0	10.2±0.3	8.3	10	3.4	0.90±0.2	3.1	0.70±0.2
G	10.0	10.2±0.3	10.3	12.0	3.5	0.90±0.2	4.6	0.70±0.2

Unit : mm

[Vibration-proof product]

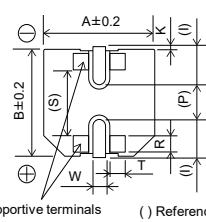
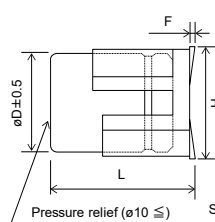

Size code	øD	L	A, B	H <sub>max.</sub>	F	I	W	P	K	R	S	T
F	8.0	10.5±0.3	8.3	10.0	0 to +0.15	3.4	1.2±0.2	3.1	0.70±0.2	0.70±0.2	5.3	1.3±0.2
G	10.0	10.5±0.3	10.3	12.0	0 to +0.15	3.5	1.2±0.2	4.6	0.70±0.2	0.70±0.2	6.9	1.3±0.2

Unit : mm

## Characteristics list

Endurance : 150 °C 1000 h

Rated voltage (V)	Capacitance (±20 %) (μF)	Case size (mm)			Size code	Specification			Part number		Min. packaging q'ty (pcs)
		øD	L			Ripple current* <sup>1</sup> (mA rms)	ESR* <sup>2</sup> (mΩ)	tan δ* <sup>3</sup>	Standard product	Vibration-proof product	Taping
			Standard	Vibration-proof							
25	150	8.0	10.2	10.5	F	800	27	0.14	EEHZF1E151P	EEHZF1E151V	500
	270	10.0	10.2	10.5	G	1000	20	0.14	EEHZF1E271P	EEHZF1E271V	500
35	100	8.0	10.2	10.5	F	770	30	0.12	EEHZF1V101P	EEHZF1V101V	500
	150	10.0	10.2	10.5	G	950	23	0.12	EEHZF1V151P	EEHZF1V151V	500
50	56	8.0	10.2	10.5	F	700	35	0.10	EEHZF1H560P	EEHZF1H560V	500
	100	10.0	10.2	10.5	G	900	28	0.10	EEHZF1H101P	EEHZF1H101V	500
63	33	8.0	10.2	10.5	F	650	40	0.08	EEHZF1J330P	EEHZF1J330V	500
	56	10.0	10.2	10.5	G	840	30	0.08	EEHZF1J560P	EEHZF1J560V	500

\*1: Ripple current (100 kHz / +150 °C)

\*2: ESR (100 kHz / +20 °C)

\*3: tan δ (120 Hz / +20 °C)

◆ Please refer to the page of "Reflow profile" and "The taping dimensions".

## Frequency correction factor for ripple current

Rated capacitance (C)	Frequency (f)	100 Hz ≤ f < 200 Hz	200 Hz ≤ f < 300 Hz	300 Hz ≤ f < 500 Hz	500 Hz ≤ f < 1 kHz
C < 47 μF	Correction factor	0.10	0.10	0.15	0.20
47 μF ≤ C < 150 μF		0.15	0.20	0.25	0.30
150 μF ≤ C		0.15	0.25	0.25	0.30
Rated capacitance (C)	Frequency (f)	1 kHz ≤ f < 2 kHz	2 kHz ≤ f < 3 kHz	3 kHz ≤ f < 5 kHz	5 kHz ≤ f < 10 kHz
C < 47 μF	Correction factor	0.30	0.40	0.45	0.50
47 μF ≤ C < 150 μF		0.40	0.45	0.55	0.60
150 μF ≤ C		0.45	0.50	0.60	0.65
Rated capacitance (C)	Frequency (f)	10 kHz ≤ f < 15 kHz	15 kHz ≤ f < 20 kHz	20 kHz ≤ f < 30 kHz	30 kHz ≤ f < 40 kHz
C < 47 μF	Correction factor	0.60	0.65	0.70	0.75
47 μF ≤ C < 150 μF		0.70	0.75	0.80	0.80
150 μF ≤ C		0.75	0.80	0.85	0.85
Rated capacitance (C)	Frequency (f)	40 kHz ≤ f < 50 kHz	50 kHz ≤ f < 100 kHz	100 kHz ≤ f < 500 kHz	500 kHz ≤ f
C < 47 μF	Correction factor	0.80	0.85	1.00	1.05
47 μF ≤ C < 150 μF		0.85	0.90	1.00	1.00
150 μF ≤ C		0.85	0.90	1.00	1.00



**Conductive Polymer Hybrid Aluminum  
Electrolytic Capacitors**  
Radial Lead Type  
**ZA-A series**

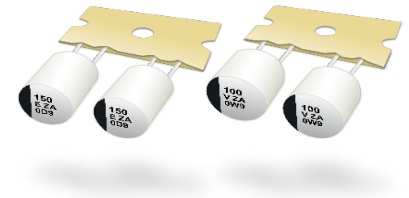

**Features**

- Endurance : 10000 h at 105 °C (105 °C standard product)
- Taping products for automatic insertion
- AEC-Q200 compliant
- RoHS compliant

**Specifications**

Size code	F		G	
Category temp. range	-55 °C to +105 °C			
Rated voltage range	25 V to 80 V			
Nominal cap. range	22 µF to 220 µF		33 µF to 330 µF	
Capacitance tolerance	±20 % (120 Hz / +20°C)			
Leakage current	I ≤ 0.01 CV (µA), 2 minutes after reaching rated voltage, 20 °C *CV = (Capacitance in µF) x (Rated voltage in V)			
Dissipation factor (tan δ)	Please see the attached characteristics list			
Surge voltage (V)	Rated voltage × 1.25 (15 °C to 35 °C)			
Endurance	+105 °C ± 2 °C, 10000 h, apply the rated ripple current without exceeding the rated voltage.			
	Capacitance change	Within ±30% of the initial value		
	Dissipation factor (tan δ)	≤ 200 % of the initial limit		
	ESR	≤ 200 % of the initial limit		
	Leakage current	Within the initial limit		
ESR after endurance (Ω / 100 kHz)(-40 °C)	Size code			
	F	G		
	0.4	0.3		
Shelf life	After storage for 1000 hours at +105 °C ± 2 °C with no voltage applied and then being stabilized at +20 °C, capacitors shall meet the limits specified in endurance. (With voltage treatment)			
Damp heat (Load)	+85 °C ± 2 °C, 85 % to 90 %RH, 2000 h, rated voltage applied			
	Capacitance change	Within ±30% of the initial value		
	Dissipation factor (tan δ)	≤ 200 % of the initial limit		
	ESR	≤ 200 % of the initial limit		
Leakage current	Within the initial limit			
Resistance to soldering heat	After flow soldering and then being stabilized at +20 °C, capacitors shall meet the following limits.			
	Capacitance change	Within ±10% of the initial value		
	Dissipation factor (tan δ)	Within the initial limit		
	Leakage current	Within the initial limit		

**Marking**

Example : 25 V 150 µF  
Marking color : BLACK

Negative polarity marking (-)

Capacitance (µF)

Series identification

Rated voltage code

Lot number

R.voltage code	Unit : V
E	25
V	35
H	50
J	63
K	80

**Dimensions (not to scale)**

Size code	øD	L	ød	F	P1
F	8.0	9.5	0.6	3.5±0.5	4.60±0.50
G	10.0	9.5	0.6	5.0 <sup>+0.8</sup> <sub>-0.2</sub>	3.85±0.50

Unit : mm

## Characteristics list

Endurance : 105 °C 10000 h

Rated voltage (V)	Capacitance (±20 %) (μF)	Case size (mm)			Size code	Specification			Part number	Min. packaging q'ty (pcs)
		øD	L	ød		Ripple current *1 (mA rms)	ESR *2 (mΩ)	tan δ *3		Taping
25	150	8.0	9.5	0.6	F	2300	27	0.14	EEHAZA1E151B	1000
	220	8.0	9.5	0.6	F	2300	27	0.14	EEHAZA1E221B	1000
	330	10.0	9.5	0.6	G	2500	20	0.14	EEHAZA1E331B	500
35	100	8.0	9.5	0.6	F	2300	27	0.12	EEHAZA1V101B	1000
	150	8.0	9.5	0.6	F	2300	27	0.12	EEHAZA1V151B	1000
	220	10.0	9.5	0.6	G	2500	20	0.12	EEHAZA1V221B	500
	270	10.0	9.5	0.6	G	2500	20	0.12	EEHAZA1V271B	500
50	47	8.0	9.5	0.6	F	1800	30	0.10	EEHAZA1H470B	1000
	68	8.0	9.5	0.6	F	1800	30	0.10	EEHAZA1H680B	1000
	100	10.0	9.5	0.6	G	2000	28	0.10	EEHAZA1H101B	500
63	33	8.0	9.5	0.6	F	1700	40	0.08	EEHAZA1J330B	1000
	47	8.0	9.5	0.6	F	1700	40	0.08	EEHAZA1J470B	1000
	56	10.0	9.5	0.6	G	1800	30	0.08	EEHAZA1J560B	500
	68	10.0	9.5	0.6	G	1800	30	0.08	EEHAZA1J680B	500
	82	10.0	9.5	0.6	G	1800	30	0.08	EEHAZA1J820B	500
80	22	8.0	9.5	0.6	F	1550	45	0.08	EEHAZA1K220B	1000
	33	10.0	9.5	0.6	G	1700	36	0.08	EEHAZA1K330B	500
	47	10.0	9.5	0.6	G	1700	36	0.08	EEHAZA1K470B	500

\*1: Ripple current (100 kHz / +105 °C)

\*2: ESR (100 kHz / +20 °C)

\*3: tan δ (120 Hz / +20 °C)

◆ Please refer to the page of "Flow soldering profile" and "The taping dimensions".

## Frequency correction factor for ripple current

Rated capacitance (C)	Frequency (f)	100 Hz ≤ f < 200 Hz	200 Hz ≤ f < 300 Hz	300 Hz ≤ f < 500 Hz	500 Hz ≤ f < 1 kHz
C < 47 μF	Correction factor	0.10	0.10	0.15	0.20
47 μF ≤ C < 150 μF		0.15	0.20	0.25	0.30
150 μF ≤ C		0.15	0.25	0.25	0.30
Rated capacitance (C)	Frequency (f)	1 kHz ≤ f < 2 kHz	2 kHz ≤ f < 3 kHz	3 kHz ≤ f < 5 kHz	5 kHz ≤ f < 10 kHz
C < 47 μF	Correction factor	0.30	0.40	0.45	0.50
47 μF ≤ C < 150 μF		0.40	0.45	0.55	0.60
150 μF ≤ C		0.45	0.50	0.60	0.65
Rated capacitance (C)	Frequency (f)	10 kHz ≤ f < 15 kHz	15 kHz ≤ f < 20 kHz	20 kHz ≤ f < 30 kHz	30 kHz ≤ f < 40 kHz
C < 47 μF	Correction factor	0.60	0.65	0.70	0.75
47 μF ≤ C < 150 μF		0.70	0.75	0.80	0.80
150 μF ≤ C		0.75	0.80	0.85	0.85
Rated capacitance (C)	Frequency (f)	40 kHz ≤ f < 50 kHz	50 kHz ≤ f < 100 kHz	100 kHz ≤ f < 500 kHz	500 kHz ≤ f < 1000 kHz
C < 47 μF	Correction factor	0.80	0.85	1.00	1.05
47 μF ≤ C < 150 μF		0.85	0.90	1.00	1.00
150 μF ≤ C		0.85	0.90	1.00	1.00

**Conductive Polymer Hybrid Aluminum Electrolytic Capacitors**  
Radial Lead Type  
**ZC-A series**

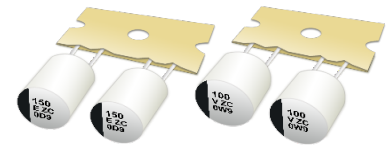

**Features**

- Endurance : 4000 h at 125 °C (125 °C standard product)
- Taping products for automatic insertion
- AEC-Q200 compliant
- RoHS compliant

**Specifications**

Size code	F	G
Category temp. range	-55 °C to +125 °C	
Rated voltage range	25 V to 80 V	
Nominal cap.range	22 μF to 220 μF	33 μF to 330 μF
Capacitance tolerance	±20 % (120 Hz / +20°C)	
Leakage current	I ≤ 0.01 CV (μA), 2 minutes after reaching rated voltage, 20 °C *CV = (Capacitance in μF) x (Rated voltage in V)	
Dissipation factor (tan δ)	Please see the attached characteristics list	
Surge voltage (V)	Rated voltage × 1.25 (15 °C to 35 °C)	
Endurance 1	+125 °C ± 2 °C, 4000 h, apply the rated ripple current without exceeding the rated voltage.	
	Capacitance change	Within ±30% of the initial value
	Dissipation factor (tan δ)	≤ 200 % of the initial limit
	ESR	≤ 200 % of the initial limit
Endurance 2	+125 °C ± 2 °C, 3000 h, apply the rated ripple current without exceeding the rated voltage.	
	Capacitance change	Within ±30% of the initial value
	Dissipation factor (tan δ)	≤ 200 % of the initial limit
	ESR	≤ 300 % of the initial limit
Shelf life	After storage for 1000 hours at +125 °C ± 2 °C with no voltage applied and then being stabilized at +20 °C, capacitors shall meet the limits specified in endurance 1. (With voltage treatment)	
Damp heat (Load)	+85 °C ± 2 °C, 85 % to 90 %RH, 2000 h, rated voltage applied	
	Capacitance change	Within ±30% of the initial value
	Dissipation factor (tan δ)	≤ 200 % of the initial limit
	ESR	≤ 200 % of the initial limit
Resistance to soldering heat	After flow soldering and then being stabilized at +20 °C, capacitors shall meet the following limits.	
	Capacitance change	Within ±10% of the initial value
	Dissipation factor (tan δ)	Within the initial limit
	Leakage current	Within the initial limit

**Marking**

Example : 25 V 150 μF  
Marking color : BLACK

Negative polarity marking (-)

Capacitance (μF)

Series identification

Rated voltage code

Lot number

R.voltage code	Unit : V
E	25
V	35
H	50
J	63
K	80

**Dimensions (not to scale)**

Size code	øD	L	ød	F	P1
F	8.0	9.5	0.6	3.5±0.5	4.60±0.50
G	10.0	9.5	0.6	5.0 <sup>+0.8</sup> <sub>-0.2</sub>	3.85±0.50

Unit : mm

**Characteristics list**

Endurance 1 : 125 °C 4000 h

Endurance 2 : 125 °C 3000 h

Rated voltage (V)	Capacitance (±20 %) (µF)	Case size (mm)			Size code	Specification				Part number	Min. packaging q'ty (pcs)
		øD	L	ød		Ripple current *1 (mA rms)		ESR *2 (mΩ)	tan δ *3		Taping
						Endurance 1	Endurance 2				
25	150	8.0	9.5	0.6	F	1600	1900	27	0.14	EEHAZC1E151B	1000
	220	8.0	9.5	0.6	F	1600	1900	27	0.14	EEHAZC1E221B	1000
	330	10.0	9.5	0.6	G	2000	2900	20	0.14	EEHAZC1E331B	500
35	100	8.0	9.5	0.6	F	1600	1900	27	0.12	EEHAZC1V101B	1000
	150	8.0	9.5	0.6	F	1600	1900	27	0.12	EEHAZC1V151B	1000
	220	10.0	9.5	0.6	G	2000	2800	20	0.12	EEHAZC1V221B	500
50	270	10.0	9.5	0.6	G	2000	2800	20	0.12	EEHAZC1V271B	500
	47	8.0	9.5	0.6	F	1250	-	30	0.10	EEHAZC1H470B	1000
	68	8.0	9.5	0.6	F	1250	-	30	0.10	EEHAZC1H680B	1000
63	100	10.0	9.5	0.6	G	1600	-	28	0.10	EEHAZC1H101B	500
	120	10.0	9.5	0.6	G	1600	-	28	0.10	EEHAZC1H121B	500
	33	8.0	9.5	0.6	F	1100	-	40	0.08	EEHAZC1J330B	1000
	47	8.0	9.5	0.6	F	1100	-	40	0.08	EEHAZC1J470B	1000
80	56	10.0	9.5	0.6	G	1400	-	30	0.08	EEHAZC1J560B	500
	68	10.0	9.5	0.6	G	1400	-	30	0.08	EEHAZC1J680B	500
	82	10.0	9.5	0.6	G	1400	-	30	0.08	EEHAZC1J820B	500
	22	8.0	9.5	0.6	F	1050	-	45	0.08	EEHAZC1K220B	1000
80	33	10.0	9.5	0.6	G	1360	-	36	0.08	EEHAZC1K330B	500
	47	10.0	9.5	0.6	G	1360	-	36	0.08	EEHAZC1K470B	500

\*1: Ripple current (100 kHz / +125 °C)

\*2: ESR (100 kHz / +20 °C)

\*3: tan δ (120 Hz / +20 °C)

◆ Please refer to the page of "Flow soldering profile" and "The taping dimensions".

**Frequency correction factor for ripple current**

Rated capacitance (C)	Frequency (f)	100 Hz ≤ f < 200 Hz	200 Hz ≤ f < 300 Hz	300 Hz ≤ f < 500 Hz	500 Hz ≤ f < 1 kHz
C < 47 µF	Correction factor	0.10	0.10	0.15	0.20
47 µF ≤ C < 150 µF		0.15	0.20	0.25	0.30
150 µF ≤ C		0.15	0.25	0.25	0.30

Rated capacitance (C)	Frequency (f)	1 kHz ≤ f < 2 kHz	2 kHz ≤ f < 3 kHz	3 kHz ≤ f < 5 kHz	5 kHz ≤ f < 10 kHz
C < 47 µF	Correction factor	0.30	0.40	0.45	0.50
47 µF ≤ C < 150 µF		0.40	0.45	0.55	0.60
150 µF ≤ C		0.45	0.50	0.60	0.65

Rated capacitance (C)	Frequency (f)	10 kHz ≤ f < 15 kHz	15 kHz ≤ f < 20 kHz	20 kHz ≤ f < 30 kHz	30 kHz ≤ f < 40 kHz
C < 47 µF	Correction factor	0.60	0.65	0.70	0.75
47 µF ≤ C < 150 µF		0.70	0.75	0.80	0.80
150 µF ≤ C		0.75	0.80	0.85	0.85

Rated capacitance (C)	Frequency (f)	40 kHz ≤ f < 50 kHz	50 kHz ≤ f < 100 kHz	100 kHz ≤ f < 500 kHz	500 kHz ≤ f < 1000 kHz
C < 47 µF	Correction factor	0.80	0.85	1.00	1.05
47 µF ≤ C < 150 µF		0.85	0.90	1.00	1.00
150 µF ≤ C		0.85	0.90	1.00	1.00

**After endurance ESR (100 kHz, -40 °C)**

Size code	F (ø8 x L9.5)	G (ø10 x L9.5)
ESR (Ω)	0.4	0.3

**Conductive Polymer Hybrid Aluminum  
Electrolytic Capacitors**  
Radial Lead Type  
**ZK-A series**

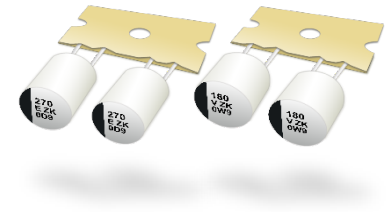

**Features**

- Endurance : 4000 h at 125 °C (Large capacitance / High ripple current)
- Taping products for automatic insertion
- AEC-Q200 compliant
- RoHS compliant

**Specifications**

Size code	F	G
Category temp. range	-55 °C to +125 °C	
Rated voltage range	25 V to 35 V	
Nominal cap.range	180 µF to 270 µF	330 µF to 470 µF
Capacitance tolerance	±20 % (120 Hz / +20°C)	
Leakage current	$I \leq 0.01 CV$ (µA), 2 minutes after reaching rated voltage, 20 °C *CV = (Capacitance in µF) x (Rated voltage in V)	
Dissipation factor (tan δ)	Please see the attached characteristics list	
Surge voltage (V)	Rated voltage × 1.25 (15 °C to 35 °C)	
Endurance	+125 °C ± 2 °C, 4000 h, apply the rated ripple current without exceeding the rated voltage.	
	Capacitance change	Within ±30% of the initial value
	Dissipation factor (tan δ)	≤ 200 % of the initial limit
	ESR	≤ 200 % of the initial limit
	Leakage current	Within the initial limit
ESR after endurance (Ω / 100 kHz)(-40 °C)	Size code	
	F	G
	0.4	0.3
Shelf life	After storage for 1000 hours at +125 °C ± 2 °C with no voltage applied and then being stabilized at +20 °C, capacitors shall meet the limits specified in endurance. (With voltage treatment)	
Damp heat (Load)	+85 °C ± 2 °C, 85 % to 90 %RH, 2000 h, rated voltage applied	
	Capacitance change	Within ±30% of the initial value
	Dissipation factor (tan δ)	≤ 200 % of the initial limit
	ESR	≤ 200 % of the initial limit
Leakage current	Within the initial limit	
Resistance to soldering heat	After flow soldering and then being stabilized at +20 °C, capacitors shall meet the following limits.	
	Capacitance change	Within ±10% of the initial value
	Dissipation factor (tan δ)	Within the initial limit
	Leakage current	Within the initial limit

**Marking**

Example : 25 V 270 µF  
Marking color : BLACK

Negative polarity marking (-)  
Capacitance (µF)  
Series identification  
Rated voltage code  
Lot number

R.voltage code	Unit : V
E	25
V	35

**Dimensions (not to scale)**

6.35±1.0    12.7±1.0    øD±0.5    Pressure relief (ø 10 and larger)    1.0≥    1.0≥

0 to 1.5    L±1.0    ød±0.05    +0.75 -0.50    18.50

18.0±0.5    6.0≥    P1    F    0.6±0.3

ø4.0±0.2    12.7±0.2

Unit : mm

Size code	øD	L	ød	F	P1
F	8.0	9.5	0.6	3.5±0.5	4.60±0.50
G	10.0	9.5	0.6	5.0 <sup>+0.8</sup> <sub>-0.2</sub>	3.85±0.50

## Characteristics list

Endurance : 125 °C 4000 h

Rated voltage (V)	Capacitance (±20 %) (μF)	Case size (mm)			Size code	Specification			Part number	Min. packaging q'ty (pcs)
		øD	L	ød		Ripple current <sup>*1</sup> (mA rms)	ESR <sup>*2</sup> (mΩ)	tan δ <sup>*3</sup>		Taping
25	270	8.0	9.5	0.6	F	2000	27	0.14	EEHAZK1E271B	1000
	470	10.0	9.5	0.6	G	2800	20	0.14	EEHAZK1E471B	500
35	180	8.0	9.5	0.6	F	2000	27	0.12	EEHAZK1V181B	1000
	330	10.0	9.5	0.6	G	2800	20	0.12	EEHAZK1V331B	500

\*1: Ripple current (100 kHz / +125 °C)

\*2: ESR (100 kHz / +20 °C)

\*3: tan δ (120 Hz / +20 °C)

◆ Please refer to the page of "Flow soldering profile" and "The taping dimensions".

## Frequency correction factor for ripple current

Frequency (f)	100 Hz ≤ f < 120 Hz	120 Hz ≤ f < 200 Hz	200 Hz ≤ f < 300 Hz	300 Hz ≤ f < 500 Hz
Correction factor	0.15	0.20	0.25	0.30
Frequency (f)	500 Hz ≤ f < 1 kHz	1 kHz ≤ f < 2 kHz	2 kHz ≤ f < 3 kHz	3 kHz ≤ f < 5 kHz
Correction factor	0.40	0.50	0.60	0.65
Frequency (f)	5 kHz ≤ f < 10 kHz	10 kHz ≤ f < 15 kHz	15 kHz ≤ f < 20 kHz	20 kHz ≤ f < 30 kHz
Correction factor	0.70	0.75	0.80	0.85
Frequency (f)	30 kHz ≤ f < 40 kHz	40 kHz ≤ f < 50 kHz	50 kHz ≤ f < 100 kHz	100 kHz ≤ f < 1000 kHz
Correction factor	0.85	0.85	0.90	1.00

**Conductive Polymer Hybrid Aluminum  
Electrolytic Capacitors**  
Radial Lead Type  
**ZKU-A series**



**Features**

- Endurance : 4000 h at 125 °C (Large capacitance / High ripple current)
- Taping products for automatic insertion
- AEC-Q200 compliant
- RoHS compliant

**Specifications**

Size code	F		G	
Category temp. range	-55 °C to +125 °C			
Rated voltage range	25 V to 35 V			
Nominal cap.range	220 µF to 330 µF		390 µF to 560 µF	
Capacitance tolerance	±20 % (120 Hz / +20°C)			
Leakage current	I ≤ 0.01 CV (µA), 2 minutes after reaching rated voltage, 20 °C *CV = (Capacitance in µF) x (Rated voltage in V)			
Dissipation factor (tan δ)	Please see the attached characteristics list			
Surge voltage (V)	Rated voltage × 1.25 (15 °C to 35 °C)			
Endurance	+125 °C ± 2 °C, 4000 h, apply the rated ripple current without exceeding the rated voltage.			
	Capacitance change	Within ±30% of the initial value		
	Dissipation factor (tan δ)	≤ 200 % of the initial limit		
	ESR	≤ 200 % of the initial limit		
	Leakage current	Within the initial limit		
ESR after endurance (Ω / 100 kHz)(-40 °C)	Size code			
	F	G		
		0.4	0.3	
Shelf life	After storage for 1000 hours at +125 °C ± 2 °C with no voltage applied and then being stabilized at +20 °C, capacitors shall meet the limits specified in endurance. (With voltage treatment)			
Damp heat (Load)	+85 °C ± 2 °C, 85 % to 90 %RH, 2000 h, rated voltage applied			
	Capacitance change	Within ±30% of the initial value		
	Dissipation factor (tan δ)	≤ 200 % of the initial limit		
	ESR	≤ 200 % of the initial limit		
Leakage current	Within the initial limit			
Resistance to soldering heat	After flow soldering and then being stabilized at +20 °C, capacitors shall meet the following limits.			
	Capacitance change	Within ±10% of the initial value		
	Dissipation factor (tan δ)	Within the initial limit		
Leakage current	Within the initial limit			

**Marking**

Example : 25 V 330 µF  
Marking color : BLACK

Negative polarity marking (-)

Capacitance (µF)

Series identification

Rated voltage code

Lot number

R.voltage code	Unit : V
E	25
V	35

**Dimensions (not to scale)**

Size code	øD	L	ød	F	P1
F	8.0	9.5	0.6	3.5±0.5	4.60±0.50
G	10.0	9.5	0.6	5.0 <sup>+0.8</sup> <sub>-0.2</sub>	3.85±0.50

Unit : mm

## Characteristics list

Endurance : 125 °C 4000 h

Rated voltage (V)	Capacitance (±20 %) (μF)	Case size (mm)			Size code	Specification			Part number	Min. packaging q'ty (pcs)
		øD	L	ød		Ripple current <sup>*1</sup> (mA rms)	ESR <sup>*2</sup> (mΩ)	tan δ <sup>*3</sup>		Taping
25	330	8.0	9.5	0.6	F	2000	27	0.14	EEHAZKE331UB	1000
	560	10.0	9.5	0.6	G	2800	20	0.14	EEHAZKE561UB	500
35	220	8.0	9.5	0.6	F	2000	27	0.12	EEHAZKV221UB	1000
	390	10.0	9.5	0.6	G	2800	20	0.12	EEHAZKV391UB	500

\*1: Ripple current (100 kHz / +125 °C)

\*2: ESR (100 kHz / +20 °C)

\*3: tan δ (120 Hz / +20 °C)

◆ Please refer to the page of "Flow soldering profile" and "The taping dimensions".

## Frequency correction factor for ripple current

Frequency (f)	100 Hz ≤ f < 120 Hz	120 Hz ≤ f < 200 Hz	200 Hz ≤ f < 300 Hz	300 Hz ≤ f < 500 Hz
Correction factor	0.15	0.20	0.25	0.30
Frequency (f)	500 Hz ≤ f < 1 kHz	1 kHz ≤ f < 2 kHz	2 kHz ≤ f < 3 kHz	3 kHz ≤ f < 5 kHz
Correction factor	0.40	0.50	0.60	0.65
Frequency (f)	5 kHz ≤ f < 10 kHz	10 kHz ≤ f < 15 kHz	15 kHz ≤ f < 20 kHz	20 kHz ≤ f < 30 kHz
Correction factor	0.70	0.75	0.80	0.85
Frequency (f)	30 kHz ≤ f < 40 kHz	40 kHz ≤ f < 50 kHz	50 kHz ≤ f < 100 kHz	100 kHz ≤ f < 1000 kHz
Correction factor	0.85	0.85	0.90	1.00



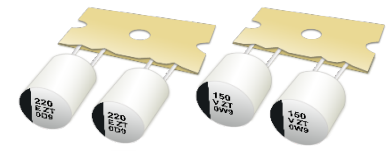

# Conductive Polymer Hybrid Aluminum Electrolytic Capacitors

## Radial Lead Type

### ZT-A series

#### Features

- Endurance : 4000 h at 125 °C (High ripple current)
- Taping products for automatic insertion
- AEC-Q200 compliant
- RoHS compliant

#### Specifications

Size code	F	G
Category temp. range	-55 °C to +125 °C	
Rated voltage range	25 V to 63 V	
Nominal cap.range	33 µF to 220 µF	56 µF to 330 µF
Capacitance tolerance	±20 % (120 Hz / +20°C)	
Leakage current	$I \leq 0.01 CV$ (µA) 2 minutes after reaching rated voltage, 20 °C *CV = (Capacitance in µF) x (Rated voltage in V)	
Dissipation factor (tan δ)	Please see the attached characteristics list	
Surge voltage (V)	Rated voltage × 1.25 (15 °C to 35 °C)	
Endurance	+125 °C ± 2 °C, 4000 h, apply the rated ripple current without exceeding the rated voltage.	
	Capacitance change	Within ±30% of the initial value
	Dissipation factor (tan δ)	≤ 200 % of the initial limit
	ESR	≤ 200 % of the initial limit
	Leakage current	Within the initial limit
ESR after endurance (Ω / 100 kHz)(-40 °C)	Size code	
	F	G
	0.4	0.3
Shelf life	After storage for 1000 hours at +125 °C ± 2 °C with no voltage applied and then being stabilized at +20 °C, capacitors shall meet the limits specified in endurance. (With voltage treatment)	
Damp heat (Load)	+85 °C ± 2 °C, 85 % to 90 %RH, 2000 h, rated voltage applied	
	Capacitance change	Within ±30% of the initial value
	Dissipation factor (tan δ)	≤ 200 % of the initial limit
	ESR	≤ 200 % of the initial limit
Leakage current	Within the initial limit	
Resistance to soldering heat	After flow soldering and then being stabilized at +20 °C, capacitors shall meet the following limits.	
	Capacitance change	Within ±10% of the initial value
	Dissipation factor (tan δ)	Within the initial limit
Leakage current	Within the initial limit	

#### Marking

Example : 25 V 220 µF

Marking color : BLACK

Negative polarity marking (-)

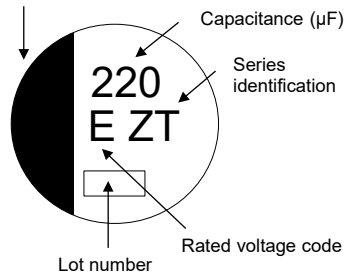

R.voltage code	Unit : V
E	25
V	35
H	50
J	63

#### Dimensions (not to scale)

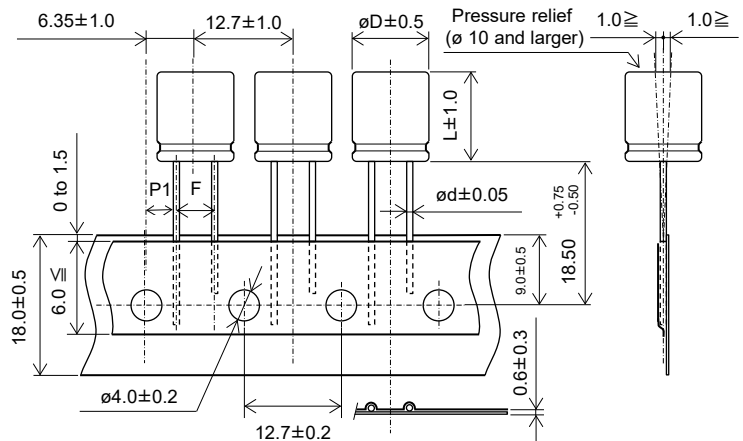

Size code	øD	L	ød	F	P1
F	8.0	9.5	0.6	3.5±0.5	4.60±0.50
G	10.0	9.5	0.6	5.0 <sup>+0.8</sup> <sub>-0.2</sub>	3.85±0.50

Unit : mm

## Characteristics list

Endurance : 125 °C 4000 h

Rated voltage (V)	Capacitance (±20 %) (μF)	Case size (mm)			Size code	Specification			Part number	Min. packaging q'ty (pcs)
		øD	L	ød		Ripple current <sup>*1</sup> (mA rms)	ESR <sup>*2</sup> (mΩ)	tan δ <sup>*3</sup>		Taping
25	220	8.0	9.5	0.6	F	2900	22	0.14	EEHAZT1E221B	1000
	330	10.0	9.5	0.6	G	3500	16	0.14	EEHAZT1E331B	500
35	150	8.0	9.5	0.6	F	2900	22	0.12	EEHAZT1V151B	1000
	270	10.0	9.5	0.6	G	3500	16	0.12	EEHAZT1V271B	500
50	68	8.0	9.5	0.6	F	2700	25	0.10	EEHAZT1H680B	1000
	100	10.0	9.5	0.6	G	2900	23	0.10	EEHAZT1H101B	500
	120	10.0	9.5	0.6	G	2900	23	0.10	EEHAZT1H121B	500
63	33	8.0	9.5	0.6	F	2400	32	0.08	EEHAZT1J330B	1000
	47	8.0	9.5	0.6	F	2400	32	0.08	EEHAZT1J470B	1000
	56	10.0	9.5	0.6	G	2800	25	0.08	EEHAZT1J560B	500
	68	10.0	9.5	0.6	G	2800	25	0.08	EEHAZT1J680B	500
	82	10.0	9.5	0.6	G	2800	25	0.08	EEHAZT1J820B	500

\*1: Ripple current (100 kHz / +125 °C)

\*2: ESR (100 kHz / +20 °C)

\*3: tan δ (120 Hz / +20 °C)

◆ Please refer to the page of "Flow soldering profile" and "The taping dimensions".

## Frequency correction factor for ripple current

Rated capacitance (C)	Frequency (f)	100 Hz ≤ f < 200 Hz	200 Hz ≤ f < 300 Hz	300 Hz ≤ f < 500 Hz	500 Hz ≤ f < 1 kHz
C < 47 μF	Correction factor	0.10	0.10	0.15	0.20
47 μF ≤ C < 150 μF		0.15	0.20	0.25	0.30
150 μF ≤ C		0.15	0.25	0.25	0.30

Rated capacitance (C)	Frequency (f)	1 kHz ≤ f < 2 kHz	2 kHz ≤ f < 3 kHz	3 kHz ≤ f < 5 kHz	5 kHz ≤ f < 10 kHz
C < 47 μF	Correction factor	0.30	0.40	0.45	0.50
47 μF ≤ C < 150 μF		0.40	0.45	0.55	0.60
150 μF ≤ C		0.45	0.50	0.60	0.65

Rated capacitance (C)	Frequency (f)	10 kHz ≤ f < 15 kHz	15 kHz ≤ f < 20 kHz	20 kHz ≤ f < 30 kHz	30 kHz ≤ f < 40 kHz
C < 47 μF	Correction factor	0.60	0.65	0.70	0.75
47 μF ≤ C < 150 μF		0.70	0.75	0.80	0.80
150 μF ≤ C		0.75	0.80	0.85	0.85

Rated capacitance (C)	Frequency (f)	40 kHz ≤ f < 50 kHz	50 kHz ≤ f < 100 kHz	100 kHz ≤ f < 500 kHz	500 kHz ≤ f < 1000 kHz
C < 47 μF	Correction factor	0.80	0.85	1.00	1.05
47 μF ≤ C < 150 μF		0.85	0.90	1.00	1.00
150 μF ≤ C		0.85	0.90	1.00	1.00

**Conductive Polymer Hybrid Aluminum Electrolytic Capacitors**  
Radial Lead Type  
**ZS-A series**

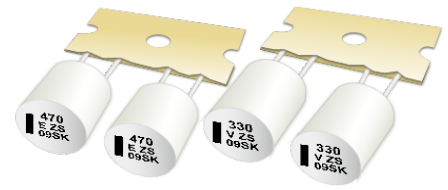

**Features**

- Endurance : 4000 h at 135 °C (Large capacitance / High ripple current / Low ESR)
- Taping products for automatic insertion
- AEC-Q200 compliant
- RoHS compliant

**Specifications**

Size code	G12	G16
Category temp. range	-55 °C to +135 °C	
Rated voltage range	25 V to 63 V	
Nominal cap.range	100 µF to 470 µF	150 µF to 560 µF
Capacitance tolerance	±20 % (120 Hz / +20°C)	
Leakage current	$I \leq 0.01 CV (\mu A)$ 2 minutes after reaching rated voltage, 20 °C *CV = (Capacitance in µF) x (Rated voltage in V)	
Dissipation factor (tan δ)	Please see the attached characteristics list	
Surge voltage (V)	Rated voltage × 1.25 (15 °C to 35 °C)	
Endurance 1	+125 °C ± 2 °C, 4000 h, apply the rated ripple current without exceeding the rated voltage.	
	Capacitance change	Within ±30% of the initial value
	Dissipation factor (tan δ)	≤ 200 % of the initial limit
	ESR	≤ 200 % of the initial limit
Endurance 2	+135 °C ± 2 °C, 4000 h, apply the rated ripple current without exceeding the rated voltage.	
	Capacitance change	Within ±30% of the initial value
	Dissipation factor (tan δ)	≤ 200 % of the initial limit
	ESR	≤ 200 % of the initial limit
Shelf life	After storage for 1000 hours at +135 °C ± 2 °C with no voltage applied and then being stabilized at +20 °C, capacitors shall meet the limits specified in endurance. (With voltage treatment)	
Damp heat (Load)	+85 °C ± 2 °C, 85 % to 90 %RH, 2000 h, rated voltage applied	
	Capacitance change	Within ±30% of the initial value
	Dissipation factor (tan δ)	≤ 200 % of the initial limit
	ESR	≤ 200 % of the initial limit
Resistance to soldering heat	After flow soldering and then being stabilized at +20 °C, capacitors shall meet the following limits.	
	Capacitance change	Within ±10% of the initial value
	Dissipation factor (tan δ)	Within the initial limit
	Leakage current	Within the initial limit

**Marking**

Example : 25 V 470 µF  
Marking color : BLACK  
Negative polarity marking (-)

Capacitance (µF)  
Series identification  
Rated voltage code

R.voltage code	Unit : V
E	25
V	35
H	50
J	63

**Dimensions (not to scale)**

Size code	øD	L	ød	F	P1
G12	10.0	11.7	0.8	5.0 <sup>+0.8</sup> <sub>-0.2</sub>	3.85±0.50
G16	10.0	15.7	0.8	5.0 <sup>+0.8</sup> <sub>-0.2</sub>	3.85±0.50

Unit : mm

## Characteristics list

Endurance 1 : 125 °C 4000 h

Endurance 2 : 135 °C 4000 h

Rated voltage (V)	Capacitance (±20 %) (μF)	Case size (mm)			Size code	Specification				Part number	Min. packaging q'ty (pcs)
		øD	L	ød		Ripple current* <sup>1</sup> (mA rms)		ESR* <sup>2</sup> (mΩ)	tan δ* <sup>3</sup>		Taping
						Endurance 1 (+125°C)	Endurance 2 (+135°C)				
25	470	10.0	11.7	0.8	G12	3500	2500	14	0.14	EEHAZS1E471B	500
	560	10.0	15.7	0.8	G16	4000	2900	11	0.14	EEHAZS1E561B	500
35	330	10.0	11.7	0.8	G12	3500	2500	14	0.12	EEHAZS1V331B	500
	470	10.0	15.7	0.8	G16	4000	2900	11	0.12	EEHAZS1V471B	500
50	150	10.0	11.7	0.8	G12	3200	2250	17	0.10	EEHAZS1H151B	500
	220	10.0	15.7	0.8	G16	3700	2600	13	0.10	EEHAZS1H221B	500
63	100	10.0	11.7	0.8	G12	3000	2100	19	0.08	EEHAZS1J101B	500
	150	10.0	15.7	0.8	G16	3500	2400	15	0.08	EEHAZS1J151B	500

\*1: Ripple current (100 kHz / +125 °C or +135 °C)

\*2: ESR (100 kHz / +20 °C)

\*3: tan δ (120 Hz / +20 °C)

◆ Please refer to the page of "Flow soldering profile" and "The taping dimensions".

## Frequency correction factor for ripple current

Rated capacitance (C)	Frequency (f)	100 Hz ≤ f < 200 Hz	200 Hz ≤ f < 300 Hz	300 Hz ≤ f < 500 Hz	500 Hz ≤ f < 1 kHz
100 μF ≤ C < 150 μF	Correction factor	0.15	0.20	0.25	0.30
150 μF ≤ C		0.15	0.25	0.25	0.30
Rated capacitance (C)	Frequency (f)	1 kHz ≤ f < 2 kHz	2 kHz ≤ f < 3 kHz	3 kHz ≤ f < 5 kHz	5 kHz ≤ f < 10 kHz
100 μF ≤ C < 150 μF	Correction factor	0.40	0.45	0.55	0.60
150 μF ≤ C		0.45	0.50	0.60	0.65
Rated capacitance (C)	Frequency (f)	10 kHz ≤ f < 15 kHz	15 kHz ≤ f < 20 kHz	20 kHz ≤ f < 30 kHz	30 kHz ≤ f < 40 kHz
100 μF ≤ C < 150 μF	Correction factor	0.70	0.75	0.80	0.80
150 μF ≤ C		0.75	0.80	0.85	0.85
Rated capacitance (C)	Frequency (f)	40 kHz ≤ f < 50 kHz	50 kHz ≤ f < 100 kHz	100 kHz ≤ f < 500 kHz	500 kHz ≤ f < 1000 kHz
100 μF ≤ C < 150 μF	Correction factor	0.85	0.90	1.00	1.00
150 μF ≤ C		0.85	0.90	1.00	1.00

**Conductive Polymer Hybrid Aluminum  
Electrolytic Capacitors**  
Radial Lead Type  
**ZSU-A series**

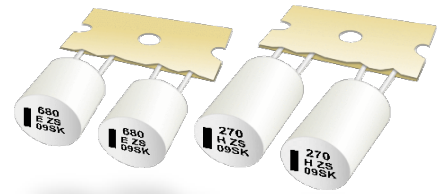

**Features**

- Endurance : 4000 h at 125 °C
- Large capacitance compared with ZS series
- Taping products for automatic insertion
- AEC-Q200 compliant
- RoHS compliant

**Specifications**

Size code	G12	G16
Category temp. range	-55 °C to +125 °C	
Rated voltage range	25 V to 63 V	
Nominal cap.range	120 µF to 680 µF	180 µF to 1000 µF
Capacitance tolerance	±20 % (120 Hz / +20°C)	
Leakage current	I ≤ 0.01 CV (µA), 2 minutes after reaching rated voltage, 20 °C *CV = (Capacitance in µF) x (Rated voltage in V)	
Dissipation factor (tan δ)	Please see the attached characteristics list	
Surge voltage (V)	Rated voltage × 1.25 (15 °C to 35 °C)	
Endurance	+125 °C ± 2 °C, 4000 h, apply the rated ripple current without exceeding the rated voltage.	
	Capacitance change	Within ±30% of the initial value
	Dissipation factor (tan δ)	≤ 200 % of the initial limit
	ESR	≤ 200 % of the initial limit
	Leakage current	Within the initial limit
ESR after endurance (Ω / 100 kHz)(-40 °C)	Size code	
	G12	G16
		0.3
Shelf life	After storage for 1000 hours at +125 °C ± 2 °C with no voltage applied and then being stabilized at +20 °C, capacitors shall meet the limits specified in endurance. (With voltage treatment)	
Damp heat (Load)	+85 °C ± 2 °C, 85 % to 90 %RH, 2000 h, rated voltage applied	
	Capacitance change	Within ±30% of the initial value
	Dissipation factor (tan δ)	≤ 200 % of the initial limit
	ESR	≤ 200 % of the initial limit
Resistance to soldering heat	After flow soldering and then being stabilized at +20 °C, capacitors shall meet the following limits.	
	Capacitance change	Within ±10% of the initial value
	Dissipation factor (tan δ)	Within the initial limit
	Leakage current	Within the initial limit

**Marking**

Example : 25 V 680 µF  
Marking color : BLACK  
Negative polarity marking (-)

Capacitance (µF)  
Series identification  
Rated voltage code  
Lot number

R.voltage code	Unit : V
E	25
V	35
H	50
J	63

**Dimensions (not to scale)**

Size code	øD	L	ød	F	P1
G12	10.0	11.7	0.8	5.0 <sup>+0.8</sup> <sub>-0.8</sub>	3.85±0.50
G16	10.0	15.7	0.8	5.0 <sup>+0.8</sup> <sub>-0.8</sub>	3.85±0.50

Unit : mm

## Characteristics list

Endurance : 125 °C 4000 h

Rated voltage (V)	Capacitance (±20 %) (μF)	Case size (mm)			Size code	Specification			Part number	Min. packaging q'ty (pcs)
		øD	L	ød		Ripple current <sup>*1</sup> (mA rms)	ESR <sup>*2</sup> (mΩ)	tan δ <sup>*3</sup>		Taping
25	680	10.0	11.7	0.8	G12	3500	14	0.14	EEHAZSE681UB	500
	1000	10.0	15.7	0.8	G16	4000	11	0.14	EEHAZSE102UB	500
35	470	10.0	11.7	0.8	G12	3500	14	0.12	EEHAZSV471UB	500
	680	10.0	15.7	0.8	G16	4000	11	0.12	EEHAZSV681UB	500
50	180	10.0	11.7	0.8	G12	3200	17	0.10	EEHAZSH181UB	500
	270	10.0	15.7	0.8	G16	3700	13	0.10	EEHAZSH271UB	500
63	120	10.0	11.7	0.8	G12	3000	19	0.08	EEHAZSJ121UB	500
	180	10.0	15.7	0.8	G16	3500	15	0.08	EEHAZSJ181UB	500

\*1: Ripple current (100 kHz / +125 °C)

\*2: ESR (100 kHz / +20 °C)

\*3: tan δ (120 Hz / +20 °C)

◆ Please refer to the page of "Flow soldering profile" and "The taping dimensions".

## Frequency correction factor for ripple current

Rated capacitance (C)	Frequency (f)	100 Hz ≤ f < 120 Hz	120 Hz ≤ f < 200 Hz	200 Hz ≤ f < 300 Hz	300 Hz ≤ f < 500 Hz
120 μF ≤ C	Correction factor	0.15	0.20	0.25	0.30
Rated capacitance (C)	Frequency (f)	500 Hz ≤ f < 1 kHz	1 kHz ≤ f < 2 kHz	2 kHz ≤ f < 3 kHz	3 kHz ≤ f < 5 kHz
120 μF ≤ C	Correction factor	0.40	0.50	0.60	0.65
Rated capacitance (C)	Frequency (f)	5 kHz ≤ f < 10 kHz	10 kHz ≤ f < 15 kHz	15 kHz ≤ f < 20 kHz	20 kHz ≤ f < 30 kHz
120 μF ≤ C	Correction factor	0.70	0.75	0.80	0.85
Rated capacitance (C)	Frequency (f)	30 kHz ≤ f < 50 kHz	50 kHz ≤ f < 100 kHz	100 kHz ≤ f < 500 kHz	500 kHz ≤ f < 1000 kHz
120 μF ≤ C	Correction factor	0.85	0.90	1.00	1.00

**Conductive Polymer Hybrid Aluminum  
Electrolytic Capacitors**  
Radial Lead Type  
**ZE-A series**



**Features**

- Endurance : 2000 h at 145 °C (High temperature / Long life)
- Taping products for automatic insertion
- AEC-Q200 compliant
- RoHS compliant

**Specifications**

Size code	F	G
Category temp. range	-55 °C to +145 °C	
Rated voltage range	25 V to 63 V	
Nominal cap.range	33 µF to 220 µF	56 µF to 330 µF
Capacitance tolerance	±20 % (120 Hz / +20°C)	
Leakage current	I ≤ 0.01 CV (µA), 2 minutes after reaching rated voltage, 20 °C *CV = (Capacitance in µF) x (Rated voltage in V)	
Dissipation factor (tan δ)	Please see the attached characteristics list	
Surge voltage (V)	Rated voltage × 1.25 (15 °C to 35 °C)	
Endurance 1	+145 °C ± 2 °C, 2000 h, apply the rated ripple current without exceeding the rated voltage.	
	Capacitance change	Within ±30% of the initial value
	Dissipation factor (tan δ)	≤ 200 % of the initial limit
	ESR	≤ 200 % of the initial limit
Endurance 2	+135 °C ± 2 °C, 4000 h, apply the rated ripple current without exceeding the rated voltage.	
	Capacitance change	Within ±30% of the initial value
	Dissipation factor (tan δ)	≤ 200 % of the initial limit
	ESR	≤ 300 % of the initial limit
Shelf life	After storage for 1000 hours at +145 °C ± 2 °C with no voltage applied and then being stabilized at +20 °C, capacitors shall meet the limits specified in endurance 1. (With voltage treatment)	
Damp heat (Load)	+85 °C ± 2 °C, 85 % to 90 %RH, 2000 h, rated voltage applied	
	Capacitance change	Within ±30% of the initial value
	Dissipation factor (tan δ)	≤ 200 % of the initial limit
	ESR	≤ 200 % of the initial limit
Resistance to soldering heat	After flow soldering and then being stabilized at +20 °C, capacitors shall meet the following limits.	
	Capacitance change	Within ±10% of the initial value
	Dissipation factor (tan δ)	Within the initial limit
	Leakage current	Within the initial limit

**Marking**

Example : 25 V 220 µF  
Marking color : BLACK

Negative polarity marking (-)

Capacitance (µF)

Series identification

Rated voltage code

Lot number

R.voltage code	Unit : V
E	25
V	35
H	50
J	63

**Dimensions (not to scale)**

Size code	øD	L	ød	F	P1
F	8.0	9.5	0.6	3.5±0.5	4.60±0.50
G	10.0	9.5	0.6	5.0 ±0.2	3.85±0.50

Unit : mm

## Characteristics list

Endurance 1 : 145 °C 2000 h

Endurance 2 : 135 °C 4000 h

Rated voltage (V)	Capacitance (±20 %) (μF)	Case size (mm)			Size code	Specification				Part number	Min. packaging q'ty (pcs)
		øD	L	ød		Ripple current *1 (mA rms)		ESR*2 (mΩ)	tan δ*3		Taping
						Endurance 1 (+145 °C)	Endurance 2 (+135 °C)				
25	220	8.0	9.5	0.6	F	700	1600	27	0.14	EEHAZE1E221B	1000
	330	10.0	9.5	0.6	G	900	2000	20	0.14	EEHAZE1E331B	500
35	150	8.0	9.5	0.6	F	700	1600	27	0.12	EEHAZE1V151B	1000
	270	10.0	9.5	0.6	G	900	2000	20	0.12	EEHAZE1V271B	500
50	68	8.0	9.5	0.6	F	600	1250	30	0.10	EEHAZE1H680B	1000
	100	10.0	9.5	0.6	G	800	1600	28	0.10	EEHAZE1H101B	500
63	33	8.0	9.5	0.6	F	600	1100	40	0.08	EEHAZE1J330B	1000
	56	10.0	9.5	0.6	G	800	1400	30	0.08	EEHAZE1J560B	500
	82	10.0	9.5	0.6	G	800	1400	30	0.08	EEHAZE1J820B	500

\*1: Ripple current (100 kHz / +145 °C or +135 °C)

\*2: ESR (100 kHz / +20 °C)

\*3: tan δ (120 Hz / +20 °C)

◆ Please refer to the page of "Flow soldering profile" and "The taping dimensions".

## Frequency correction factor for ripple current

Rated capacitance (C)	Frequency (f)	100 Hz ≤ f < 200 Hz	200 Hz ≤ f < 300 Hz	300 Hz ≤ f < 500 Hz	500 Hz ≤ f < 1 kHz
C < 47 μF	Correction factor	0.10	0.10	0.15	0.20
47 μF ≤ C < 150 μF		0.15	0.20	0.25	0.30
150 μF ≤ C		0.15	0.25	0.25	0.30

Rated capacitance (C)	Frequency (f)	1 kHz ≤ f < 2 kHz	2 kHz ≤ f < 3 kHz	3 kHz ≤ f < 5 kHz	5 kHz ≤ f < 10 kHz
C < 47 μF	Correction factor	0.30	0.40	0.45	0.50
47 μF ≤ C < 150 μF		0.40	0.45	0.55	0.60
150 μF ≤ C		0.45	0.50	0.60	0.65

Rated capacitance (C)	Frequency (f)	10 kHz ≤ f < 15 kHz	15 kHz ≤ f < 20 kHz	20 kHz ≤ f < 30 kHz	30 kHz ≤ f < 40 kHz
C < 47 μF	Correction factor	0.60	0.65	0.70	0.75
47 μF ≤ C < 150 μF		0.70	0.75	0.80	0.80
150 μF ≤ C		0.75	0.80	0.85	0.85

Rated capacitance (C)	Frequency (f)	40 kHz ≤ f < 50 kHz	50 kHz ≤ f < 100 kHz	100 kHz ≤ f < 500 kHz	500 kHz ≤ f < 1000 kHz
C < 47 μF	Correction factor	0.80	0.85	1.00	1.05
47 μF ≤ C < 150 μF		0.85	0.90	1.00	1.00
150 μF ≤ C		0.85	0.90	1.00	1.00

## After endurance ESR (100 kHz, -40 °C)

Size code	F (ø8 x L9.5)	G (ø10 x L9.5)
ESR (Ω)	0.4	0.3



**Conductive Polymer Hybrid Aluminum  
Electrolytic Capacitors**  
Radial Lead Type  
**ZF-A series**

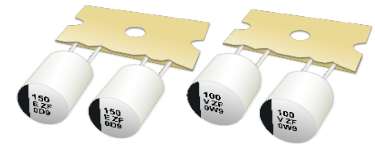

**Features**

- Endurance : 1000 h at 150 °C (High temperature)
- High temperature compared with ZC series
- High-withstand voltage (to 63 V)
- Characteristics dependencies in frequency and low temperature are as small as polymer type
- Compatible with taping products for automatic insertion
- AEC-Q200 compliant
- RoHS compliant

**Specifications**

Size code	F	G
Category temp. range	-55 °C to +150 °C	
Rated voltage range	25 V to 63 V	
Nominal cap.range	33 µF to 150 µF	56 µF to 270 µF
Capacitance tolerance	±20 % (120 Hz / +20°C)	
Leakage current	I ≤ 0.01 CV (µA), 2 minutes after reaching rated voltage, 20 °C *CV = (Capacitance in µF) x (Rated voltage in V)	
Dissipation factor (tan δ)	Please see the attached characteristics list	
Surge voltage (V)	Rated voltage × 1.25 (15 °C to 35 °C)	
Endurance	+150 °C ± 2 °C, 1000 h, apply the rated ripple current without exceeding the rated voltage.	
	Capacitance change	Within ±30% of the initial value
	Dissipation factor (tan δ)	≤ 200 % of the initial limit
	ESR	≤ 200 % of the initial limit
	Leakage current	Within the initial limit
ESR after endurance (Ω / 100 kHz)(-40 °C)	Size code	
	F	G
	0.4	0.3
Shelf life	After storage for 1000 hours at +150 °C ± 2 °C with no voltage applied and then being stabilized at +20 °C, capacitors shall meet the limits specified in endurance. (With voltage treatment)	
Damp heat (Load)	+85 °C ± 2 °C, 85 % to 90 %RH, 2000 h, rated voltage applied	
	Capacitance change	Within ±30% of the initial value
	Dissipation factor (tan δ)	≤ 200 % of the initial limit
	ESR	≤ 200 % of the initial limit
Resistance to soldering heat	After flow soldering and then being stabilized at +20 °C, capacitors shall meet the following limits.	
	Capacitance change	Within ±10% of the initial value
	Dissipation factor (tan δ)	Within the initial limit
	Leakage current	Within the initial limit

**Marking**

Example : 25 V 150 µF  
Marking color : BLACK

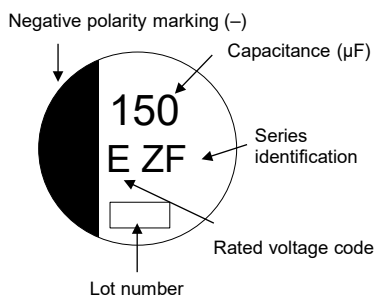

R. voltage code	Unit : V
E	25
V	35
H	50
J	63

**Dimensions (not to scale)**

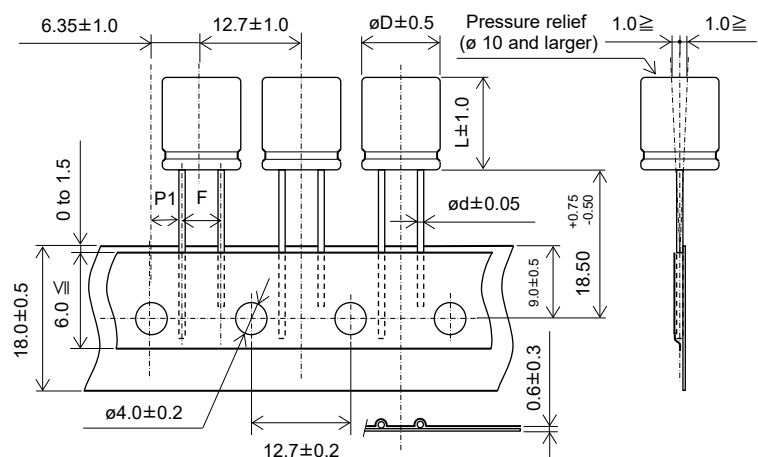

Size code	øD	L	ød	F	P1	Unit : mm
F	8.0	9.5	0.6	3.5±0.5	4.60±0.50	
G	10.0	9.5	0.6	5.0 <sup>+0.5</sup> <sub>-0.2</sub>	3.85±0.50	

## Characteristics list

Endurance : 150 °C 1000 h

Rated voltage (V)	Capacitance (±20 %) (μF)	Case size (mm)			Size code	Specification			Part number	Min. packaging q'ty (pcs)
		øD	L	ød		Ripple current *1 (mA rms)	ESR*2 (mΩ)	tan δ*3		Taping
25	150	8.0	9.5	0.6	F	800	27	0.14	EEHAZF1E151B	1000
	270	10.0	9.5	0.6	G	1000	20	0.14	EEHAZF1E271B	500
35	100	8.0	9.5	0.6	F	770	30	0.12	EEHAZF1V101B	1000
	150	10.0	9.5	0.6	G	950	23	0.12	EEHAZF1V151B	500
50	56	8.0	9.5	0.6	F	700	35	0.10	EEHAZF1H560B	1000
	100	10.0	9.5	0.6	G	900	28	0.10	EEHAZF1H101B	500
63	33	8.0	9.5	0.6	F	650	40	0.08	EEHAZF1J330B	1000
	56	10.0	9.5	0.6	G	840	30	0.08	EEHAZF1J560B	500

\*1: Ripple current (100 kHz / +150 °C)

\*2: ESR (100 kHz / +20 °C)

\*3: tan δ (120 Hz / +20 °C)

◆ Please refer to the page of "Flow soldering profile" and "The taping dimensions".

## Frequency correction factor for ripple current

Rated capacitance (C)	Frequency (f)	100 Hz ≤ f < 200 Hz	200 Hz ≤ f < 300 Hz	300 Hz ≤ f < 500 Hz	500 Hz ≤ f < 1 kHz
C < 47 μF	Correction factor	0.10	0.10	0.15	0.20
47 μF ≤ C < 150 μF		0.15	0.20	0.25	0.30
150 μF ≤ C		0.15	0.25	0.25	0.30
Rated capacitance (C)	Frequency (f)	1 kHz ≤ f < 2 kHz	2 kHz ≤ f < 3 kHz	3 kHz ≤ f < 5 kHz	5 kHz ≤ f < 10 kHz
C < 47 μF	Correction factor	0.30	0.40	0.45	0.50
47 μF ≤ C < 150 μF		0.40	0.45	0.55	0.60
150 μF ≤ C		0.45	0.50	0.60	0.65
Rated capacitance (C)	Frequency (f)	10 kHz ≤ f < 15 kHz	15 kHz ≤ f < 20 kHz	20 kHz ≤ f < 30 kHz	30 kHz ≤ f < 40 kHz
C < 47 μF	Correction factor	0.60	0.65	0.70	0.75
47 μF ≤ C < 150 μF		0.70	0.75	0.80	0.80
150 μF ≤ C		0.75	0.80	0.85	0.85
Rated capacitance (C)	Frequency (f)	40 kHz ≤ f < 50 kHz	50 kHz ≤ f < 100 kHz	100 kHz ≤ f < 500 kHz	500 kHz ≤ f
C < 47 μF	Correction factor	0.80	0.85	1.00	1.05
47 μF ≤ C < 150 μF		0.85	0.90	1.00	1.00
150 μF ≤ C		0.85	0.90	1.00	1.00

## Safety Precautions

When using our products, no matter what sort of equipment they might be used for, be sure to confirm the applications and environmental conditions with our specifications in advance.

**Panasonic**  
INDUSTRY

Panasonic Industry Co., Ltd.  
Device Solutions Business Division

1006 Kadoma, Kadoma City, Osaka  
571-8506 Japan