

Vanadium Pentoxide Lithium Coin Batteries (VL Series): Individual Specifications

VL621

■ Dimensions(mm)

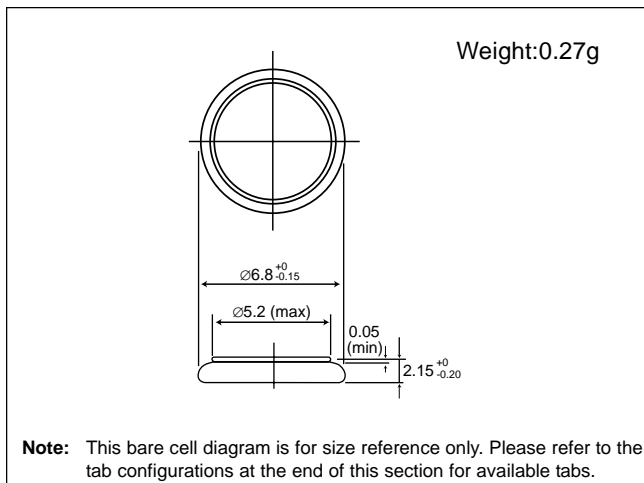

■ Specification

Nominal voltage (V)	3
Nominal capacity (mAh)	1.5
Continuous standard load (mA)	0.01
Operating temperature (C)	-20 ~ +60

■ Discharge Temperature Characteristics

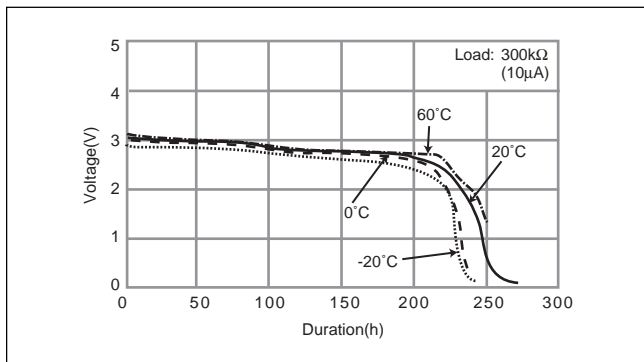

■ Consumption current vs. Duration time

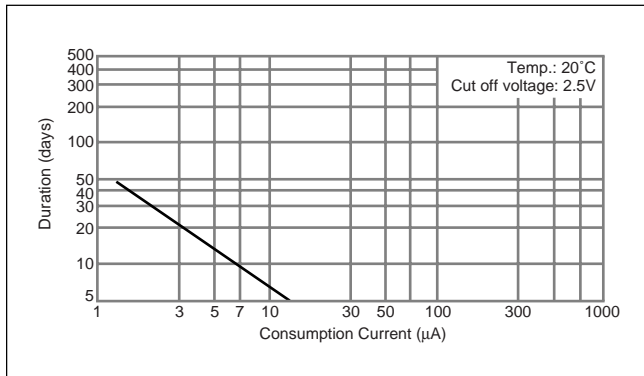

VL1220

■ Dimensions(mm)

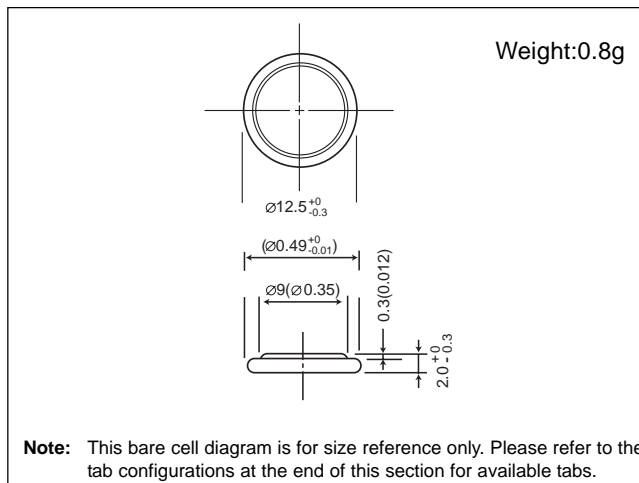

■ Specification

Nominal voltage (V)	3
Nominal capacity (mAh)	7.0
Continuous standard load (mA)	0.02
Operating temperature (C)	-20 ~ +60

■ Discharge Temperature Characteristics

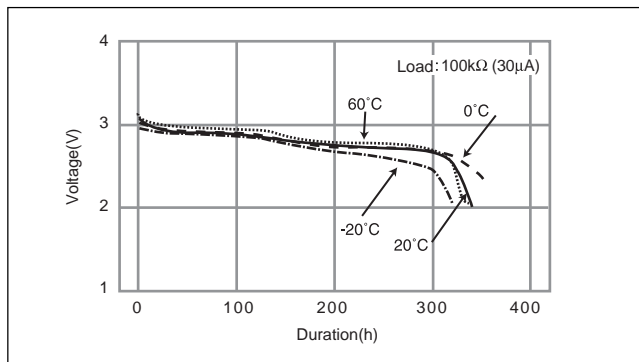

■ Consumption current vs. Duration time

