



! Partly to Be Discontinued:
TMP type
Last time buy: March 31, 2020

1 Form A 16A power relay for micro wave oven

LE RELAYS (ALE)

Protective construction : Flux-resistant type

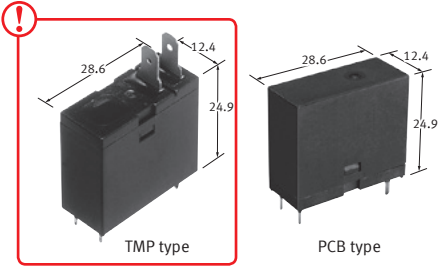

(Unit : mm)

RoHS compliant

FEATURES

- Supports magnetron and heater loads**
Capable for switching magnetron and heater loads found in microwave ovens.
- Excellent heat resistance**
Ambient temperature: up to 85°C
Certified UL coil insulation class B and class F
- Long insulation distance**
 - Creepage distance and clearances between contact and coil:
Clearance Min. 8 mm
Creepage Min. 9.5 mm
 - Surge withstand voltage: 10,000V
- Low operating power**
Rated operating power:
400mW/200mW
(High sensitive type)

- A wide variety of types**

Product line consists of 4 types with different shapes and pins

- Conforms to the various safety standards:**

UL, CSA, TÜV and VDE approved (TMP type)

UL, CSA and VDE approved (PCB type)

TYPICAL APPLICATIONS

- Microwave ovens
- Refrigerators
- OA equipment

ORDERING INFORMATION

ALE

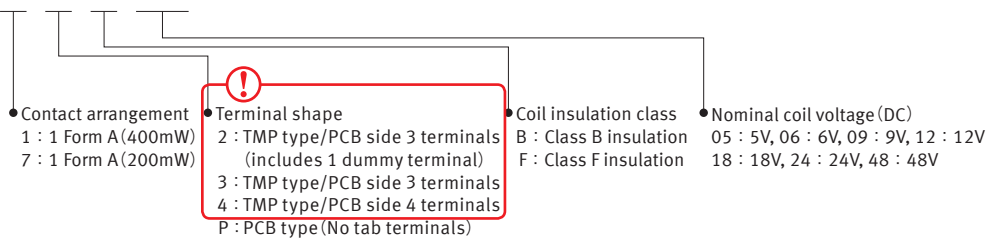

TYPES

1. Standard type

Contact arrangement	Rated voltage	TMP type			PCB type (No tab terminals)	Standard packing	
		PCB side three terminals (includes one dummy terminal)	PCB side three terminals	PCB side four terminals		Carton	Case
		Part No.	Part No.	Part No.			
1 Form A	5V DC	ALE12□05	ALE13□05	ALE14□05	ALE1P□05	100 pcs.	500 pcs.
	6V DC	ALE12□06	ALE13□06	ALE14□06	ALE1P□06		
	9V DC	ALE12□09	ALE13□09	ALE14□09	ALE1P□09		
	12V DC	ALE12□12	ALE13□12	ALE14□12	ALE1P□12		
	18V DC	ALE12□18	ALE13□18	ALE14□18	ALE1P□18		
	24V DC	ALE12□24	ALE13□24	ALE14□24	ALE1P□24		
	48V DC	ALE12□48	ALE13□48	ALE14□48	ALE1P□48		

□: Input the following letter. Class B: B, Class F: F

2. High sensitive type

Contact arrangement	Rated voltage	TMP type			PCB type (No tab terminals)	Standard packing	
		PCB side three terminals (includes one dummy terminal)	PCB side three terminals	PCB side four terminals		Carton	Case
		Part No.	Part No.	Part No.			
1 Form A (High sensitivity: 200mW)	5V DC	ALE72□05	ALE73□05	ALE74□05	ALE7P□05	100 pcs.	500 pcs.
	6V DC	ALE72□06	ALE73□06	ALE74□06	ALE7P□06		
	9V DC	ALE72□09	ALE73□09	ALE74□09	ALE7P□09		
	12V DC	ALE72□12	ALE73□12	ALE74□12	ALE7P□12		
	18V DC	ALE72□18	ALE73□18	ALE74□18	ALE7P□18		
	24V DC	ALE72□24	ALE73□24	ALE74□24	ALE7P□24		
	48V DC	ALE72□48	ALE73□48	ALE74□48	ALE7P□48		

□: Input the following letter. Class B: B, Class F: F

RATING

1. Coil data

- Operating characteristics such as 'Operate voltage' and 'Release voltage' are influenced by mounting conditions, ambient temperature, etc. Therefore, please use the relay within $\pm 5\%$ of rated coil voltage.
- 'Initial' means the condition of products at the time of delivery.

1) Standard type

Rated voltage	Operate voltage* (at 20°C)	Release voltage* (at 20°C)	Rated operating current [$\pm 10\%$] (at 20°C)	Coil resistance [$\pm 10\%$] (at 20°C)	Rated operating power	Max. allowable voltage (at 20°C)
5V DC	Max. 75%V of rated voltage (Initial)	Min. 5%V of rated voltage (Initial)	80 mA	63Ω	400mW	145%V of rated voltage
6V DC			66.7 mA	90Ω		
9V DC			44.4 mA	203Ω		
12V DC			33.3 mA	360Ω		
18V DC			22.2 mA	810Ω		
24V DC			16.7 mA	1,440Ω		
48V DC			8.3 mA	5,760Ω		

* Square, pulse drive

2) High sensitive type

Rated voltage	Operate voltage* (at 20°C)	Release voltage* (at 20°C)	Rated operating current [$\pm 10\%$] (at 20°C)	Coil resistance [$\pm 10\%$] (at 20°C)	Rated operating power	Max. allowable voltage (at 20°C)
5V DC	Max. 75%V of rated voltage (Initial)	Min. 5%V of rated voltage (Initial)	40 mA	125Ω	200mW	145%V of rated voltage
6V DC			33.3 mA	180Ω		
9V DC			22.2 mA	405Ω		
12V DC			16.7 mA	720Ω		
18V DC			11.1 mA	1,620Ω		
24V DC			8.3 mA	2,880Ω		
48V DC			4.2 mA	11,520Ω		

* Square, pulse drive

! Partly to Be Discontinued:
TMP type
Last time buy: March 31, 2020

2. Specifications

Characteristics	Item	Specifications	
Contact rating	Arrangement	1 Form A	
	Contact resistance (Initial)	Max. 100 mΩ (By voltage drop 6 V DC 1A)	
	Contact material	AgSnO ₂ type	
	Contact rating (resistive)	16A 277V AC	
	Max. switching power (resistive)	4,432VA	
	Max. switching voltage	277V AC	
	Max. switching current	16A	
	Min. switching load (reference value) ¹⁾	100mA, 5V DC	
Insulation resistance (Initial)		Min. 1,000MΩ (at 500V DC) Measurement at same location as "Dielectric strength" section.	
Dielectric strength (Initial)	Between open contacts	1,000 Vrms for 1 min. (Detection current: 10 mA)	
	Between contact and coil	4,000 Vrms for 1 min. (Detection current: 10 mA)	
Surge withstand voltage (Initial) ²⁾	Between contact and coil	10,000 V	
Time characteristics	Operate time	Max. 20 ms (at rated voltage), (at 20°C), (Initial) (excluding contact bounce time.)	
	Release time	Max. 20 ms, Max. 25 ms (200mW type) (at rated voltage), (at 20°C), (Initial) (excluding contact bounce time) (With diode)	
Mechanical characteristics	Shock resistance	Functional	200 m/s ² (Half-wave pulse of sine wave: 11 ms; detection time: 10μs.)
		Destructive	1,000 m/s ² (Half-wave pulse of sine wave: 6 ms.)
	Vibration resistance	Functional	10 to 55 Hz at double amplitude of 1.5 mm (Detection time: 10μs.)
		Destructive	10 to 55 Hz at double amplitude of 1.5 mm
Mechanical life (at 180 times/min.)		Min. 2×10 ⁶	
Conditions for operation, transport and storage ³⁾		Ambient temperature: -40°C to +85°C; Humidity: 5 to 85% R.H. (Not freezing and condensing at low temperature) Air pressure: 86 to 106 kPa	
Unit weight		Approx. 17 g, Approx. 15 g (PCB type)	

* Specifications will vary with foreign standards certification ratings.

Notes: *1. This value can change due to the switching frequency, environmental conditions, and desired reliability level, therefore it is recommended to check this with the actual load.

*2. Wave is standard shock voltage of ±1.2×50μs according to JEC-212-1981

*3. The upper limit of the ambient temperature is the maximum temperature that can satisfy the coil temperature rise value. Refer to Usage, transport and storage conditions in NOTES.

3. Electrical life

Condition: Resistive, at 20°C, at 20 times/min.

Type	Contact rating	Number of operation
1 Form A	16A 277V AC	10 ⁵

REFERENCE DATA

1.-(1) Coil temperature rise (400mW type)

Tested sample : ALE14B12, 6 pcs.
 Measured portion : Coil inside
 Ambient temperature : 25°C, 85°C

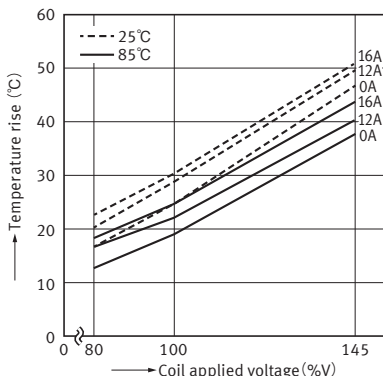

1.-(2) Coil temperature rise (200mW type)

Tested sample : ALE74B12, 6 pcs.
 Measured portion : Coil inside
 Ambient temperature : 23.7°C, 85°C

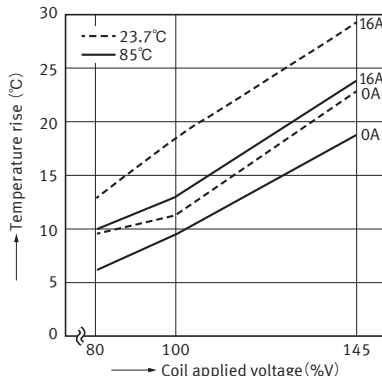

2. Life curve

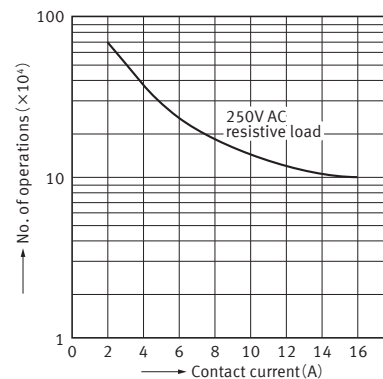

! Partly to Be Discontinued:
TMP type
Last time buy: March 31, 2020

3) PCB side four terminals

CAD Data



External dimensions

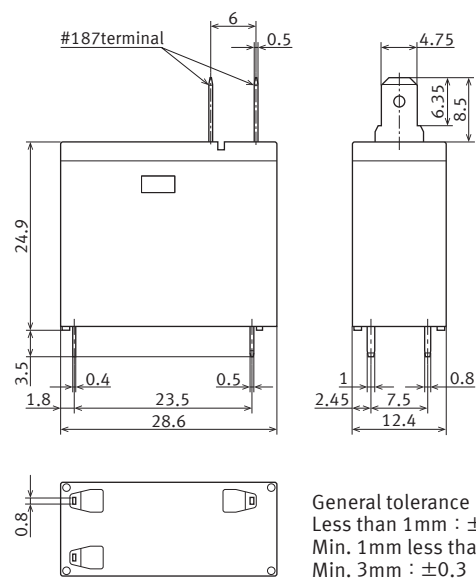

General tolerance
Less than 1mm : ± 0.1
Min. 1mm less than 3mm : ± 0.2
Min. 3mm : ± 0.3

PC board pattern (Bottom view)

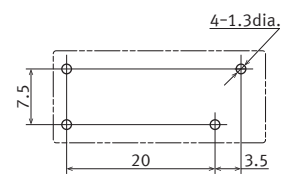

Tolerance ± 0.1

Schematic (Bottom view)

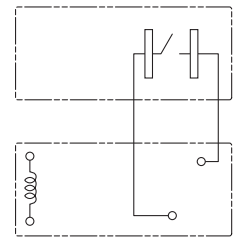

2. PCB type (No tab terminals)

CAD Data



External dimensions

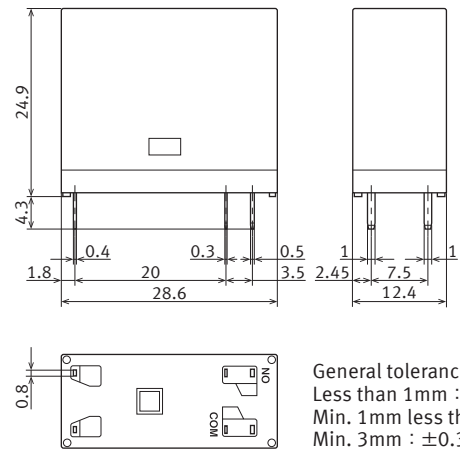

General tolerance
Less than 1mm : ± 0.1
Min. 1mm less than 3mm : ± 0.2
Min. 3mm : ± 0.3

PC board pattern (Bottom view)

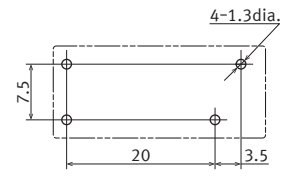

Tolerance ± 0.1

Schematic (Bottom view)



SAFETY STANDARDS

UL/C-UL

File No.	Contact rating	Cycles
E43149	16A 277V AC	10 ⁵
	16A 30 DC	10 ⁵
	18A 125V AC	6000

VDE

File No.	Contact rating
4009159	16A 250V AC (cosφ =1.0)
	16A 30V AC (0ms)

TV

File No.	Contact rating
UL: E43149	TV-5
CSA LR26550	TV-5

CSA

File No.	Contact rating
LR26550	16A 277V AC
	16A 30 DC
	18A 125V AC



TÜV

File No.	Contact rating	Cycles
B 12 06 13461 325	16A 250V AC (cosφ =1.0)	10 ⁴
	16A 30V DC (0ms)	10 ⁴

CQC

File No.	Contact rating	Temp.
CQC09002039708	16 A 250 V AC	85°C

 *1. Certified by UL/C-UL, CSA, TÜV and VDE (TMP type)

*2. Certified by UL/C-UL, CSA and VDE (PCB type)

EN/IEC VDE Certified INSULATION CHARACTERISTICS (IEC61810-1)

Item	Characteristics
Clearance/Creepage distance (IEC61810-1)	Min. 5.5mm/5.5mm
Category of protection (IEC61810-1)	RT II
Tracking resistance (IEC60112)	PTI 175
Insulation material group	III a
Over voltage category	III
Rated voltage	250V
Pollution degree	2
Type of insulation (Between contact and coil)	Reinforced insulation
Type of insulation (Between open contacts)	Micro disconnection

NOTES

1. For cautions for use, please read "GENERAL APPLICATION GUIDELINES".

https://industrial.panasonic.com/ac/e/control/relay/cautions_use/index.jsp

Please refer to "**the latest product specifications**" when designing your product.

•Requests to customers:

<https://industrial.panasonic.com/ac/e/salespolicies/>

GUIDELINES FOR POWER RELAYS AND HIGH-CAPACITY DC CUT OFF RELAYS USAGE

For cautions for use, please read “GUIDELINES FOR RELAY USAGE”.

https://industrial.panasonic.com/ac/e/control/relay/cautions_use/index.jsp

Precautions for Coil Input

■ Long term current carrying

A circuit that will be carrying a current continuously for long periods without relay switching operation. (circuits for emergency lamps, alarm devices and error inspection that, for example, revert only during malfunction and output warnings with form B contacts) Continuous, long-term current to the coil will facilitate deterioration of coil insulation and characteristics due to heating of the coil itself.

For circuits such as these, please use a magnetic-hold type latching relay. If you need to use a single stable relay, use a sealed type relay that is not easily affected by ambient conditions and make a failsafe circuit design that considers the possibility of contact failure or disconnection.

■ DC Coil operating power

Steady state DC current should be applied to the coil. The wave form should be rectangular. If it includes ripple, the ripple factor should be less than 5%.

However, please check with the actual circuit since the electrical characteristics may vary. The rated coil voltage should be applied to the coil and the set/reset pulse time of latching type relay differs for each relays, please refer to the relay's individual specifications.

■ Coil connection

When connecting coils of polarized relays, please check coil polarity (+,-) at the internal connection diagram (Schematic). If any wrong connection is made, it may cause unexpected malfunction, like abnormal heat, fire and so on, and circuit do not work. Avoid impressing voltages to the set coil and reset coil at the same time.

Ambient Environment

● Usage, Transport, and Storage Conditions

During usage, storage, or transportation, avoid locations subjected to direct sunlight and maintain normal temperature, humidity and pressure conditions.

● Temperature/Humidity/Pressure

When transporting or storing relays while they are tube packaged, there are cases the temperature may differ from the allowable range. In this case be sure to check the individual specifications. Also allowable humidity level is influenced by temperature, please check charts shown below and use relays within mentioned conditions. (Allowable temperature values differ for each relays, please refer to the relay's individual specifications.)

1) Temperature:

The tolerance temperature range differs for each relays, please refer to the relay's individual specifications

2) Humidity:

5 to 85 % RH

3) Pressure:

86 to 106 kPa

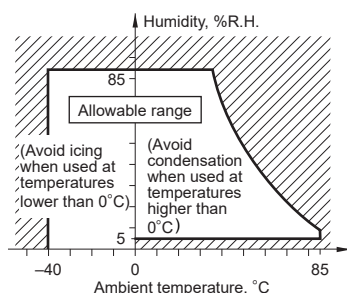

■ Maximum allowable voltage and temperature rise

Proper usage requires that the rated coil voltage be impressed on the coil. Note, however, that if a voltage greater than or equal to the maximum continuous voltage is impressed on the coil, the coil may burn or its layers short due to the temperature rise. Furthermore, do not exceed the usable ambient temperature range listed in the catalog.

■ Operate voltage change due to coil temperature rise (Hot start)

In DC relays, after continuous passage of current in the coil, if the current is turned OFF, then immediately turned ON again, due to the temperature rise in the coil, the pick-up voltage will become somewhat higher. Also, it will be the same as using it in a higher temperature atmosphere. The resistance/temperature relationship for copper wire is about 0.4% for 1°C, and with this ratio the coil resistance increases. That is, in order to operate of the relay, it is necessary that the voltage be higher than the pick-up voltage and the pick-up voltage rises in accordance with the increase in the resistance value. However, for some polarized relays, this rate of change is considerably smaller.

● Dew condensation

Condensation occurs when the ambient temperature drops suddenly from a high temperature and humidity, or the relay is suddenly transferred from a low ambient temperature to a high temperature and humidity. Condensation causes the failures like insulation deterioration, wire disconnection and rust etc. Panasonic Corporation does not guarantee the failures caused by condensation.

The heat conduction by the equipment may accelerate the cooling of device itself, and the condensation may occur.

Please conduct product evaluations in the worst condition of the actual usage. (Special attention should be paid when high temperature heating parts are close to the device. Also please consider the condensation may occur inside of the device.)

● Icing

Condensation or other moisture may freeze on relays when the temperature become lower than 0°C. This icing causes the sticking of movable portion, the operation delay and the contact conduction failure etc. Panasonic Corporation does not guarantee the failures caused by the icing.

The heat conduction by the equipment may accelerate the cooling of relay itself and the icing may occur. Please conduct product evaluations in the worst condition of the actual usage.

● Low temperature and low humidity

The plastic becomes brittle if the switch is exposed to a low temperature, low humidity environment for long periods of time.

● High temperature and high humidity

Storage for extended periods of time (including transportation periods) at high temperature or high humidity levels or in atmospheres with organic gases or sulfide gases may cause a sulfide film or oxide film to form on the surfaces of the contacts and/or it may interfere with the functions. Check out the atmosphere in which the units are to be stored and transported.

GUIDELINES FOR POWER RELAYS AND HIGH-CAPACITY DC CUT OFF RELAYS USAGE

●Package

In terms of the packing format used, make every effort to keep the effects of moisture, organic gases and sulfide gases to the absolute minimum.

●Silicon

When a source of silicone substances (silicone rubber, silicone oil, silicone coating materials and silicone filling materials etc.) is used around the relay, the silicone gas (low molecular siloxane etc.) may be produced.

This silicone gas may penetrate into the inside of the relay. When the relay is kept and used in this condition, silicone compound may adhere to the relay contacts which may cause the contact failure. Do not use any sources of silicone gas around the relay (Including plastic seal types).

●NOx Generation

When relay is used in an atmosphere high in humidity to switch a load which easily produces an arc, the NOx created by the arc and the water absorbed from outside the relay combine to produce nitric acid. This corrodes the internal metal parts and adversely affects operation. Avoid use at an ambient humidity of 85%RH or higher (at 20°C). If use at high humidity is unavoidable, please contact our sales representative.

Others

■Cleaning

- 1) Although the environmentally sealed type relay (plastic sealed type, etc.) can be cleaned, avoid immersing the relay into cold liquid (such as cleaning solvent) immediately after soldering. Doing so may deteriorate the sealing performance.
- 2) Cleaning with the boiling method is recommended(The temperature of cleaning liquid should be 40°C or lower).
Avoid ultrasonic cleaning on relays. Use of ultrasonic cleaning may cause breaks in the coil or slight sticking of the contacts due to ultrasonic energy.

Please refer to "**the latest product specifications**" when designing your product.

•Requests to customers:

<https://industrial.panasonic.com/ac/e/salespolicies/>

Please contact

Panasonic Corporation

Electromechanical Control Business Division

■ 1006, Oaza Kadoma, Kadoma-shi, Osaka 571-8506, Japan
industrial.panasonic.com/ac/e/

Panasonic[®]

©Panasonic Corporation 2019