

Microwave Devices  
**RN RELAYS**

Product Catalog

**IN Your  
Future**

# RN RELAYS

8 GHz max. capable, 150 W carrying power ( at 2 GHz ), compact SMD type, 50 Ω impedance and 1 Form C relays

Protective construction : Flux-resistant type

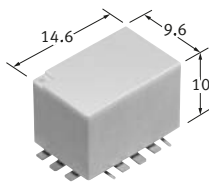

(Unit : mm)

## FEATURES

- Excellent high frequency characteristics ( 50 Ω, up to 8 GHz )
- Compact size: 9.6 ( W ) × 14.6 ( L ) × 10 ( H ) mm
- 2 GHz, 150 W carrying power possible

## TYPICAL APPLICATIONS

- Measuring equipment
- Base stations market
- High-frequency amp switching in wireless devices, etc.

Note) If you consider using applications with low level loads or with high frequency switching, please consult us.

## HIGH FREQUENCY CHARACTERISTICS

### 50 Ω ( Initial )

Frequency	Up to 1 GHz	1 to 2 GHz	2 to 3 GHz	3 to 6 GHz
V.S.W.R. ( Max. )	1.1	1.15	1.2	1.3
Insertion loss ( dB, Max. )	0.1	0.12	0.15	0.5
Isolation ( dB, Min. )	60	55	45	30

## ORDERING INFORMATION ( PART NO. )

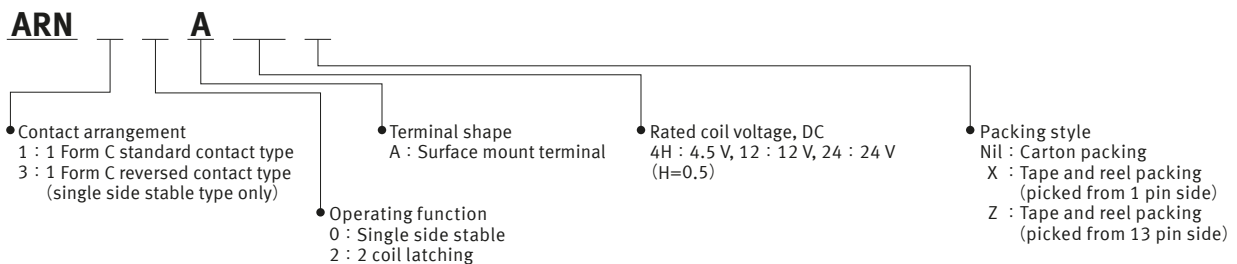

Notes : 1. Please inquire regarding use with coil voltage of 28 V DC.  
 2. Packing style symbol "X", "Z" is not marked on the relay.

# Microwave Devices RN RELAYS

## TYPES

### ■ Single side stable

#### ● Carton packing

Contact arrangement	Rated coil voltage	Part No.		Standard packing	
		Standard contact	Reverse contact	Inner carton	Outer carton
1 Form C	4.5 V DC	ARN10A4H	ARN30A4H	50 pcs.	500 pcs.
	12 V DC	ARN10A12	ARN30A12		
	24 V DC	ARN10A24	ARN30A24		

#### ● Tape and reel packing Z

Contact arrangement	Rated coil voltage	Part No.		Standard packing	
		Standard contact	Reverse contact	Inner carton (1-reel)	Outer carton
1 Form C	4.5 V DC	ARN10A4HZ	ARN30A4HZ	400 pcs.	800 pcs.
	12 V DC	ARN10A12Z	ARN30A12Z		
	24 V DC	ARN10A24Z	ARN30A24Z		

### ■ 2 coil latching

#### ● Carton packing

Contact arrangement	Rated coil voltage	Part No.		Standard packing	
		Standard contact		Inner carton	Outer carton
1 Form C	4.5 V DC	ARN12A4H		50 pcs.	500 pcs.
	12 V DC	ARN12A12			
	24 V DC	ARN12A24			

#### ● Tape and reel packing Z

Contact arrangement	Rated coil voltage	Part No.		Standard packing	
		Standard contact		Inner carton (1-reel)	Outer carton
1 Form C	4.5 V DC	ARN12A4HZ		400 pcs.	800 pcs.
	12 V DC	ARN12A12Z			
	24 V DC	ARN12A24Z			

## RATING

### ■ Coil data

- Operating characteristics such as " Operate voltage " and " Release voltage " are influenced by mounting conditions, ambient temperature, etc.  
Therefore, please use the relay within  $\pm 5\%$  of rated coil voltage.
- " Initial " means the condition of products at the time of delivery.

#### ● Single side stable

Rated coil voltage	Operate voltage* (at 20 °C)	Release voltage* (at 20 °C)	Rated operating current ( $\pm 10\%$ , at 20 °C)	Coil resistance ( $\pm 10\%$ , at 20 °C)	Rated operating power	Max. allowable voltage (at 85 °C)
4.5 V DC	Max. 75 % V of rated coil voltage ( Initial )	Min. 10 % V of rated coil voltage ( Initial )	71.1 mA	63.3 $\Omega$	320 mW	110 % V of rated coil voltage
12 V DC			26.7 mA	450 $\Omega$		
24 V DC			13.3 mA	1,800 $\Omega$		

\* square, pulse drive

#### ● 2 coil latching

Rated coil voltage	Set voltage* (at 20 °C)	Reset voltage* (at 20 °C)	Rated operating current ( $\pm 10\%$ , at 20 °C)	Coil resistance ( $\pm 10\%$ , at 20 °C)	Rated operating power	Max. allowable voltage (at 85 °C)
4.5 V DC	Max. 75 % V of rated coil voltage ( Initial )	Max. 75 % V of rated coil voltage ( Initial )	88.9 mA	50.6 $\Omega$	400 mW	110 % V of rated coil voltage
12 V DC			33.3 mA	360 $\Omega$		
24 V DC			16.7 mA	1,440 $\Omega$		

\* square, pulse drive

# Microwave Devices RN RELAYS

## Specifications

Item		Specifications
Contact data	Contact arrangement	1 Form C
	Contact resistance ( initial )	Max. 100 mΩ ( by voltage drop 10 V AC 10 mA )
	Contact material	Au plating
	Contact rating	80 W ( 2 GHz, 50 Ω, V.S.W.R.: Max. 1.15 )
	Contact input power ( CW ) *1	Max. 150 W ( at 20 °C, 2 GHz, 50 Ω, V.S.W.R.: Max. 1.15, with heat sink ) Max. 100 W ( at 20 °C, 2 GHz, 50 Ω, V.S.W.R.: Max. 1.15, without heat sink )
Insulation resistance ( initial )		Min. 1,000 MΩ ( at 500 V DC, Measured portion is the same as the case of dielectric strength. )
Dielectric strength ( initial )	Between open contacts	500 V rms for 1 min ( detection current: 10 mA )
	Between contact and coil	500 V rms for 1 min ( detection current: 10 mA )
	Between contact and ground	500 V rms for 1 min ( detection current: 10 mA )
	Between coil and ground	500 V rms for 1 min ( detection current: 10 mA )
Time characteristics ( initial )	Operate ( Set ) time	Max. 5 ms ( Max. 5 ms ) at rated coil voltage ( at 20 °C, without bounce )
	Release ( Reset ) time	Max. 5 ms ( Max. 5 ms ) at rated coil voltage ( at 20 °C, without bounce, without diode ) *2
Shock resistance	Functional	490 m/s <sup>2</sup> ( half-sine shock pulse: 11 ms, detection time: 10 μs )
	Destructive	980 m/s <sup>2</sup> ( half-sine shock pulse: 6 ms )
Vibration resistance	Functional	10 to 55 Hz ( at double amplitude of 3 mm, detection time: 10 μs )
	Destructive	10 to 55 Hz ( at double amplitude of 5 mm )
Expected life	Mechanical life ( Cold switch )	Min. 10 <sup>6</sup> ope. ( switching frequency: at 180 times/min )
Conditions	Conditions for usage, transport and storage *3	Ambient temperature: -40 to +85 °C ( Allowable temperature is from -40 to +60 °C at our standard packing condition. ) Humidity: 5 to 85 % RH ( Avoid icing and condensation )
Unit weight		Approx. 2.5 g

\*1: Since the design of the PC board and heat dispersion conditions affect contact carrying power, please verify under actual conditions.

\*2: Release time will long then if a diode, etc., is connected in parallel to the coil. Be sure to verify operation under actual conditions.

\*3: For ambient temperature, please read " GUIDELINES FOR RELAY USAGE " .

## Electrical life ( Hot switch )

Conditions: Switching frequency at 20 times/min

Type	Load	Switching capacity	Number of operations
1 Form C	Resistive load	10 mA 10 V DC	Min. 10 <sup>6</sup> ope.
	High frequency load	1 W ( 2 GHz, 50 Ω, V.S.W.R.: Max. 1.15 )	Min. 10 <sup>6</sup> ope.
		80 W ( at 20 °C, 2 GHz, 50 Ω, V.S.W.R.: Max. 1.15, with heat sink )	Min. 10 <sup>3</sup> ope. ( Switching frequency ON: OFF = 5 s : 5 s )

## REFERENCE DATA

### 1. High frequency characteristics

Sample : ARN10A12

Measuring method : See "Measuring method" under "NOTES" .

V.S.W.R. characteristics

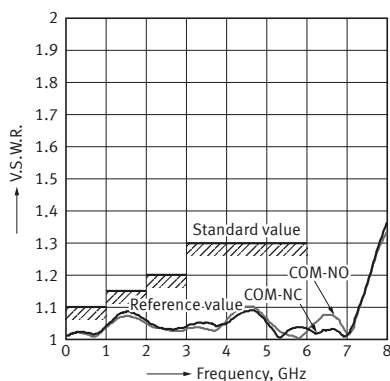

Insertion loss characteristics (without D.U.T. board's loss)

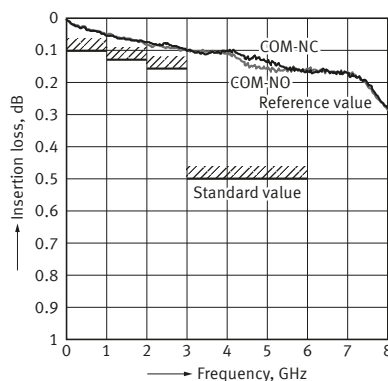

Isolation characteristics

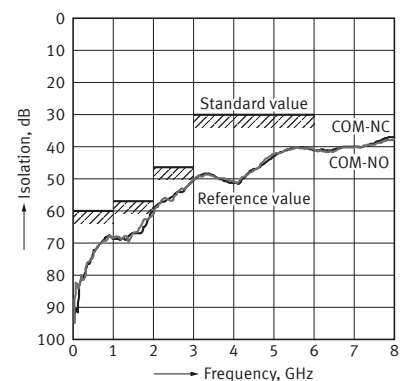

# Microwave Devices RN RELAYS

## 2. Contact input power

Max. 150 W (with heat sink)  
 (at 2 GHz, Impedance 50Ω, V.S.W.R. Max. 1.15, at 20°C)  
 Max. 100 W (without heat sink)  
 (at 2 GHz, Impedance 50Ω, V.S.W.R. Max. 1.15, at 20°C)

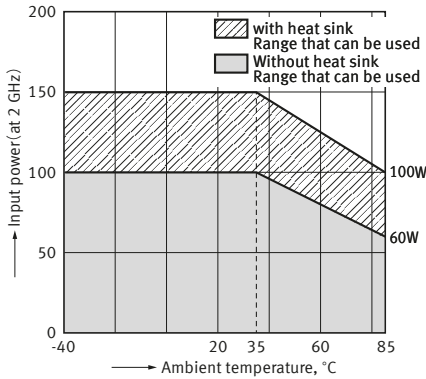

## MEASURING METHOD OF HIGH FREQUENCY CHARACTERISTICS ( Unit: mm )

### 50 Ω

#### Measuring method

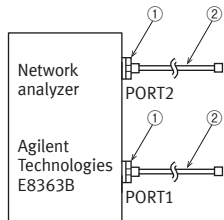

No.	Product name	Contents
1	Agilent 85130-60011	Adapter 2.4 - 3.5 mm female
2	SUHNER SUCOFLEX104	Cable 3.5 - 3.5 mm male

- 1) Connect connectors 1 and 2 respectively to PORT1 and PORT2.  
 Perform calibration using the 3.5 mm calibration kit ( HP85052B ).
- 2) After calibration, connect the D.U.T board and measure.  
 However, connectors other than those for measurement should be connected with 50 Ω termination resistor.

#### D.U.T board

Material	Glass PTFE double-sided through hole PC board R-4737 ( manufactured by our company )
Board thickness	t = 0.8 mm
Copper plating thickness	18 μm

#### Surface mount terminal

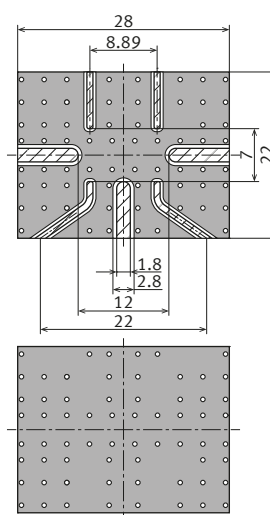

#### Calibration board

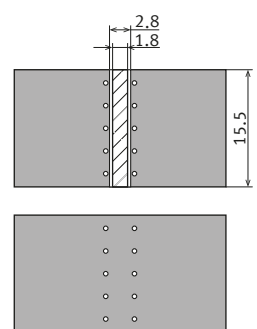

#### Connector ( SMA type )

Product name	01K1808-00 ( Waka Manufacturing Co., Ltd. )
--------------	---

#### Correction of insertion loss

The insertion loss of relay itself is given by subtracting the insertion loss of calibration board.

# Microwave Devices RN RELAYS

## DIMENSIONS ( Unit: mm )

**CAD** The CAD data of the products with a " CAD " mark can be downloaded from our Website.

### ■ Surface mount terminal

● 50 Ω

### **CAD**

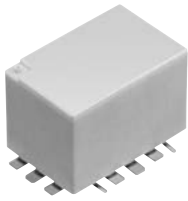

External dimensions

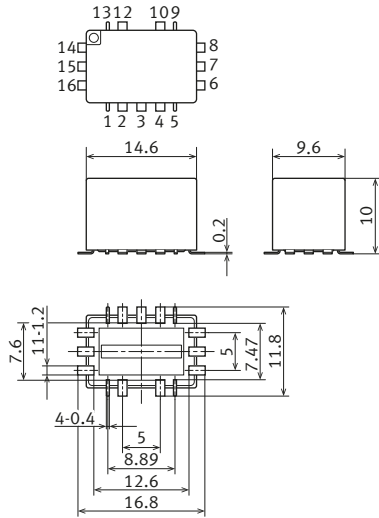

General tolerance : ±0.3

Recommended PC board pattern ( TOP VIEW )

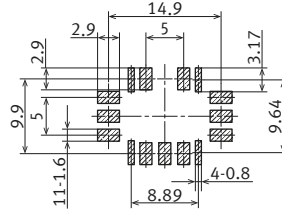

Tolerance : ±0.1

Schematic ( TOP VIEW )  
Single side stable  
Standard contact  
( De-energize )

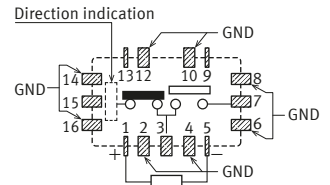

Reverse contact  
( De-energize )

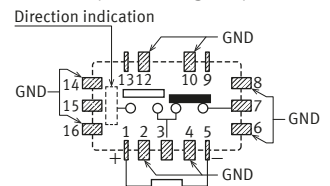

2 coil latching  
Standard contact  
( Reset )

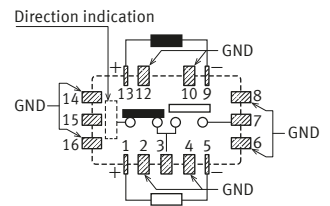

# Microwave Devices RN RELAYS

## OPTION ( Unit: mm )

### Heat sink ( AQP812 )

CAD



External dimensions

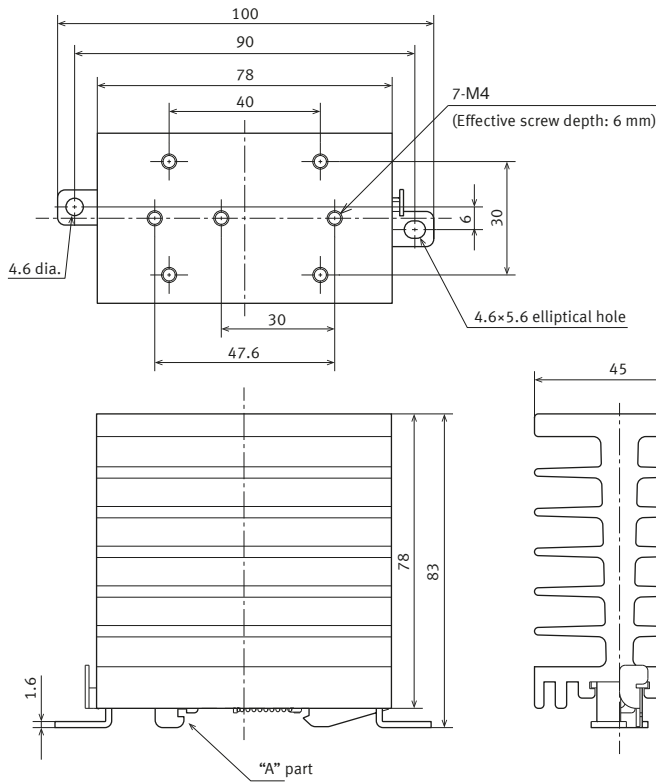

Recommended PC board pattern

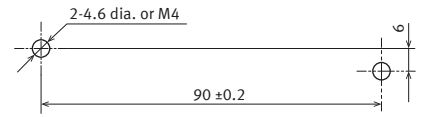

Note: When using on a DIN rail, please install so that the "A" part is on top. General tolerance: ±1.0

# Microwave Devices RN RELAYS

## PACKING SPECIFICATION ( Unit: mm )

### Tape and reel packing

#### 1) Tape dimensions

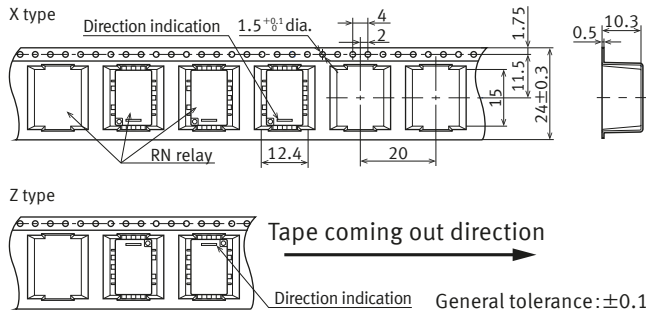

#### 2) Dimensions of plastic reel

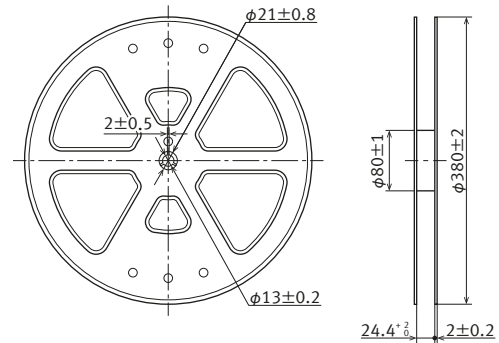

#### 3) Ambient temperature when transporting and during storage with the product in its our standard packaging: -40 to +60 °C

## EXAMPLE FOR RECOMMENDED SOLDERING CONDITION

### For cautions for use, please read " SMT Soldering Guidelines " .

#### Surface mount terminal

In case of automatic soldering ( reflow ), the following conditions should be observed.

#### ● IRS ( infrared reflow soldering method ) heating conditions

Recommended condition	
The number of reflow operation	1 time
Measurement area	Surface of PC board where relay is mounted

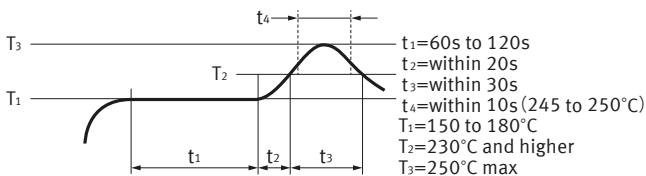

#### Measuring position of temperature profile

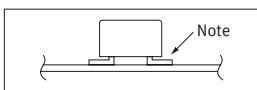

Note : The soldering temperature profile indicates the pad temperature. In some cases, the ambient temperature may be greatly increased. Check for the specific mounting condition.

#### ● Mounting cautions

Cautions to observe when mounting temperature increases in the relay are greatly dependent on the way different parts are located a PC board and the heating method of the reflow device. Therefore, please conduct testing on the actual device beforehand after making sure the parts soldered on the relay terminals and the top of the relay case are within the temperature conditions.

#### Other things to observe

- Exceeding the stipulated conditions when soldering may affect coaxial switch performance. Be sure to consult us beforehand.
- Since thermal stress on a relay will depend on the PC board and process conditions, please be sure to test using the actual PC board.
- Creep-up, wettability and solder strength will differ depending on changes in the mounting conditions and type of solder. Please evaluate based on actual production conditions.
- This relay is a flux-resistant type. Do not allow coating material to adhere to the relay as doing so may cause it to enter inside the relay and cause contact malfunction. To avoid this, you can install the relay afterwards.



# Microwave Devices RN RELAYS

## GUIDELINES FOR USAGE

■ For cautions for use, please read " GUIDELINES FOR MICROWAVE DEVICES USAGE " and " GUIDELINES FOR RELAY USAGE "

### ■ Cautions for usage of RN relays

#### ● Latching

- We recommend latching type when using in applications which involve lengthy duty cycles.
- Regarding the set and reset pulse time, for the purpose of reliable operation under ambient temperature fluctuations and different operating conditions, we recommend setting the coil applied set and reset pulse time to 30 ms or more at the rated coil voltage.
- The latching type relay is shipped in the reset position. But jolts during transport or impacts during installation can change the reset position. It is, therefore, advisable to build a circuit in which the relay can be initialized ( set and reset ) just after turning on the power.

#### ● External magnetic field

- Since RN relays are highly sensitive polarized relays, their characteristics will be affected by a strong external magnetic field. Avoid using the relay under that condition.

## CONDITIONS FOR USE

### ■ Conditions for use, transportation and storage

During usage, storage, or transportation, avoid locations subject to direct sunlight and maintain normal temperature, humidity, and pressure conditions.

#### ● Temperature and humidity

When transporting or storing relays while they are tube packaged, there are cases when the temperature may differ from the allowable range. In this situation, be sure to consult the individual specifications.

The humidity range varies with the temperature. Use within the range indicated in the graph. ( The allowable temperature depends on the relays. )

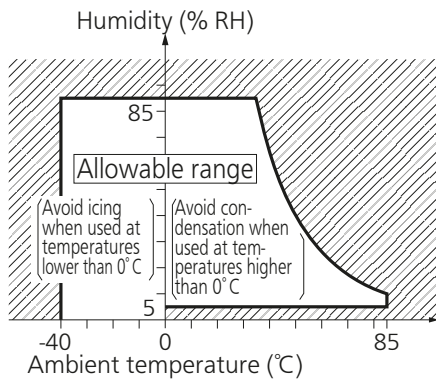

# GUIDELINES FOR MICROWAVE DEVICES USAGE

- For cautions for use, please read " GUIDELINES FOR RELAY USAGE ".  
[https://industrial.panasonic.com/ac/e/control/relay/cautions\\_use/index.jsp](https://industrial.panasonic.com/ac/e/control/relay/cautions_use/index.jsp)

## Precautions for Coil Input

### ■ Long term current carrying

A circuit that will be carrying a current continuously for long periods without relay or microwave device switching operation.

( circuits for emergency lamps, alarm devices and error inspection that, for example, revert only during malfunction and output warnings with form B contacts ) Continuous, long-term current to the coil will facilitate deterioration of coil insulation and characteristics due to heating of the coil itself.

For circuits such as these, please use a magnetic-hold type latching relay. If you need to use a single stable relay, use a sealed type relay that is not easily affected by ambient conditions and make a failsafe circuit design that considers the possibility of contact failure or disconnection.

### ■ DC Coil operating power

Steady state DC current should be applied to the coil. The wave form should be rectangular. If it includes ripple, the ripple factor should be less than 5 %.

However, please check with the actual circuit since the electrical characteristics may vary. The rated coil voltage should be applied to the coil and the set/reset pulse time of latching type relay differs for each relay, please refer to the relay's individual specifications.

### ■ Coil connection

When connecting coils of polarized relays, please check coil polarity ( +, - ) at the internal connection diagram ( Schematic ). If any wrong connection is made, it may cause unexpected malfunction, like abnormal heat, fire and so on, and circuit do not work. Avoid impressing voltages to the set coil and reset coil at the same time.

### ■ Maximum allowable voltage and temperature rise

Proper usage requires that the rated coil voltage be impressed on the coil. Note, however, that if a voltage greater than or equal to the maximum continuous voltage is impressed on the coil, the coil may burn or its layers short due to the temperature rise. Furthermore, do not exceed the usable ambient temperature range listed in the catalog.

#### ● Maximum allowable voltage for coil

In addition to being a requirement for relay operation stability, the maximum continuous impressed coil voltage is an important constraint for the prevention of such problems as thermal deterioration or deformity of the insulation material, or the occurrence of fire hazards.

#### ● Operate voltage change due to coil temperature rise ( Hot start )

In DC relays, after continuous passage of current in the coil, if the current is turned OFF, then immediately turned ON again, due to the temperature rise in the coil, the operate voltage will become somewhat higher. Also, it will be the same as using it in a higher temperature atmosphere. The resistance/temperature relationship for copper wire is about 0.4 % for 1 °C, and with this ratio the coil resistance increases. That is, in order to operate of the relay, it is necessary that the voltage be higher than the operate voltage and the operate voltage rises in accordance with the increase in the resistance value. However, for some polarized relays, this rate of change is considerably smaller.

## Ambient Environment

### ● Dew condensation

Condensation occurs when the ambient temperature drops suddenly from a high temperature and humidity, or the relay and microwave device is suddenly transferred from a low ambient temperature to a high temperature and humidity. Condensation causes the failures like insulation deterioration, wire disconnection and rust etc. Panasonic Industry Co., Ltd. does not guarantee the failures caused by condensation.

The heat conduction by the equipment may accelerate the cooling of device itself, and the condensation may occur.

Please conduct product evaluations in the worst condition of the actual usage. ( Special attention should be paid when high temperature heating parts are close to the device. Also please consider the condensation may occur inside of the device. )

### ● Icing

Condensation or other moisture may freeze on relays when the temperature become lower than 0 °C. This icing causes the sticking of movable portion, the operation delay and the contact conduction failure etc. Panasonic Industry Co., Ltd. does not guarantee the failures caused by the icing.

The heat conduction by the equipment may accelerate the cooling of relay itself and the icing may occur. Please conduct product evaluations in the worst condition of the actual usage.

### ● Low temperature and low humidity

The plastic becomes brittle if the switch is exposed to a low temperature, low humidity environment for long periods of time.

### ● High temperature and high humidity

Storage for extended periods of time ( including transportation periods ) at high temperature or high humidity levels or in atmospheres with organic gases or sulfide gases may cause a sulfide film or oxide film to form on the surfaces of the contacts and/or it may interfere with the functions. Check out the atmosphere in which the units are to be stored and transported.

### ● Package

In terms of the packing format used, make every effort to keep the effects of moisture, organic gases and sulfide gases to the absolute minimum.

### ● Storage requirements

Since the surface-mount terminal type is sensitive to humidity it is packaged with tightly sealed anti-humidity packaging. However, when storing, please be careful of the following.

1) Please use promptly once the anti-humidity pack is opened. ( within 72 hours, Max. 30 °C/70 % RH ). If left with the pack open, the relay will absorb moisture which will cause thermal stress when reflow mounting and thus cause the case to expand. As a result, the seal may break.

2) If relays will not be used within 72 hours, please store relays in a humidity controlled desiccator or in an anti-humidity bag to which silica gel has been added.

Note) If the relay is to be soldered after it has been exposed to excessive humidity atmosphere, cracks and leaks can occur. Be sure to mount the relay under the required mounting conditions.

3) The following cautionary label is affixed to the anti-humidity pack.

**C a u t i o n**

This vacuum-sealed bag contains

**Moisture Sensitive Products**

After this bag is opened, the product must be used

**within 7 2 h o u r s**

If product is not used within 72 hours, baking is necessary.  
For baking conditions please contact us.

# GUIDELINES FOR MICROWAVE DEVICES USAGE

## ● Silicon

When a source of silicone substances ( silicone rubber, silicone oil, silicone coating materials and silicone filling materials etc. ) is used around the relay, the silicone gas ( low molecular siloxane etc. ) may be produced. This silicone gas may penetrate into the inside of the relay. When the relay is kept and used in this condition, silicone compound may adhere to the relay contacts which may cause the contact failure. Do not use any sources of silicone gas around the relay ( Including plastic sealed types ).

## ● NOx Generation

When relay is used in an atmosphere high in humidity to switch a load which easily produces an arc, the NOx created by the arc and the water absorbed from outside the relay combine to produce nitric acid. This corrodes the internal metal parts and adversely affects operation. Avoid use at an ambient humidity of 85 %RH or higher ( at 20 °C ). If use at high humidity is unavoidable, please contact our sales representative.

## Others

### ■ Cleaning

- Although the environmentally sealed type relay ( plastic sealed type, etc. ) can be cleaned, avoid immersing the relay into cold liquid ( such as cleaning solvent ) immediately after soldering. Doing so may deteriorate the sealing performance.
- Surface-mount terminal type relay is sealed type and it can be cleaned by immersion. Use pure water or alcohol-based cleaning solvent.
- Cleaning with the boiling method is recommended ( The temperature of cleaning liquid should be 40 °C or lower ). Avoid ultrasonic cleaning on relays. Use of ultrasonic cleaning may cause breaks in the coil or slight sticking of the contacts due to the ultrasonic energy.

Please refer to "the latest product specifications" when designing your product.  
• Requests to customers:  
<https://industrial.panasonic.com/ac/e/salespolicies/>

■ Global Sales Network Information: [industrial.panasonic.com/ac/e/salesnetwork](https://industrial.panasonic.com/ac/e/salesnetwork)

---

**Panasonic**  
INDUSTRY

**Panasonic Industry Co., Ltd.**

Electromechanical Control Business Division

■ 1006, Oaza Kadoma, Kadoma-shi, Osaka 571-8506, Japan  
[industrial.panasonic.com/ac/e/](https://industrial.panasonic.com/ac/e/)