

Interface Terminal

# RT-3 UNIT RELAY

( PA-N relay type )

# /4-POINT TERMINAL

( Without relay type )

## Product Catalog

"PhotoMOS", "PhotoMOS" and "PHOTOMOS" are registered trademarks of Panasonic Holdings Corporation.  
Recognized in Japan, the United States, all member states of European Union and the other countries.

**IN Your  
Future**

# RT-3 UNIT RELAY ( PA-N relay type ) / 4-POINT TERMINAL ( Without relay type )

Mix mechanical relays and PhotoMOS in accordance with your application.

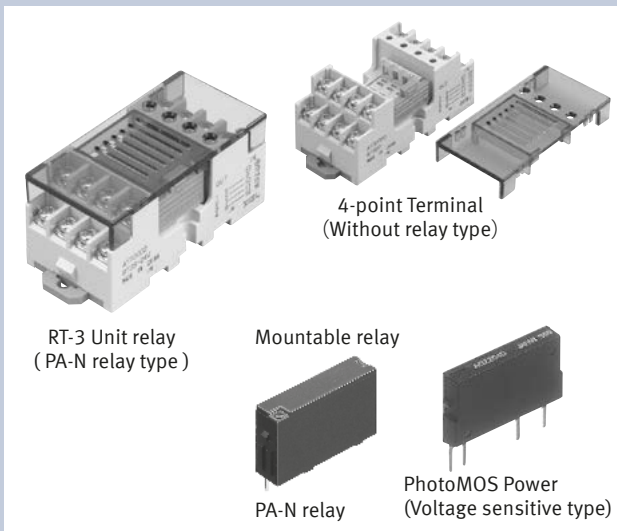

## FEATURES

- Slim shape with width of 33 mm
- Can be mounted on a DIN rail or mounted directly by screw.
- Equipped with an LED display to allow easy confirmation of operation.
- Possible to select a relay for use in the 4-point terminal in accordance with its load.

## TYPES

" Type No. " is ordering part number for non Japanese market. " Part No. " is ordering part number for Japanese market.

### RT-3 Unit relay ( PA-N relay type )

Contact arrangement	Rated input voltage	Type No.	Part No.	Standard packing	
				Inner carton	Outer carton
1 Form A × 4	12 V DC	RT3SN-12V	AY32001	1 pc.	20 pcs.
	24 V DC	RT3SN-24V	AY32002		

Note) 4 pieces PA-N relays are installed.

### 4-point Terminal ( Without relay type )

Type	Rated input voltage	Type No.	Part No.	Standard packing	
				Inner carton	Outer carton
Without relay type	12V, 24V DC	RT3BB	AY30000	1 pc.	20 pcs.

Note) Relay sold separately. Please refer to the following for the relays that can be mounted.

### Mountable relays for 4-point Terminal

Product name	Part No.
PA-N relay	APAN3112, APAN3124
PhotoMOS	AQZ10*D ( DC only type )
Power voltage sensitive type	AQZ20*D ( AC/DC dual use type )

Notes) 1: Never install relays into this product other than those given above. Doing so will cause malfunction, breakdown, and breakdown of the connected product.  
2: Cannot be equipped with PhotoMOS Power standard type relays. However, equipping with power voltage sensitive type is possible.

# RT-3 UNIT RELAY ( PA-N relay type ) /4-POINT TERMINAL ( Without relay type )

## RATING

### RT-3 Unit relay

#### 1) Input rating ( per relay )

Part No.	Rated input voltage	Input current (at rated input voltage) ( at 20 °C )	Allowable variation of rated input voltage ( -20 to +55 °C )
AY32001	12 V DC	Approx. 10.7 mA ( Relay 9.2 mA + LED 1.5 mA )	12 V DC ±10 %
AY32002	24 V DC	Approx. 7.6 mA ( Relay 4.6 mA + LED 3.0 mA )	24 V DC ±10 %

#### 2) PA-N relay coil specifications ( Reference value )

Relay part No.	Operate voltage ( at 20 °C )	Release voltage ( at 20 °C )	Coil resistance [ ±10 % ] ( at 20 °C )	Rated operating power
APAN3112	Max. 70 % V of rated coil voltage ( Initial )	Min. 5 % V of rated coil voltage ( Initial )	1,309 Ω	110 mW
APAN3124			5,236 Ω	110 mW

#### 3) Output rating ( per relay )

Specifications	Item	Specifications
Contact data	Contact rating ( resistive )	3 A 250 V AC, 3 A 30 V DC
	Max. switching power ( resistive )	750 VA ( AC ) , 90 W ( DC )
	Max. switching voltage	250 V AC, 30 V DC
	Max. switching current	3 A
	Min. switching load ( reference value )	100 μA 100 mV DC
Expected life	Mechanical life	Min. 20 × 10 <sup>6</sup> ope. ( at 180 times/min )
	Electrical life ( resistive )	3 A 250 V AC: Min. 30 × 10 <sup>3</sup> ope. , 3 A 30 V DC: Min. 30 × 10 <sup>3</sup> ope. 2 A 250 V AC: Min. 100 × 10 <sup>3</sup> ope. , 2 A 30 V DC: Min. 100 × 10 <sup>3</sup> ope.

Note) During 4-point simultaneous operation, the rating per point is also as shown above.

# RT-3 UNIT RELAY ( PA-N relay type ) /4-POINT TERMINAL ( Without relay type )

## ■ 4-point Terminal

### 1) Input ratings ( per relay )

Rated input voltage	Allowable variation of rated input voltage	Allowable input current
12 V, 24 V DC	12 V DC $\pm 10\%$ , 24 V DC $\pm 10\%$	0.2 A

Note) The input current value above is the allowable value when no relay is installed.  
Please note that input current is determined by the type of relay installed.

### 2) Input rating when PA-N relay installed ( per relay, at 20 °C )

Type	Rated input voltage	Operate voltage ( Initial )	Release voltage ( Initial )	Input current ( during application of rated input voltage )
APAN3112	12 V DC	Max. 9.5 V DC ( Relay max. 8.4 V + include diode max. 1.1 V )	Min. 1.0 V DC ( Relay min. 0.6 V + include diode min. 0.4 V )	Approx. 10.7 mA ( Relay 9.2 mA + LED 1.5 mA )
APAN3124	24 V DC	Max. 17.9V DC ( Relay max. 16.8 V + include diode max. 1.1 V )	Min. 1.6 V DC ( Relay min. 1.2 V + include diode min. 0.4 V )	Approx. 7.6 mA ( Relay 4.6 mA + LED 1.5 mA )

### 3) Input rating when PhotoMOS Power voltage sensitive type installed ( per relay, at 25 °C )

Type	Rated input voltage	Operate voltage ( Initial )	Release voltage ( Initial )	Input current ( during application of rated input voltage )
AQZ*0*D	12 V, 24 V DC	Max. 5.1 V DC ( Relay max. 4.0 V + include diode max. 1.1 V )	Min. 1.2 V DC ( Relay min. 0.8 V + include diode min. 0.4 V )	Approx. 10.0 mA ( Relay 7.0 mA + LED 3.0 mA )

### 4) Output rating ( per relay )

Allowable load voltage	Allowable load current
600 V ( DC ), 600 V ( AC peak value )	3 A

Notes) The value above is the allowable value when no relay is installed.  
Please note that limitations apply to the load voltage and current depending on the type of relay installed.

### 5) Output rating when PA-N relay installed ( per relay, at 20 °C )

Specifications	Item	Specifications
Contact data	Contact rating ( resistive )	3 A 250 V AC, 3 A 30 V DC
	Max. switching power ( resistive )	750 VA ( AC ), 90 W ( DC )
	Max. switching voltage	250 V AC, 30 V DC
	Max. switching current	3 A
	Min. switching load ( reference value )	100 $\mu$ A 100 mV DC
Expected life	Mechanical life	Min. 20 $\times 10^6$ ope. ( at 180 times/min )
	Electrical life ( resistive )	3 A 250 V AC, 3 A 30 V DC: Min. 30 $\times 10^3$ ope. 2 A 250 V AC, 2 A 30 V DC: Min. 100 $\times 10^3$ ope.

Note) During 4-point simultaneous operation, the rating per point is also as shown above.

### 6) Output rating when PhotoMOS Power voltage sensitive type installed ( per relay, at 25 °C )

Mountable relays		Maximum load voltage ( DC, AC peak value )	Continuous load current ( DC, AC peak value )
Type	Part No.		
DC only	AQZ102D	60 V	1.80 A
	AQZ105D	100 V	1.15 A
	AQZ107D	200 V	0.55 A
	AQZ104D	400 V	0.30 A
AC, DC dual use	AQZ202D	60 V	1.350 A
	AQZ205D	100 V	0.900 A
	AQZ207D	200 V	0.450 A
	AQZ204D	400 V	0.225 A

Note) During 4-point simultaneous operation, the rating per point is also as shown above.  
Please use a load current that is within the range of the data given below in " REFERENCE DATA Load current vs. ambient temperature characteristics " .

# RT-3 UNIT RELAY ( PA-N relay type ) /4-POINT TERMINAL ( Without relay type )

## SPECIFICATIONS

### RT-3 Unit relay/4-point Terminal

Item		Specifications	Conditions
Dielectric strength ( initial )	Between input and output	2,000 V AC	for 1 min
	Between different terminals ( between relays, both ways )	1,500 V AC	for 1 min
Insulation resistance		Min. 100 MΩ ( Measured portion is the same as the case of dielectric strength. )	Using 500 V DC megger
Shock resistance	Destructive	Min. 196 m/s <sup>2</sup>	In vertical, horizontal and longitudinal directions
	Functional	Min. 98 m/s <sup>2</sup>	In vertical, horizontal and longitudinal directions
Vibration resistance	Destructive	10 to 55 Hz at double amplitude of 1 mm	In vertical, horizontal and longitudinal directions
	Functional	10 to 55 Hz at double amplitude of 1 mm	In vertical, horizontal and longitudinal directions
Use condition	Ambient temperature	-20 °C to +55 °C	Avoid icing and condensation
	Ambient humidity	35 to 85 % RH	Avoid condensation
	Storage temperature	-30 °C to +80 °C	Avoid icing and condensation
Terminal screw fasten torque		0.3 to 0.5 N·m ( 3 to 5 kgf·cm )	
Coil surge absorber		Diode ( 1 A, 400 V )	
Cross connection protecting diode		1 A, inverse voltage 400 V	
Unit weight		Approx. 100 g	

- Notes) 1: Dielectric strength and insulation resistance are initial values.  
 2: Condensing occurs when the unit relay is exposed to sudden temperature change in a high temperature and high humidity atmosphere. This may cause some troubles like insulation failure of the socket or the PC board. Take care under this condition.  
 3: Below 0 °C, condensing water can freeze and cause socket contact failures and other problems. Take care under this condition.

## REFERENCE DATA

### 1. Max. switching capacity (output)

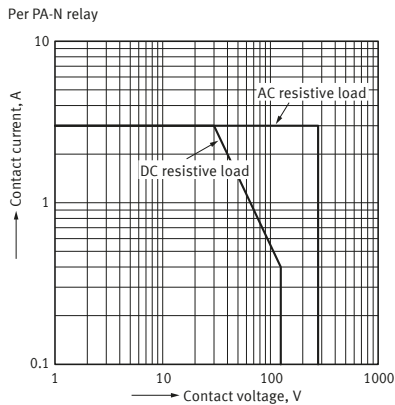

### 2. Load current vs. ambient temperature characteristics ( DC only )

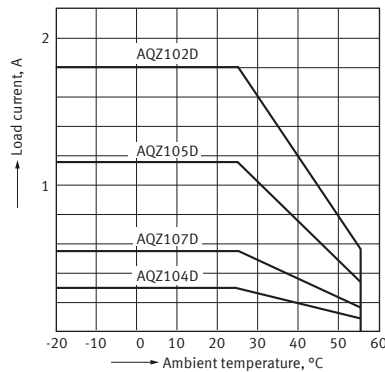

### 3. Load current vs. ambient temperature characteristics ( AC/DC dual use )

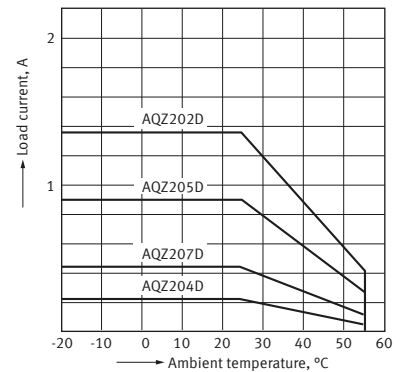

# RT-3 UNIT RELAY ( PA-N relay type ) /4-POINT TERMINAL ( Without relay type )

## DIMENSIONS ( Unit: mm )

**CAD** The CAD data of the products with a " CAD " mark can be downloaded from our Website.

**CAD**

External dimensions

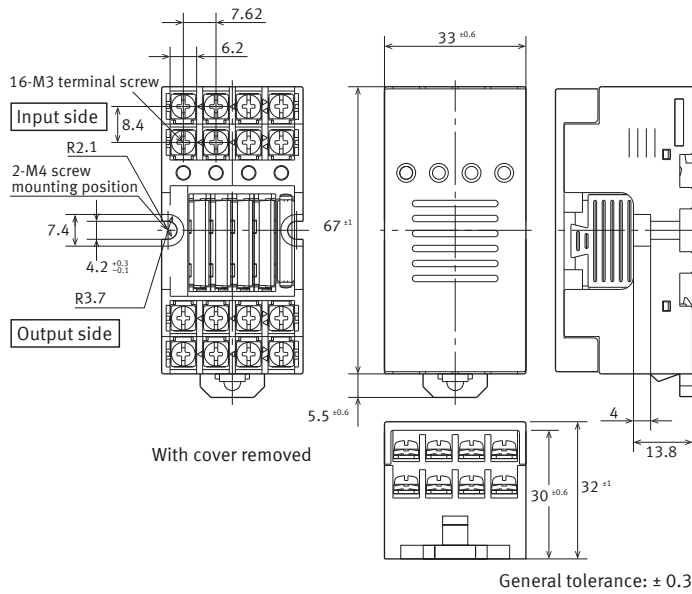

Schematic

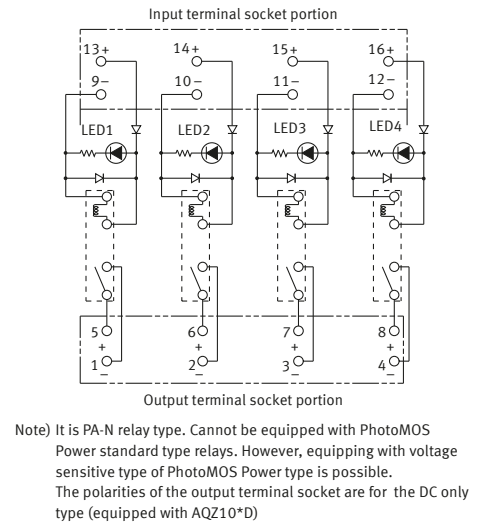

Mounting hole pattern

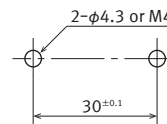

## GUIDELINES FOR USAGE

- For cautions for use, please read " GUIDELINES FOR RELAY USAGE " . [https://industrial.panasonic.com/ac/e/control/relay/cautions\\_use/index.jsp](https://industrial.panasonic.com/ac/e/control/relay/cautions_use/index.jsp)

# CAUTIONS FOR USE RT-3 UNIT RELAY 4-POINT TERMINAL

■ Never install modules ( relays ) into this product other than those designated. Doing so will cause malfunction, breakdown, and breakdown of the connected product.

■ If a unit is dropped, be sure to check its external appearance and characteristics before using it.

■ The operate and release voltage values when equipped with PA-N relays are based on the relay terminals being face down.  
( RT-3 Unit relay ( PA-N type ), 4-point Terminal )

■ Switching lifetime ( PA-N relay )  
This characteristic depends on the relay and is effected by coil driving circuit, load type, activation frequency, activation phase, ambient conditions and other factors.

Also, be especially careful of loads such as those listed below.

1) When used for AC load-operating and the operating phase is synchronous, rocking and fusing can easily occur due to contact shifting.

2) Frequent switching under load condition When high frequently switched under load condition that can cause arc at the contacts, nitrogen and oxygen in the air is fused by the arc energy and  $\text{HNO}_3$  is formed. This can corrode metal materials. Three countermeasures for these are listed here.

- ( 1 ) Incorporate an arc-extinguishing circuit.
- ( 2 ) Lower the operating frequency
- ( 3 ) Lower the ambient humidity

## ■ Operating environment

1) Keep the product as far away as possible from power cables, high tension equipment, power equipment, equipment with transmitting devices such as amateur radios, or equipment which generates a large switching surge.

2) The main unit is made of resin; therefor, do not use it in areas where it may come in contact with ( or be exposed to ) organic solvents such as gasoline, thinner, and alcohol, or strong alkaline substances such as ammonia and caustic soda.

3) Do not use the product in areas where it may be exposed to flammable gases, corrosive gases, excessive dust, or moisture, or areas where it may be subjected to strong vibration or shock.

## ■ Installing and removing the module

1) Firmly insert the module into the socket with the terminals going in the direction of the blade receptacles.

2) The module can be easily removed using the removal key ( APA801 ). The removal key ( APA801 ) is included in 4-point Unit Relay and 4-point Terminal.  
If you lose it, you can purchase APA801 separately as accessories.

① Insert the removal key ( APA801 ) into the socket slots.

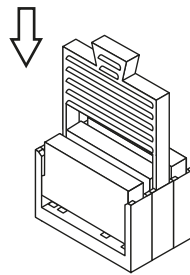

② Pull the removal key ( APA801 ) up to remove the module.

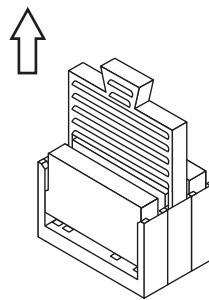

③ Slide the removal key ( APA801 ) off of the module.

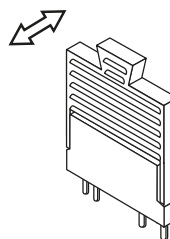

# CAUTIONS FOR USE RT-3 UNIT RELAY 4-POINT TERMINAL

## ■ Wiring and circuit configuration

- 1) Perform wiring according to the internal schematic. Take care not to make any mistakes. In particular, with the RT-3 Unit relay ( PA-N relay type ) and 4-point terminal, be careful of the polarity on the output side when equipped with AQZ10\*D ( DC type ). Also, with the RT-3 Unit relay ( PhotoMOS Power type ), be careful of the polarity on the output side of the DC type ( RT3SP1-\*\*\*V for type equipped with AQZ102 ).

- 2) We recommend the use of wire-pressed terminals for connection to the terminal portion.

### ● Example of applicable wire-pressed terminal

Company Name	Part Name	Applicable wire-pressed terminal
J.S.T. Mfg Co., Ltd.	1.25 to C3A	0.25 to 1.65 mm <sup>2</sup>

- 3) When the load is inductive, limit spike voltages generated from the load to less than the maximum load voltage.

Typical circuits are shown below.

- ① Add a clamp diode to the load.

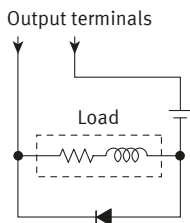

- ② Add an R-C snubber to the load.

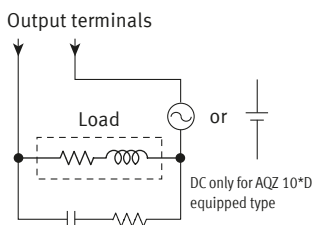

- ③ Add a varistor between the output terminals.

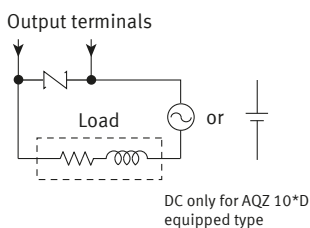

- 4) Even if spike voltages generated from the load are limited by a clamp diode or R-C snubber, inductances in long circuit wires will still create spike voltages. Keep wires as short as possible to minimize inductance.

## ■ Installation

- 1) Perform mounting hole cutout according to the panel cutout drawings.
- 2) When installing the unit on a DIN rail, use the DIN rail locking lever on the side of the unit. Installation is accomplished by simply fitting the unit onto the rail and pressing gently.

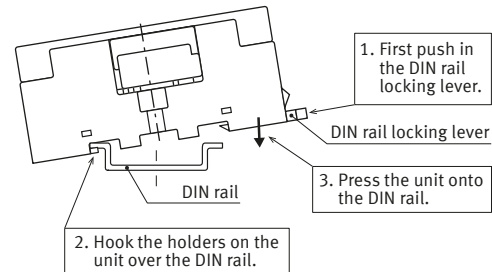

- 3) To remove the unit from the DIN rail, use a flat head screwdriver to pull out the DIN rail locking lever.

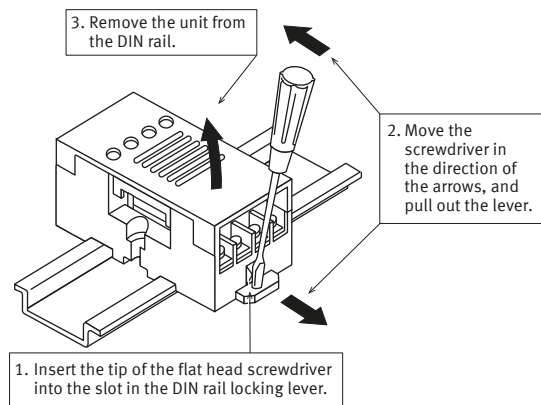

## ■ Transporting and storage

- 1) If the product is subjected to extreme vibration while being transported, the relays may become detached, the lead may become bent, and the unit may become damaged. Handle the carton and case with care.

- 2) If the product is stored in an extremely adverse environment, visible defects and deterioration of performance characteristics may result. We recommend the following storage conditions.

- Temperature: 5 to 30 °C
- Humidity: Max. 60 % R.H.
- Environment: No hazardous substances such as sulfurous acid gases and little dust.

## ■ When equipped with PhotoMOS Power voltage drive type [ RT-3 Unit relay ( PA-N relay type ), 4-point Terminal ]

Since the PhotoMOS Power voltage sensitive type does not require the current-controlling resistance on the input side, it can be used together with PA-N relays on RT-3 unit relay ( PA-N relay type ).

When connecting PhotoMOS Power voltage sensitive types, since it will be a close connection, it will be necessary to be careful of load currents. Be sure to refer to the information given regarding "Load currents vs ambient temperature characteristics" in the precautions given for use of 4-point terminals.



# CAUTIONS FOR USE RT-3 UNIT RELAY 4-POINT TERMINAL

## TERMINAL BLOCK

We recommend using wire-pressed terminals for connection to the terminal portion.

● **Applicable electrical wire**

0.25 to 1.65 mm<sup>2</sup>

● **Applicable wire-pressed terminals ( mm )**

Company Name	Part Name	Part Name
J.S.T. Mfg Co., Ltd.	1.25 to C3A	1.25 to 3
NICHIFU	1.25Y to 3N	1.25 to 3
Nippon Tanshi Co., Ltd.	VD1.25 to 3L	R1.25 to 3

## ACCESSORIES

■ **Short circuit plate for RT-3 Unit relay**

Use when you want to bridge terminals.

< With insulator >



AY3802

External dimensions ( mm )

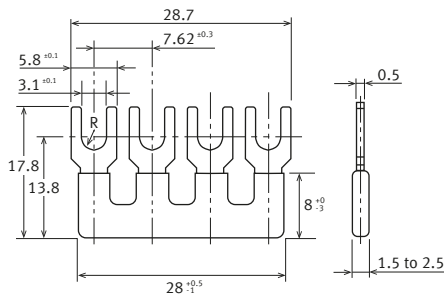

General tolerance: ± 0.5

< Without insulator >



AY3803

External dimensions ( mm )

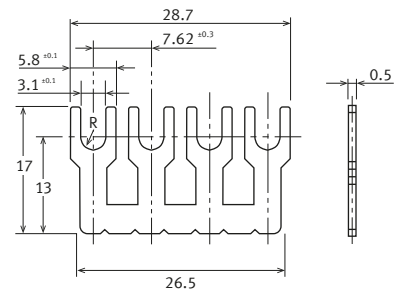

General tolerance: ±0.5

■ Global Sales Network Information: [industrial.panasonic.com/ac/e/salesnetwork](https://industrial.panasonic.com/ac/e/salesnetwork)

---

**Panasonic**  
INDUSTRY

**Panasonic Industry Co., Ltd.**

Electromechanical Control Business Division

■ 1006, Oaza Kadoma, Kadoma-shi, Osaka 571-8506, Japan  
[industrial.panasonic.com/ac/e/](https://industrial.panasonic.com/ac/e/)